

# SANDIA REPORT

SAND2014-2342  
Unlimited Release  
March 2014

## Analyses in Support of Risk-Informed Natural Gas Vehicle Maintenance Facility Codes and Standards: Phase I

Isaac W. Ekoto<sup>1</sup>, Myra L. Blaylock<sup>1</sup>, Christine A. LaFleur<sup>1</sup>, Jeffery L. LaChance<sup>1</sup>,  
Douglas B. Horne<sup>2</sup>

<sup>1</sup>Sandia National Laboratories

<sup>2</sup>Clean Vehicle Education Foundation

Prepared by  
Sandia National Laboratories  
Albuquerque, New Mexico 87185 and Livermore, California 94550

Sandia National Laboratories is a multi-program laboratory managed and operated by Sandia Corporation, a wholly owned subsidiary of Lockheed Martin Corporation, for the U.S. Department of Energy's National Nuclear Security Administration under contract DE-AC04-94AL85000.

Approved for public release; further dissemination unlimited.



**Sandia National Laboratories**

Issued by Sandia National Laboratories, operated for the United States Department of Energy by Sandia Corporation.

**NOTICE:** This report was prepared as an account of work sponsored by an agency of the United States Government. Neither the United States Government, nor any agency thereof, nor any of their employees, nor any of their contractors, subcontractors, or their employees, make any warranty, express or implied, or assume any legal liability or responsibility for the accuracy, completeness, or usefulness of any information, apparatus, product, or process disclosed, or represent that its use would not infringe privately owned rights. Reference herein to any specific commercial product, process, or service by trade name, trademark, manufacturer, or otherwise, does not necessarily constitute or imply its endorsement, recommendation, or favoring by the United States Government, any agency thereof, or any of their contractors or subcontractors. The views and opinions expressed herein do not necessarily state or reflect those of the United States Government, any agency thereof, or any of their contractors.

Printed in the United States of America. This report has been reproduced directly from the best available copy.

Available to DOE and DOE contractors from

U.S. Department of Energy  
Office of Scientific and Technical Information  
P.O. Box 62  
Oak Ridge, TN 37831

Telephone: (865) 576-8401  
Facsimile: (865) 576-5728  
E-Mail: [reports@adonis.osti.gov](mailto:reports@adonis.osti.gov)  
Online ordering: <http://www.osti.gov/bridge>

Available to the public from

U.S. Department of Commerce  
National Technical Information Service  
5285 Port Royal Rd.  
Springfield, VA 22161

Telephone: (800) 553-6847  
Facsimile: (703) 605-6900  
E-Mail: [orders@ntis.fedworld.gov](mailto:orders@ntis.fedworld.gov)  
Online order: <http://www.ntis.gov/help/ordermethods.asp?loc=7-4-0#online>



SAND2014-2342  
Unlimited Release  
March 2014

# **Analyses in Support of Risk-Informed Natural Gas Vehicle Maintenance Facility Codes and Standards: Phase I**

Isaac W. Ekoto  
Hydrogen and Combustion Technologies  
Sandia National Laboratories  
7011 East Avenue, MS 9052  
Livermore, CA 94550

Myra L. Blaylock  
Thermal/Fluid Science & Engineering  
Sandia National Laboratories  
7011 East Avenue, MS 9957  
Livermore, CA 94550

A. Christine LaFleur and Jeffery L. LaChance  
Risk and Reliability Analysis  
Sandia National Laboratories  
P.O. Box 5800, MS 0748  
Albuquerque, NM 87185

Douglas B. Horne  
DBHORNE LLC  
Clean Vehicle Education Foundation  
6011 Fords Lake Ct.  
Acworth, GA 30101

# Abstract

Safety standards development for maintenance facilities of liquid and compressed gas fueled large-scale vehicles is required to ensure proper facility design and operation envelopes. Standard development organizations are utilizing risk-informed concepts to develop natural gas vehicle (NGV) codes and standards so that maintenance facilities meet acceptable risk levels. The present report summarizes Phase I work for existing NGV repair facility code requirements and highlights inconsistencies that need quantitative analysis into their effectiveness. A Hazardous and Operability study was performed to identify key scenarios of interest. Finally, scenario analyses were performed using detailed simulations and modeling to estimate the overpressure hazards from HAZOP defined scenarios. The results from Phase I will be used to identify significant risk contributors at NGV maintenance facilities, and are expected to form the basis for follow-on quantitative risk analysis work to address specific code requirements and identify effective accident prevention and mitigation strategies.

## **Acknowledgments**

The authors gratefully acknowledge Bill Houf (SNL – Retired) for his assistance with the set-up and post-processing of the numerical simulations.



# Contents

1.	Introduction	11
1.1.	Historical Code Development Process.....	11
1.2.	Proposed Code Development Research .....	12
1.3.	Objectives and Scope .....	13
2.	Existing Code Requirements	15
2.1.	Ventilation.....	15
2.2.	Pit Ventilation .....	16
2.3.	Gas Detection.....	16
2.4.	Ignition Sources .....	16
2.5.	Electrical Classification .....	16
2.6.	Preparing a Vehicle for Repair .....	17
2.7.	Maintenance and Decommissioning of Vehicle Fuel Containers.....	17
3.	Conventional NGV Repair Facility HAZOP	19
3.1.	Background Assumptions .....	19
3.2.	HAZOP Methodology.....	20
3.3.	HAZOP Results .....	22
4.	Scenario Analysis	23
4.1.	Maintenance Garage .....	23
4.2.	Simulation Boundary Conditions.....	24
4.2.1.	Dormant LNG Blow-off Scenario .....	24
4.2.2.	CNG and LNG Fuel System Line Cracking .....	25
4.2.3.	Mechanical Failure of a Thermally Activated PRD .....	26
4.3.	CFD Scenario Results.....	26
4.3.1.	Dormant LNG Blow-off Scenario Results.....	27
4.3.2.	CNG and LNG Fuel System Line Cracking Results .....	29
4.3.3.	Full-Scale Tank Blow-Down due to a Mechanical Failure of the PRD .....	31
5.	Summary and Conclusions	35
	References	37
	Appendix A: HAZOP Data Sheets	41
	Appendix B: Supplemental CFD Simulation Data	45
	Distribution	49

# Figures

Figure 1: Typical large-duty LNG vehicle fuel system schematic major components highlighted. Note that system isolation and overpressure protection is after the heat exchanger so that all fuel system natural gas is gas phase. .... 21

Figure 2: Typical large-duty CNG vehicle fuel system schematic with most major components. Note the fail-close solenoid valves on all storage tanks isolate natural gas from the fuel system during regular maintenance..... 21

Figure 3: Schematic of the NGV maintenance facility used for the simulations. The roof had a 1:6 pitch and had layouts with and without 9 evenly spaced, horizontal supports. Two circulation vents were located on the smaller building side-walls, with one placed low and the other high to maximize room currents. .... 24

Figure 4: NGV Maintenance facility natural gas mole fraction contours at 10, 60, and 306 seconds into the release for the facility layouts without (top) and with (bottom) roof supports for the LNG blow-off scenario. Velocity maps are also shown along the facility centerline to illustrate the impact of room currents on flow dispersion. .... 27

Figure 5: Time-history of the total natural gas flammable mass and volume for the LNG blow-off scenario. Note that the simulation for the scenario without ventilation in the facility without support beams was terminated 100 seconds into the release once steady flammable concentrations had been firmly established. .... 28

Figure 6: Grid convergence test that used the coarse (195,000 nodes) and fine (2.5 million nodes) grids for the LNG blow-off scenario with roof rafters to ensure repeatable results. .... 29

Figure 7: Mass flow rate time-history plot for the CNG line cracking scenario calculated from NETFLOW. .... 29

Figure 8: Maintenance facility natural gas LFL iso-contours at 2.5 (top), 10 (center), and 30.0 (bottom) seconds into the release for the layouts without roof supports for the CNG line cracking scenario. .... 30

Figure 9: Time-histories of total natural gas flammable mass and volume for the CNG blow-down scenario. .... 31

Figure 10: Mass flow rate time-history for the CNG tank blow-down scenario calculated from NETFLOW for a 700 liter tank pressurized with natural gas to 248 bar and released through an a 6.2 mm diameter orifice. Note that the tank volume was 50% greater than normal to simulate a worst case scenario. .... 31

Figure 11: Maintenance facility natural gas LFL iso-contours for the CNG tank blow-down scenario from a 700 liter tank pressurized to 248 bar for the facility layout with active ventilation, roof support beams, and a vertical release into the enclosure. Time histories of flammable mass and volume are also included..... 33



Figure 12: NGV Maintenance facility natural gas mole fraction contours at 10, 60, and 306 seconds into the release for the facility layouts without roof supports for the LNG blow-off scenario. .... 45

Figure 13: NGV Maintenance facility natural gas mole fraction contours at 10, 60, and 306 seconds into the release for the facility layouts with roof supports for the LNG blow-off scenario. .... 46

Figure 14: Maintenance facility natural gas mole fraction contours at 2.5 (top) and 30.5 (bottom) seconds into the release for the layouts without roof supports for the CNG line cracking scenario. .... 47

## Tables

Table 1: Typical service and maintenance activities ..... 19

Table 2: Operation States of CNG and LNG-Fueled Vehicles..... 20

Table 3: HAZOP Results selected for modeling analyses ..... 22

# Nomenclature

ACH	Air Changes per Hour
AHJ	Authority Having Jurisdiction
API	American Petroleum Institute
BLEVE	Boiling Liquid Expanding Vapor Explosion
CDF	Cumulative Distribution Function
CNG	Compressed Natural Gas
CVEF	Clean Vehicle Energy Foundation
DOE	Department of Energy
EIGA	European Industrial Gas Association
HAZOP	Hazardous and Operability Study
IBC	International Building Code
ICC	International Code Council
IFC	International Fire Code
IMC	International Mechanical Code
ISO	International Standards Organization
LFL	Lower Flammability Limit
LNG	Liquid Natural Gas
NFPA	National Fire Protection Agency
NGV	Natural Gas Vehicle
NIST	National Institute of Science and Technology
OEM	Original Equipment Manufacturer
PRD	Pressure Relief Device
PRV	Pressure Relieve Valve
QRA	Quantitative Risk Assessment
SDO	Standards Development Organization
SNL	Sandia National Laboratories

# 1. Introduction

The growth of natural gas vehicle (NGV) fleets in recent years, especially for interstate commerce, has increased the need for additional gaseous fuel friendly maintenance facilities across the country. The NGV industry has largely focused its efforts on development of vehicles and fueling infrastructure, while issues with maintenance facility design and operation have been left to fleet owners. Sometimes in conjunction with paid consultants, fleet owners have had to use their own internal staff to interpret the intent of applicable codes to develop a facility design for liquefied natural gas (LNG) and/or compressed natural gas (CNG) applications that will be approved by the authority having jurisdiction (AHJ). The process can be difficult since the codes allow “performance-based” designs but provide little actual design guidance and have requirements that necessitate expert evaluation of expected hazardous conditions. Guidance that provides a better understanding of the code committee intent when the language was drafted is needed in order to apply those requirements across a diverse (e.g., ceiling height, layout, roof construction, heating, ventilation electrical) suite of maintenance facilities.

## 1.1. Historical Code Development Process

Relevant codes for NGV maintenance facility operations have been developed over a number of years beginning in the late 1990s after a series of unintended releases from first generation pressure relief devices (PRDs) installed on CNG storage cylinders. The codes were initially written as prescriptive requirements and are now moving towards performance documents with the requirements based on assumed hazards determined from the cumulative expert knowledge and field experience of standards development organization (SDO) code committee members. Code requirements for CNG and LNG vehicles have key distinctions based on historical user experience with the respective technologies.

The initial wave of PRD failures were either the result of models improperly selected for the design working pressure or some sort of design flaw. As a result of these incidents, the basic hazard for CNG systems was identified as the unintended release and subsequent ignition of natural gas while the vehicle is in the repair garage. The code committees assumed that the reasonable release amount was 150% of the total contents from the largest cylinder on the vehicle, with the extra 50% considered to be a safety factor. Since CNG cylinder PRDs are designed to only relieve during a fire, and not due to spurious in-cylinder pressure increases, PRD design standards were quickly revised. Since then, PRDs have performed as expected to protect the cylinder during a fire with few recorded failures; however, fire protection codes have not revised the assumed release amount based on the largest cylinder size. Such a requirement could promote unintended consequences, such as the use of a larger number of smaller cylinders, which can paradoxically increase overall system risk due to the increased number of failure points. The quantification of the hazard level for CNG vehicles is part of an ongoing study and will be submitted to the relevant code committees for reconsideration of existing requirements. It should be noted that the Clean Vehicle Education Foundation (CVEF) is currently investigating a series of PRD releases from imported cylinder valves rated at 260 bar that include both thermal and rupture disc PRDs. Since the rupture disc PRDs and valves are not suitable for the US 300 bar working pressures, CVEF is preparing a safety bulletin to stop the use of these valves.

For LNG vehicles, existing codes do not define a specific release scenario but instead assume two release types. The basic hazard is the possible ignition of gas released from the LNG tank relief valve due to pressure building as the contents warm over a period of time. Vacuum insulated LNG tanks are designed to have a ‘hold time’ of up to several days before the pressure builds to the relief setting. Typically the LNG tank pressure would build at a rate of about 103 kPa (15 psig) per day giving a ‘hold-time’ of about seven days, which is a normal operating parameter of LNG tanks. There are operating procedures that can greatly reduce the probability of a LNG tank PRD release during planned maintenance/repair operations, such as operating the vehicle to reduce the pressure in the tank, and monitoring the pressure and rate of pressure rise in the tank before entering the repair garage. The codes also have requirements that address possible liquid-phase LNG spills in the maintenance facilities that can subsequently flash-boil; however, there are no reported incidents within the historical records.

## **1.2. Proposed Code Development Research**

To develop a comprehensive analysis into existing regulatory issues regarding NGV maintenance facility operations—discussed in greater detail in the following section—the CVEF has partnered with Sandia National Laboratories (SNL) to take advantage of Sandia’s extensive experience performing similar analyses in support of hydrogen refueling infrastructure [1]. The collective expertise in code interpretation, CFD modeling, sensitivity studies, hazard analysis, NGV fuel systems and facility operations are leveraged to develop guidelines for modification and construction of maintenance facilities. The scope of work has been split into two phases. The current report discusses the results and conclusions from Phase I, which involves a detailed survey of existing codes and regulations and quantification of the risk to personnel and property from any credible hazards. Phase II will be a follow-on study where the understanding generated in Phase I is leveraged to develop best practices to mitigate the identified hazards and design guidance based on facility configurations, along with a proposal for recommended changes to existing fire protection codes.

Note that much of the existing code language was developed from ‘rule of thumb’ based on user experience, without risk-informed analysis of potential hazards as recommended by the Fire Protection Research Foundation [2]. A risk-informed process, or quantitative risk assessment (QRA), leverages insights obtained from qualitative hazardous and operability study (HAZOP) combined with more quantitative metrics to establish code requirements. For NGV maintenance facility operations these metrics include the results of deterministic analyses for select accident scenarios, leakage frequency events, and safety margins to account for uncertainties. The QRAs enable identification of high-risk scenarios for NGV maintenance facility operations along with the dominant causal factors. Furthermore, QRAs can be used to evaluate the effectiveness of accident prevention and mitigation strategies so that risk can be reduced to acceptable levels. The impact of physical or engineered mitigation solutions for specific hazards must be balanced against procedural techniques that, while cheaper and easier to implement, also introduce the additional risk of human error [3].

### 1.3. Objectives and Scope

The Phase I work described in the current report has been separated into two activities: (1) A HAZOP based on SDO expert advice was developed, which included a comprehensive review of NGV onboard fuel system components and an analysis of recorded historical incidents; and (2) Leverage Sandia's validated computational modeling capabilities [4, 5] to evaluate credible release scenarios based on the HAZOP analysis. Although the justification is laid out later in the text, scenario details are summarized below:

- A fully fueled LNG vehicle assumed to be left dormant in a NGV maintenance facility for a duration that exceeds the onboard storage 'hold time' (~7 days). The resulting pressure buildup causes the pressure relief valve (PRV) to relieve, which leads to a controlled release of cool gas phase natural gas (~160 K) through a vertically orientated vent stack until the tank pressure falls below to the PRV seat pressure.
- Pressurized residual natural gas downstream of the system isolation and heat exchanger of an LNG vehicle is released into the facility when the fuel system is purged by a maintenance technician.
- Pressurized residual natural gas downstream of the system isolation of a CNG vehicle is released into the facility when the fuel system is purged by a maintenance technician. This scenario is identical to the previous scenario except that the fuel systems for CNG systems have roughly double the volume and pressures that are roughly an order of magnitude larger.

A fourth scenario was also performed where the entire contents of a 700 L, fully pressurized (250 bar) CNG cylinder were released into the NGV maintenance facility due to the activation of a thermally triggered PRD. New safeguards such as the use of dual activated PRD valves that use parallel but independently activated PRDs, should make inadvertent activation unlikely. Nonetheless, the recent unintended PRD releases described earlier highlight the possibility for human error, and accordingly this event is deemed to be a basic worst-case hazard used by code development committees.

The present report summarizes existing code requirements for NGV repair facilities to highlight inconsistencies from competing codes and identify code requirements that need quantitative analysis into their effectiveness. The HAZOP analysis is summarized in Section 3 and is expected to form the basis for follow-on QRA work on specific code requirements highlighted in Section 2. Scenario analysis based on the computational modeling results are discussed in Section 4. It should be noted that the consequence analysis does not extend beyond the scenarios described above and that without the follow-on QRA work there is no way to establish whether these are the most impactful possible scenarios. Finally, a summary of all results along with conclusions based on the data are given in Section 5. These results are meant to inform SDOs on the technical requirements for safe repair shop facility and design, with the hope for improved code harmonization and the implementation of scientifically defensible codes and standards.



## 2. Existing Code Requirements

Existing code requirements have been thoroughly documented by CVEF [6], and are summarized here. The dominant US and international codes that cover vehicle maintenance facilities are the International Code Council's Fire (IFC), Mechanical (IMC), and Building (IBC) codes [7-9], along with NFPA codes 30A, 52, and 88A [10-12]. It is important to note that these codes are voluntarily adopted by states on a case-by-case basis and enforced by the local Authority Having Jurisdiction (AHJ). Since the local AHJ has the ability to enforce additional requirements beyond the national codes, they should be consulted early as part of the initial evaluation. The codes discussed below *only apply* to major repair facilities, with both NFPA 30A and the IFC exempting minor repair facilities from all code requirements specific to CNG and LNG.

- IFC 2211.7 exempts garages that do not work on the vehicle fuel system or use open flames (i.e., welding) from all additional requirements.
- NFPA 30A exempts garages that do not perform engine overhauls, painting, body and fender work, and any repairs requiring draining vehicle fuel tanks from all additional requirements. The maintenance work that can be done without any modifications to the facility include lubrication, inspection, engine tune-ups, replacement of parts, fluid changes, brake system repairs, tire rotation, and similar routine maintenance.

When a maintenance facility considers adding NGVs to their operations, an analysis of maintenance tasks by type as a percentage of the overall activities should be performed, which can help determine if the facility could be divided into major and minor repair areas. With proper physical separation, the codes require only that those facility areas designated as major repair areas to be subject to the additional NGV requirements.

### 2.1. Ventilation

Table 403.3 of the IMC [8] requires all vehicle repair garages, regardless of fuel type or maintenance performed, to have a ventilation rate of 229 lpm per square meter of floor area (0.75 cfm/ft<sup>2</sup>). However, NFPA 88A has a more stringent requirement of 305 lpm/m<sup>2</sup> (1.0 cfm/ft<sup>2</sup>) for enclosed parking garages that house liquid and gaseous-fueled vehicles that should be considered as the base rate since even for minor repair garages since vehicles could be parked while awaiting repair. Where mechanical ventilation is required by IFC 2211.7, it must operate continuously except when it is either interlocked with a gas detection system for LNG or electrically interlocked with the lighting circuit for CNG applications.

There is a discrepancy between NFPA 30A and IFC in that NFPA 30A only requires ventilation for fuel dispensing areas within the maintenance facility. However, IFC 2211.7 uses similar language for CNG repair facilities that assumes indoor fueling will always be part of the repair facility—there is a requirement that the “system shall shut down the fueling system” if the ventilation fails. The mechanical ventilation requirement is 5 air changes per hour (ACH), with two exceptions: (1) work is not to exchange parts and the maintenance requires no open flame or welding and (2) repair garages with AHJ approved natural ventilation. Clarification is needed on these IFC requirements—note that NFPA separates indoor dispensing from repair facility

requirements. With regards to LNG fuels NFPA 30A has an additional requirement that repair garages have a gas detection system interlocked to the mechanical ventilation.

## **2.2. Pit Ventilation**

Ventilation requirements for pits, below grade, and subfloor work areas are part of the basic requirements for liquid fuels where flammable vapors may accumulate. For existing facilities, this requirement should already be met. However, the IFC requires ventilation flow rates of 457 lpm/m<sup>2</sup> (1.5 cfm/ft<sup>2</sup>) while NFPA 30A requires 305 lpm/m<sup>2</sup> (1.0 cfm/ft<sup>2</sup>), with neither code containing specific requirements to CNG or LNG. Until the codes are harmonized, the local AHJ must specify the applicable rate for each facility. While experience has shown that there is a very low probability of a release of LNG liquid, the cold vapor release may initially be heavier than air and persist in a subgrade area before eventually warming up and rising due to buoyancy. The existing ventilation requirement for liquid fuels should be adequate for the addition of LNG to major repair facilities with approval of the local AHJ. Note that pit requirements were not considered for the present analysis, but the potential for accumulation of cool LNG within a pit is something that should be considered for future work.

## **2.3. Gas Detection**

There is no requirement for gas detection in either major or minor repair garages where odorized CNG vehicles are maintained. However, both IFC 2211.7 and NFPA 30A require approved gas detection systems for major repair garages servicing LNG vehicles. Specific requirements under these codes for gas detection installation and operation are similar and may require the expertise of a gas detection design engineer for optimal performance.

## **2.4. Ignition Sources**

The IFC does not have any specific requirements for CNG and LNG repair garages with respect to ignition sources although for liquid fuels IFC 2211.3 does require that ignition sources be restricted from the space within 0.46 m (18") of the floor. The liquid fuel ignition source requirement is likewise the standard requirement in the IBC, IMC and NFPA 70. Nonetheless, it is doubtful these requirements should likewise be applicable to CNG/LNG due to the differences in dispersion characteristics. In NFPA 30A, the restrictions on heating equipment in major repair garages only apply to areas where ignitable mixtures may be present. At the moment, the only way to quantify where these flammable mixtures exist is to perform computational fluid dynamic (CFD) modeling of credible CNG and LNG releases requires within representative facility geometries. There is a need to develop and validate reduced order methods that are expedient and accessible to a wide range of users, but still provide a sufficient level of accuracy.

## **2.5. Electrical Classification**

While the IFC does not have specific requirements for electrical classifications of NGV repair garages, NFPA 30A Chapter 8 does include electrical classification area requirements for liquid fuel vehicles for pits and the space within 0.46 m (18") from the repair garage floor. At the moment, there is a requirement for major CNG vehicle repair garages in NFPA 30A that



classifies the area 0.46 m (18") from the ceiling as Class 1, Division 2 unless the area below the ceiling has ventilation of at least 4 ACH. While NFPA 30A is silent on classified areas for LNG in major repair garages, in practice LNG would generally be subject to the same requirements as liquid fuels in pits and as CNG in the 0.46 m (18") space below the ceiling.

When considering what constitutes a credible release, it was noted earlier that existing CNG code requirements were based on the release of 150% of the contents of the largest cylinder in the repair facility in response to a series of PRD failures in the 1990s. The PRDs have been through several design revisions since then and the last few cases of premature release were over ten years ago. A proposal has been submitted by CVEF to review these requirements in NFPA 30A 8.2.1 based on a QRA that considers the likelihood of different CNG/LNG releases and the configuration of representative maintenance facilities.

## **2.6. Preparing a Vehicle for Repair**

The only code requirement that addresses mitigation of the assumed hazards from releases of natural gas is IFC 2211.5 by: (1) Valve closures prior to maintenance to isolate CNG cylinders and LNG tanks from the fuel system balance to limit the potential fuel quantity that could be released due to damage or error during maintenance operations. (2) Operating the NGV until it stalls due to low fuel pressure in the system to further reduce the possible release volume. (3) Require the NGV fuel system be leakage tested by appropriate methods if there is a concern that the fuel system has experienced any damage. If damage is suspected the vehicle may need to be de-fueled prior to any maintenance.

## **2.7. Maintenance and Decommissioning of Vehicle Fuel Containers**

Code requirements for vehicle fuel containers are part of the maintenance requirements for vehicle mounted fuel storage containers; hence, NFPA 52 [11] should be consulted for specific requirements. Note that the latest edition (2013) incorporates several critical safety related changes for CNG cylinder maintenance based on lessons learned from incidents during maintenance operations. Also CVEF has published the document Safety Advice for Defueling CNG Vehicles and Decommissioning and Disposal of CNG Cylinders [13] These include requirements that repair facilities create specific written procedures for inspection and decommissioning of CNG cylinders and incorporate approved defueling capabilities; although no specific requirements for maintaining or venting LNG fuel tanks are given, these are considered best practice. Modifications to the maintenance facility are needed to accommodate fuel container defueling or fuel system maintenance and end of life decommissioning of CNG cylinders.



### 3. Conventional NGV Repair Facility HAZOP

The HAZOP purpose study is to identify and characterize potential hazards through a structured and systematic examination of a specific system [14, 15]. For the current study, however, the HAZOP was performed on the operational activities that take place for a heavy-duty NGV maintenance facility. A detailed analysis of generic, system components was performed to identify hazards that could be encountered in a representative facility. The HAZOP focused on failures that were the result of an unexpected or uncontrolled release of natural gas (liquid or gaseous phase), with specific hazards identified in order to characterize the associated consequences. The ultimate goal is to leverage these findings to develop industry best practices and propose improvements to existing codes. Other hazards associated with heavy-duty vehicle maintenance activities (e.g., mechanical, electrical, ergonomic, and noise) were not considered as these hazards are not unique to NGV maintenance activities.

HAZOP studies are usually performed on discrete industrial processes, with defined inputs and outputs from each process step or system component. Hazard scenarios are developed using a system of guidewords indicating relevant deviations from system design intents. For the present HAZOP to be most useful, an application-specific method was used that combined aspects of a failure mode and effects analysis with a HAZOP study, which is described further in this section. Spreadsheets that contain all identified hazard scenarios are included in Appendix A.

#### 3.1. Background Assumptions

Table 1 identifies typical activities associated with the NGV maintenance, which were used to categorize the operations into Operation States based on where they are typically conducted (Indoor or Outdoor) and the fuel system state during the maintenance activities (see Table 2). Operation State 3 (Dead vehicle storage) could occur either indoors or outdoors, so this operation state was broken up into “3in” and “3out”. Operation States 6 and 7 are differentiated based on the fuel system state. Operation State 6 represents fuel system services that require the entire fuel system to be evacuated and rendered inert (e.g., replacement of the solenoid valve on a CNG cylinder), while Operation State 7 is characterized by repair activities that can be performed with the isolation valve closed between the bulk tanks and the remainder of the fuel system.

Table 1: Typical service and maintenance activities

<b>Service Maintenance and Repair Activities</b>
Inspection of fuel storage and delivery piping, components (including PRD)
Inspection of fuel safety systems
Troubleshoot/ Testing
Exchange filters
Drain and replace fluids (non-fuel system)
Replace non fuel system component (brakes, tires, transmission, etc.)
Repair leaking fuel system
Replace fuel system components (e.g., tank, PRD, valve, plug, pressure gauge, economizer, fuel gauge coaxial cable)
Leak Testing

### 3.2. HAZOP Methodology

The HAZOP procedure involved an examination of each system component and identification of scenarios, conditions or failure modes that could lead to a release of natural gas. Typical large-duty LNG and CNG vehicle fuel systems that were analyzed are respectively depicted in Figure 1 and Figure 2. For each scenario identified, the component targeted as the source of the release is recorded in the “Component” column of the HAZOP datasheets by referring to the system and component number used in these schematic diagrams. For example, releases of LNG from the storage tank are labeled LNG-4 and releases associated with the CNG manifold are labeled CNG-5. Additionally, the relevant Operation States when the Hazard Scenario is applicable are indicated in the datasheets as well, indicated by the Operation State number from Table 2. The relevant Operation States assigned to each Hazard Scenario were based on the state of the fuel system. If no natural gas is expected to be in the manifold (CNG-5) because the isolation valve (CNG-4) is expected to be closed, then a release from the manifold is not deemed feasible for this analysis. Situations where a release is possible due to human error or failure to close the isolation valve are dealt with in the Hazard Scenarios associated with the isolation valve itself and in Hazard Scenario 37.

Table 2: Operation States of CNG and LNG-Fueled Vehicles

		<b>Operation State</b>		<b>Fuel System State</b>
<b>Outdoor</b>	<b>Preparation for Service</b>	1	Defueling	Entire fuel system (FMM and tanks) being evacuated
		2	Cracking of fuel system (FMM only)	Tank valve off, FMM being evacuated
		3out	Dead vehicle storage	Fuel system charged but idle, key-off
<b>Indoor</b>	<b>Preparation for Service</b>	3in	Dead vehicle storage	Fuel system charged but idle, key-off
		<b>Service</b>	4	Engine operation/idling (during testing, fuel run down, inspection and troubleshooting activities)
	5		Service on non-fuel systems	Tanks valve off, FMM evacuated (Run Down)
	6		Service on fuel system [Group 1]	Entire fuel system evacuated
	7		Service on fuel system [Group 2]	Tanks valve off, FMM Run Down then cracked
<b>Restart</b>	8	Fuel line refilling, connection of a small pony tank OR valve opening followed by restart	Fuel system recharging	

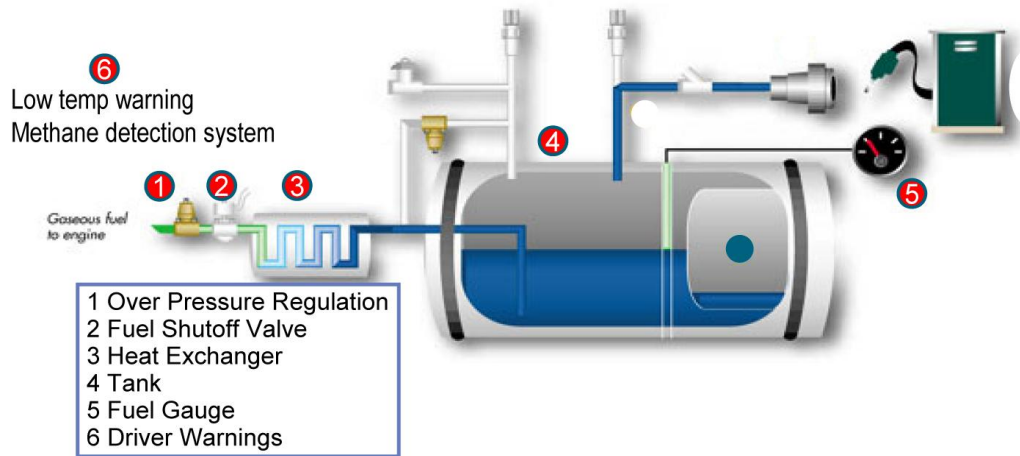

Figure 1: Typical large-duty LNG vehicle fuel system schematic major components highlighted. Note that system isolation and overpressure protection is after the heat exchanger so that all fuel system natural gas is gas phase.

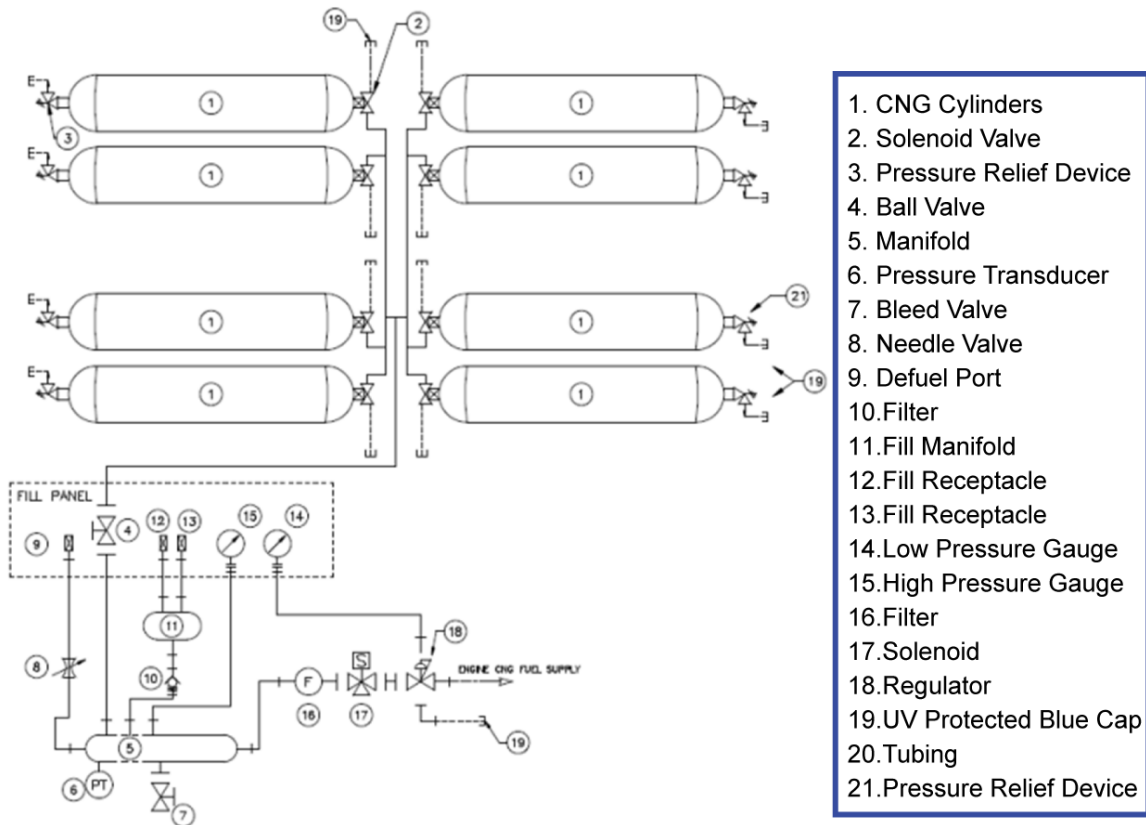

Figure 2: Typical large-duty CNG vehicle fuel system schematic with most major components. Note the fail-close solenoid valves on all storage tanks isolate natural gas from the fuel system during regular maintenance.

The potential Causes and Consequences for each Hazard Scenario are noted in the datasheets in the respective columns. Additional columns are included in the datasheets where prevention

features, detection methods, and mitigation features information can be recorded. These fields were not completed at this point, except for a couple of samples, because this data can be different for the various different Operation States applicable to each Scenario. It is intended that these scenarios will be split out individually as needed and populated as part of Phase II of this project. These measures will be used as the basis for identifying best practices and codes and standards improvements.

### 3.3. HAZOP Results

The HAZOP resulted in the identification of 41 Hazard Scenarios, although many were applicable to multiple Operation States. Three Hazard Scenarios (HAZOP numbers 7, 14, and 19) were selected for further characterization by modeling due to the intentional release of natural gas indoors. Two of these (HAZOP numbers 14 and 19) can be combined into one modeling scenario as they result in the exact same release situation: the venting of the entire CNG tank contents. HAZOP information for these scenarios is shown in Table 3. Two additional situations where natural gas is intentionally vented indoors were also selected for modeling but were not identified in the HAZOP because they are controlled releases. These situations involve the venting of residual natural gas pressure in the fuel system downstream of the isolation valve. Venting for CNG and LNG fuel systems were separately considered.

Table 3: HAZOP Results selected for modeling analyses

Modeling Scenario	HAZOP Number	Component	Operation State	Hazard Scenario	Causes	Consequences
1	7	LNG-4 (LNG tank)	3in, 4, 5, 7, 8	Overpressure of tank and proper operation of relief valve	Excessive hold time, insulation failure	Minor release of GNG
2	NA	LNG Bleed Valve	5, 7	Residual pressure is vented from fuel system downstream of isolation valve	Intentional	Minor release of GNG
3	NA	CNG -7 Bleed Valve	5, 7	Residual pressure is vented from fuel system downstream of isolation valve	Intentional	Minor release of GNG
4	14	CNG-1 (Cylinders)	3in, 4, 5, 7, 8	Overpressure of Cylinder	External fire AND successful operation of PRD	Potential catastrophic release of CNG
	19	CNG-3 (Pressure Relief Device)	3in, 4, 5, 7, 8	Failure of PRD to hold pressures below activation pressure	Mechanical defect, material defect, installation error, maintenance error	Potential catastrophic release of CNG

## 4. Scenario Analysis

To perform analyses of the identified HAZOP scenarios, a numerical modeling approach, previously validated for large-scale indoor hydrogen releases scenarios [4, 5], was adopted. The CFD solver, Fuego [16], was used to perform the natural gas release simulations from a representative NGV inside the maintenance facility. Fuego is a SNL developed code designed to simulate turbulent reacting flow and heat transfer [16] on massively parallel computers, with a primary focus on heat transfer to objects in pool fires. The code was adapted for compressible flow and combustion, and is well suited for low Mach number flows. The discretization scheme used in Fuego is based on the control volume finite element method [17], where the partial differential equations of mass, momentum, and energy are integrated over unstructured control volumes. The turbulence model was a standard two equation (k- $\epsilon$ ) turbulence model [18] with transport equations solved for the mass fractions of each chemical species, except for nitrogen which was modeled as the balance. For the calculations reported here, the first order upwind scheme was used for the convective terms. Note that methane was used as a proxy for natural gas in all simulations. For releases that involved transient blow-downs, the isentropic expansion was modeled using the NETFLOW compressible network flow analysis code [19].

Time-histories of the flammable mass and volume, along with calculations for the maximum flammable extent—i.e., the distance from the release point where flammable mixture is present—are provided for each scenario. These plots are complemented by iso-contour images of the flammable boundary for each release at select time intervals to better illustrate the development of flammable clouds. Finally, maximum possible overpressures from an ignition event are calculated to help determine the harm posed for an unintended ignition event. The overpressure results will help identify scenarios where further mitigation efforts for release and ignition events are needed.

### 4.1. Maintenance Garage

The maintenance garage was modeled as a pitched roof building (1:6 pitch) that was 30.5 m long (100'), 15.2 m wide (50') and 6.1 m tall (20'), with the roof peak located at the center and 127 cm (50") higher than the corresponding eaves (see schematic in Figure 3). Note that although the roof and main building are shown with different colors to emphasize the pitch, the enclosure was treated as a single volume. A roof layout both with and without horizontally orientated support beams was investigated to determine if the supports would cause the accumulation of flammable mixture in discrete pockets. For the condition with supports, 9 beams that were 15.2 cm wide (6") and 107 cm tall (42") were spaced 3.05 m apart (10') and ran parallel to the roof pitch. The garage contained two vents that were used for air circulation; one near the floor along one of the smaller building side-walls, and a second placed on the opposite side wall near the roof. Each vent was 0.645 m tall (25") and 3.42 m wide (131"). The NGV was modeled as a cuboid with a height and width of 2.44 m (8') and a length of 7.31 m (24'). The vehicle was centered on the building floor with the major axis aligned to the building minor axis. There was no fluid flow through this volume.

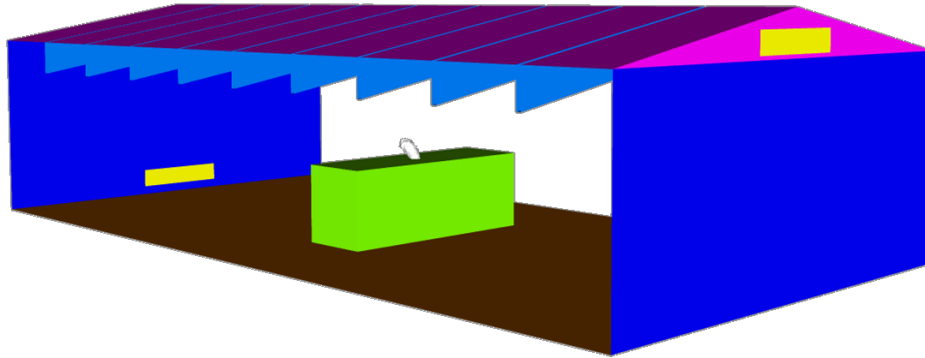

Figure 3: Schematic of the NGV maintenance facility used for the simulations. The roof had a 1:6 pitch and had layouts with and without 9 evenly spaced, horizontal supports. Two circulation vents were located on the smaller building side-walls, with one placed low and the other high to maximize room currents.

## 4.2. Simulation Boundary Conditions

The Fuego code solved the conservation equations in a time-dependent manner with gravity and buoyancy effects accounted for. A slip wall boundary condition with a constant ambient temperature (294 K) was used for all surfaces. The simulations were performed with and without mechanical ventilation to determine the impact on the development of flammable volumes in the garage. For the conditions with ventilation, a uniform air flow velocity of 2.0 m/s (6.56 ft/s) was forced through the floor vent into the enclosure, to produce 5 ACH for the enclosure. The upper enclosure exhaust vent was assigned an open boundary condition with a total pressure of 1 atm and a temperature of 294 K. A relatively coarse grid was used with 195,000 node points. For the tank blow-down simulation with higher Reynolds number exit conditions, a fine grid was used that had 2.5 million grid points and spacing that was at least half of what was used for the original grid. For example, node spacing values around the leak and near the vents were 5 cm and 15 cm for the reference coarse grid, while these values were 2 cm and 6 cm respectively for the fine mesh. For all scenarios, initial turbulence was negligible ( $k = 0.11 \text{ cm}^2/\text{s}$ ,  $\varepsilon = 1.51 \times 10^{-4} \text{ cm}^2/\text{s}^3$ ). For conditions with mechanical ventilation, air was forced into the enclosure at the prescribed 5 ACH flow rate for 750 seconds prior to the start of the release to ensure the enclosure airflow was nominally steady.

### 4.2.1. Dormant LNG Blow-off Scenario

A schematic of major LNG vehicle supply system components such as the tank, heat exchanger, fuel shutoff valve, and flow regulator are provided in Figure 1. These components are designed to limit natural gas content within the downstream fuel system. Instead, a more serious threat was deemed to be a fully fueled LNG vehicle that was left dormant in the NGV maintenance facility for a period longer than the LNG tank ‘hold time’ (~7 days). As a result, the pressure buildup would cause a PRV to relieve and release a controlled amount of cool gas phase natural gas (~160 K) through a vertically orientated vent stack until the tank pressure fell below to the PRV seat pressure. Based on industry input, the release was expected to be about 1.7% of the



cylinder contents before the PRV seats. Rather than rapidly discharging, the PRV was expected to ‘weep’ for several minutes with a nearly constant flow rate until the tank pressure reaches the seat pressure. Once reseated, the PRV likely would not relieve again for up to a day or more. Code requirements dictate the release points be from a 'safe location', which has typically been interpreted as a point that is above head height and roughly vertical. Relief vents are normally 3/8" stainless steel tubing with a plastic slip on cap to protect from rain water.

For the current scenario, saturated methane vapor was released through a vertically orientated 3/8" vent stack, whose exit was 2.44 m (8') above the floor; note that the saturated vapor exit temperature (160 K) and density (1.23 kg/m<sup>3</sup>) at atmospheric pressure were taken from the online NIST calculator [20]. The fully fueled large tank had a volume of 700 liters, and the release of 1.7% of the cylinder contents corresponded with roughly 2.3 kg (5.1 lbs) of fuel. The nominal expected flow rate was 7.58 g/s (1.0 lbs/min), which resulted in a leak duration of 306 seconds. Due to gridding constraints, the leak area was modeled as a 10 cm<sup>2</sup> (1.55 in<sup>2</sup>) square hole with an exit velocity of 61.5 cm/s (2.02 ft/s). Although the leak greatly exceeded tubing area, the plastic rain cap would result in a much larger effective leakage area; thus the 10 cm<sup>2</sup> exit area was deemed reasonable.

#### 4.2.2. *CNG and LNG Fuel System Line Cracking*

From the HAZOP there were concerns that a natural gas release may occur during the purge of a vehicle fuel system as part of regular operational maintenance. Current NGV fuel systems are equipped with fail-closed solenoid valves located either at the tank or fuel supply manifold. The solenoid valves can only be actuated open when the engine is running, which effectively isolates onboard storage from the fuel system when the engine is off—there is no recorded instance of the valves failing open. For the identified scenarios, it was assumed that maintenance is to be performed on a CNG or LNG fueled vehicle where cylinder or manifold valves were used to isolate the fuel storage from the remainder of the fuel system where the work will be performed. However, room temperature (294 K) residual natural gas downstream of the onboard storage isolation (and heat exchanger for LNG vehicles) remains in the fuel system. Prior to the start of maintenance, a technician purges the remaining natural gas by cracking a 1/2" tube fitting on the fuel system at the control panel in the engine compartment—both are assumed to be on the vehicle side at a height of 1.0 meters from the floor.

For LNG vehicles, original equipment manufacturer (OEM) specifications indicate downstream line and filter volumes are around 1 to 2 liters with a maximum pressure of 8.62 bar (125 psia). Accordingly, for this scenario the fuel system storage volume was set to 1.8 liters (110 in<sup>3</sup>) with an overall natural gas storage mass of 10.4 g. Following LaChance et al. [1], the release area was assumed to be 3% of the overall tube area, which corresponded to a 3.8 mm<sup>2</sup> hole size. For CNG vehicles, the fuel system volumes are roughly double those for LNG vehicle, and the storage pressure can equal the tank pressure. Hence, the CNG line cracking scenario was identical except that the storage volume was increased to 3.3 liters (201 in<sup>3</sup>) and the storage pressure was increased to 248 bar (3600 psia), which corresponded to an overall natural gas fuel system mass of 630 g. Note that for both scenarios it was presumed that the shutoff valve was engaged, which prevented the contents downstream of the storage isolation to escape once the line was cracked. Transient blow-downs were modeled as an isentropic expansion using NETFLOW [19]. Once again, gridding constraints limited the leak area to a 10 cm<sup>2</sup> (1.55 in<sup>2</sup>) square hole, but was

considered reasonable since the released gas was expected to first accumulate in the control panel or engine compartment before escaping into the maintenance facility.

#### 4.2.3. *Mechanical Failure of a Thermally Activated PRD*

In the event a CNG cylinder becomes engulfed in a flame, onboard storage cylinders are protected against excessive pressure buildup by a thermally triggered PRD designed to fully open without the possibility for reseal in the event of activation. Accordingly, inadvertent actuation due to some mechanical failure would result in a rapid and uncontrollable decompression of all cylinder contents. Advances such as the use of dual activated valves have been implemented to reduce the likelihood of unintended release, although there remains some nominal risk due to the potential for human error. The SDOs view such a release as a bounding event for hazard potential. For the final scenario, the entire contents of a 700 L, fully pressurized (248 bar) CNG cylinder at room temperature (294 K) was released into the NGV maintenance facility. Note that the tank volume was 50% greater than normal to simulate a worst case scenario. For convenience, the specified release point was identical to the LNG blow-off scenario. The PRD orifice diameter was set to 6.2 mm (0.24") based on the flow rate specifications of typical commercially available PRDs. At the start of the release, the valve was assumed to fully open and remain that way for the duration. Once again gridding constraints limited the initial leak to 10 cm<sup>2</sup>, and NETFLOW was used to model the transient blow-down.

### 4.3. CFD Scenario Results

The primary hazards associated with unintended natural gas releases are the maximum overpressure above ambient and the associated integrated pressure time-history or pressure impulse after the combustible gas mixes with air and ignites. Confinement, particularly with obstacles, can exacerbate overpressure and pressure impulse hazards for sufficiently small enclosures due to the volumetric expansion of gases [21], and can introduce new threats such as flying debris or building collapse [22]. Probit models for individual harm criteria are generally given a function of the expected maximum overpressure and the integrated pressure time-history or pressure impulse, along with any relevant structural details. Analytic methods to evaluate overpressure hazards from confined and vented deflagrations within enclosures generally only consider uniform air-fuel mixture compositions [21, 23-26], and not stratified environments with combustible clouds expected from the scenarios described.

Recently, Bauwens and Dorofeev [27] developed an analytic model that only considers the flammable mass quantities and enclosure volumes, without any regard to amount of mixing. Model results yielded good agreement with peak overpressure measurements from large-scale hydrogen release and deflagration experiments by Ekoto et al. [28]. Accordingly, the model was used here to estimate peak overpressure hazards based on the flammable mass prediction from the CFD simulations; pressure impulse was not considered. Note that the model assumes no instability enhancement of the flame front (e.g., acoustic) and that local blast waves were relatively minor; reasonable assumptions for leaks with small flammable volumes. Equation 1 describes how the adiabatic increase in pressure depends on the mass of hydrogen consumed:

$$\text{Eq. 1.} \quad \Delta p = p_0 \left\{ \left[ \frac{V_T + V_{NG}}{V_T} \frac{V_T + V_{NG} / \chi_{stoich} (\sigma - 1)}{V_T} \right]^{\gamma} - 1 \right\}$$

where  $p_0$  was the ambient pressure,  $V_T$  and  $V_{NG}$  were the total facility volume and expanded volume of pure methane following the release respectively,  $\chi_{stoich}$  was the natural gas-air stoichiometric mole fraction,  $\sigma$  was the expansion ratio for stoichiometric natural gas-air combustion, and  $\gamma$  was the air specific heat ratio. Note that it was convenient to define  $V_{NG}$  as the ratio of total flammable natural gas mass—which was a ready output from the FUEGO CFD simulations—to the known ambient density of pure natural gas. It was thus important to accurately predict the flammable mixture across a range of characteristic leaks. The lower (LFL) and upper flammability limits (UFL) for methane mixed with air at atmospheric conditions is 5.0 and 15.0% methane volume fraction respectively [29], while mixtures outside of this range present no possibility for combustion.

#### 4.3.1. Dormant LNG Blow-off Scenario Results

The first scenario involved a PRV release of cool natural gas through a vent stack for a fully fueled LNG vehicle that was left dormant in a maintenance facility beyond the prescribed hold-time. Natural gas mole fraction maps from the maintenance facility central plane for conditions with mechanical ventilation are illustrated in Figure 4 280 seconds after the start of the release for facility layouts with and without roof supports. Velocity maps from the maintenance facility central plane for the conditions with and without roof supports in illustrate the influence of the strong inlet flows needed to sustain the 5 ACH ventilation rate. When ventilation currents reached the vehicle side, they were deflected upward and formed a low-pressure recirculation region that was capable of bending a vertical natural gas plume toward the vent inlet. For the facility layout with roof supports, there was no substantial shape change in the flammable region.

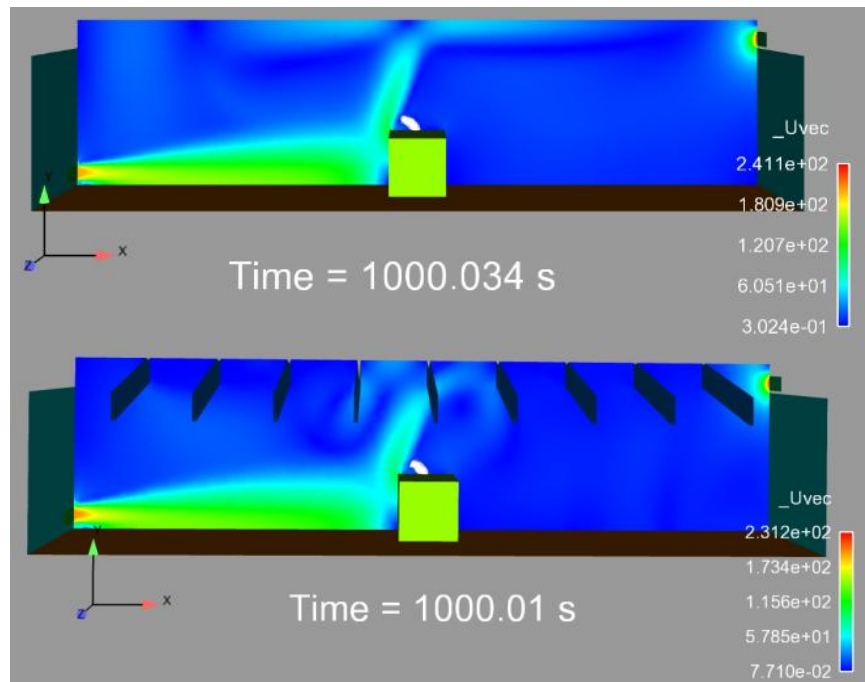

Figure 4: NGV Maintenance facility natural gas mole fraction contours at 10, 60, and 306 seconds into the release for the facility layouts without (top) and with (bottom) roof supports for the LNG blow-off scenario. Velocity maps are also shown along the facility centerline to illustrate the impact of room currents on flow dispersion.

For both scenarios, flammable natural gas was confined to a small region near the source; areas shaded in blue are too lean to combust. To more clearly illustrate this point, time-histories of the total mass and volume of flammable natural gas within the enclosure (i.e., mixture between the LFL and UFL) for each scenario is plotted in Figure 5. For the facility configuration without beams, the flammable volume and mass initially spiked to a peak value ~10 seconds after the release before assuming a nominally constant value, whereas for the facility with flammable beams the values were nominally steady throughout the release duration. Interestingly, the condition with support beams had a lower flammable mass and volume for most of the release as vortical structures induced by the support beams were able to more rapidly mix air into the release plume. Over time it appears that both the flammable mass and volume steadily increased as the cloud within the center of the maintenance facility steadily grew, although the release duration was too short for this to become a significant hazard. Note that for the conditions without ventilation the maximum for the layouts with and without support beams were 158 and 169 cm respectively. When ventilation was included, the respective flammable extents for the layouts with and without beams were reduced to 85 and 115 cm. A maximum flammable mass of 28 g occurred for the no support beams facility layout without ventilation, which corresponded to a max possible overpressure potential of 125 Pa from equation 1. According to probit models from [30] the lowest potential overpressure harm threshold is the threat of broken glass, which has a lower limit of 1 kPa. Hence, no substantial hazard is expected from this scenario.

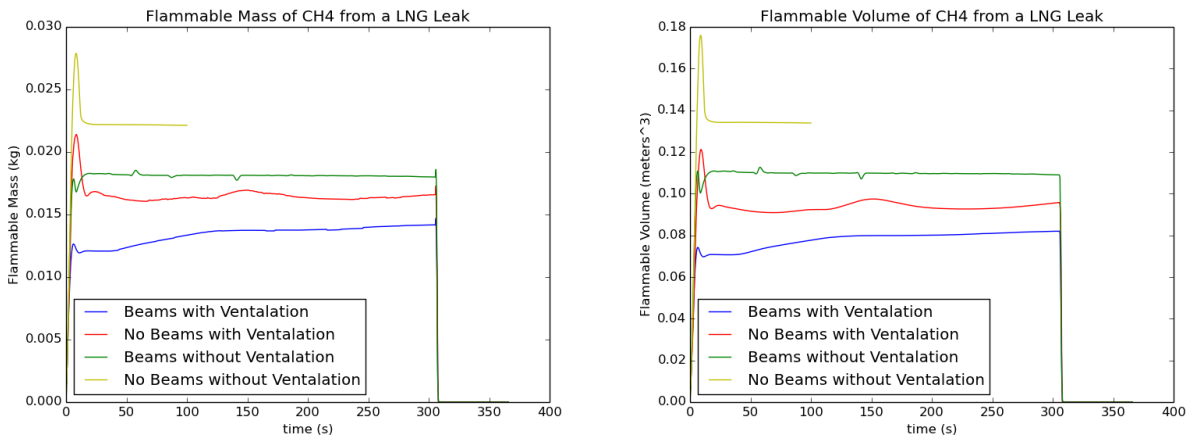

Figure 5: Time-history of the total natural gas flammable mass and volume for the LNG blow-off scenario. Note that the simulation for the scenario without ventilation in the facility without support beams was terminated 100 seconds into the release once steady flammable concentrations had been firmly established.

To ensure the simulation results were not from an artifact of the coarse grid geometry, a grid-convergence study was performed for the scenario with roof supports that was believed to be more sensitive to grid sizing. The fine grid described earlier was used to repeat the simulation and the flammable mass time-history from both simulations, and as can be seen in Figure 6 produced identical results to the simulation with the coarse grid out to just past 200 seconds into the release. From these results it is clear that simulation outputs are independent of grid sizing.

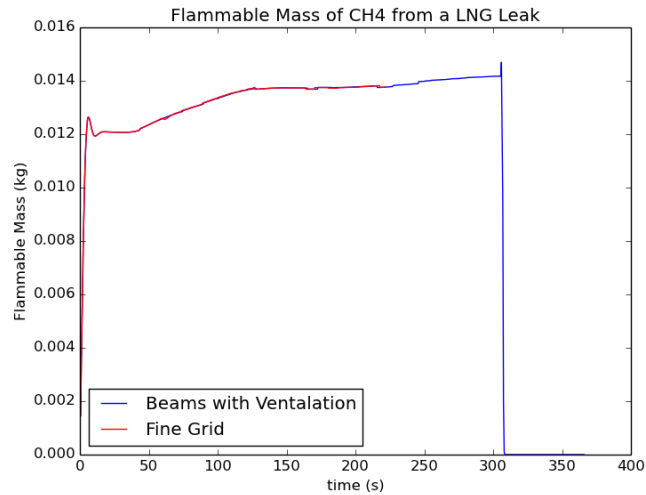

Figure 6: Grid convergence test that used the coarse (195,000 nodes) and fine (2.5 million nodes) grids for the LNG blow-off scenario with roof rafters to ensure repeatable results.

#### 4.3.2. CNG and LNG Fuel System Line Cracking Results

For the second scenario, the impact of a fuel system ½” line cracked prior to the start of maintenance operations for CNG fueled vehicles was analyzed—since the total fuel within LNG fuel systems is much lower than for CNG vehicles, only the CNG release was considered here. Moreover, only the facility layout without roof supports was considered since the plume from the side-release was not expected to be influenced by the centrally located circulation region above the vehicle. The transient blow-down was modeled via NETFLOW, with the release rate time-history provided in Figure 7.

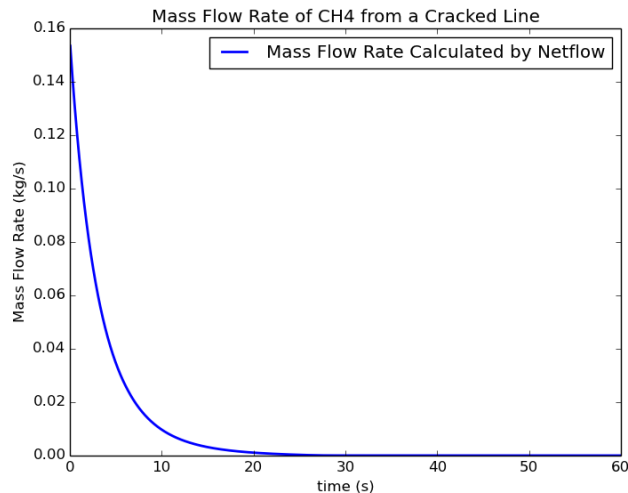

Figure 7: Mass flow rate time-history plot for the CNG line cracking scenario calculated from NETFLOW.

Center plane LFL iso-contour maps for the facility without support beams are provided at select times in Figure 8. Complementary time-history plots of the total flammable mass and volume are

included in Figure 9. By 2.9 seconds into the release when the flammable extent was greatest at 265 cm, the exit plume near the vehicle contained the peak flammable mass values (up to 100 g) due to a combination of high initial mass flow rates and limited mixing. Nonetheless, the peak flammable mass and volume values were small, which limited the possible overpressure to 0.43 kPa; well below the lowest harm threshold. Moreover, the duration of flammable mixture within the enclosure was very short, with all flammable regions diffused away by 23 seconds into the release (see Appendix B for further details).

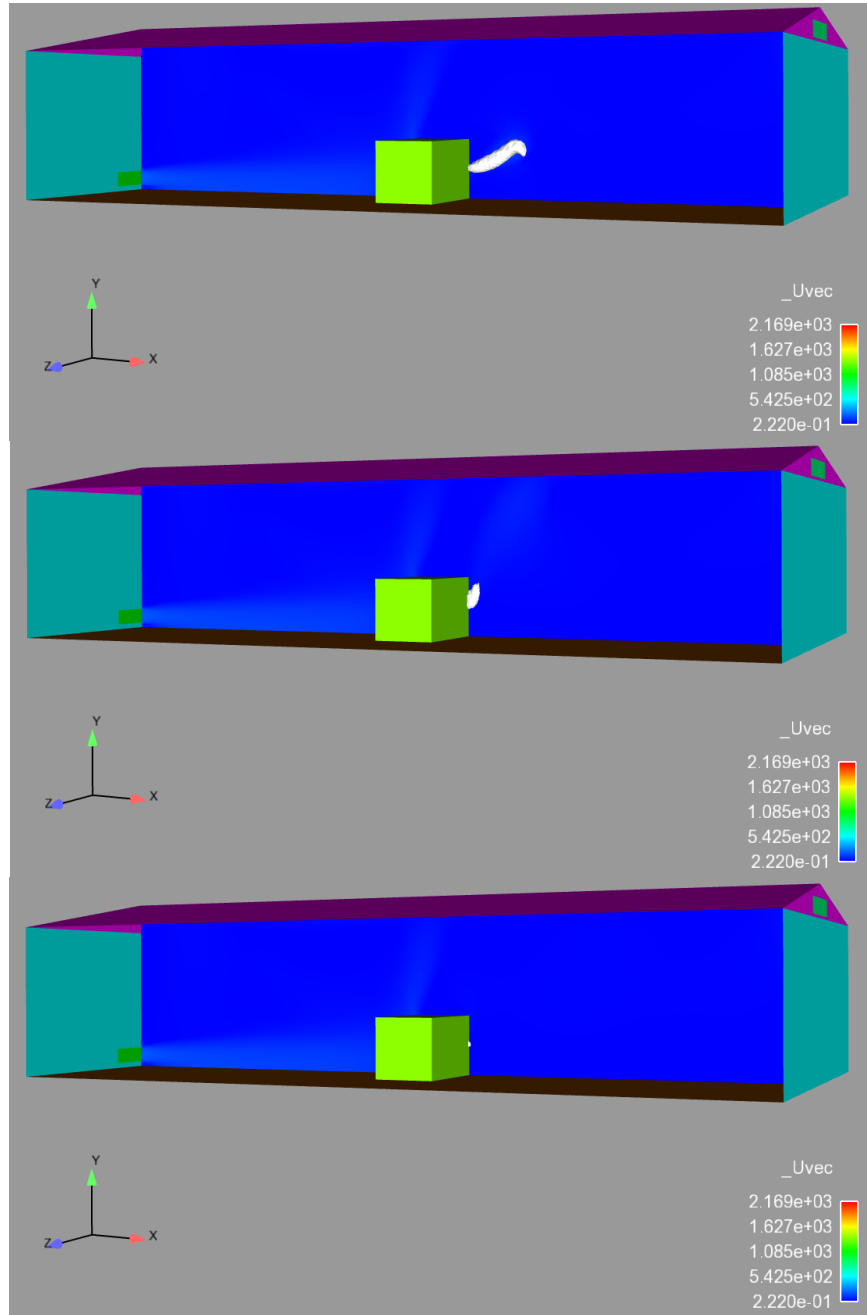

Figure 8: Maintenance facility natural gas LFL iso-contours at 2.5 (top), 10 (center), and 30.0 (bottom) seconds into the release for the layouts without roof supports for the CNG line cracking scenario.

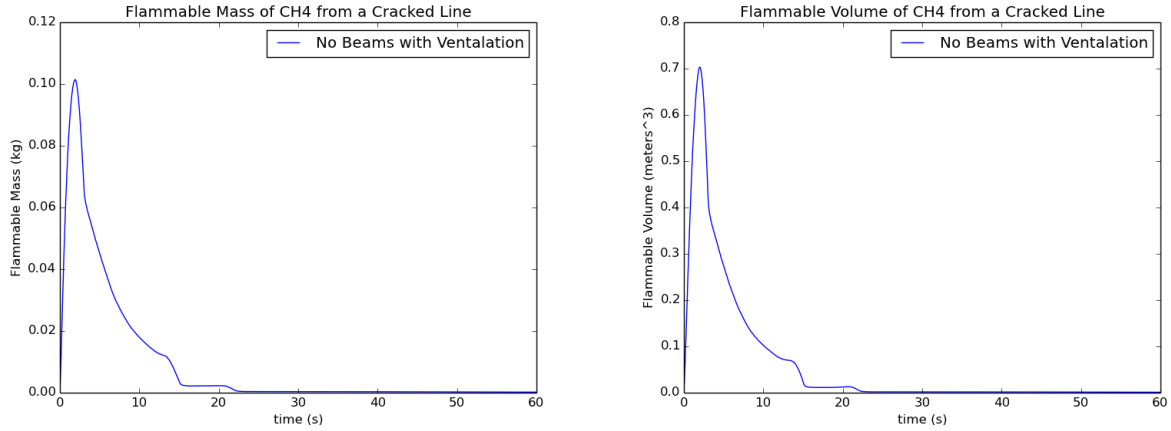

Figure 9: Time-histories of total natural gas flammable mass and volume for the CNG blow-down scenario.

#### 4.3.3. Full-Scale Tank Blow-Down due to a Mechanical Failure of the PRD

In the final scenario, the transient blow-down was modeled of a fully fueled CNG cylinder with a 700 liter volume and pressurized to 248 bar that released all contents due to the mechanical failure of a thermally activated PRD through a 6.2 mm diameter orifice. Once again the transient blow-down was modeled via NETFLOW, with the blow-down curve plotted in Figure 10. Note that higher flow rates and longer release durations meant these simulations were far more computationally expensive. Accordingly only a single configuration could be evaluated within the current project scope. To ensure the worst-case-scenario, the facility layout with roof supports and active mechanical ventilation was selected since vortical flow structures above the plume were thought to aid in the accumulation of flammable mixture near the release point (see Appendix B for further details). The fine mesh was used to ensure convergence of all conservation equations for the higher Reynolds number flow from the larger release.

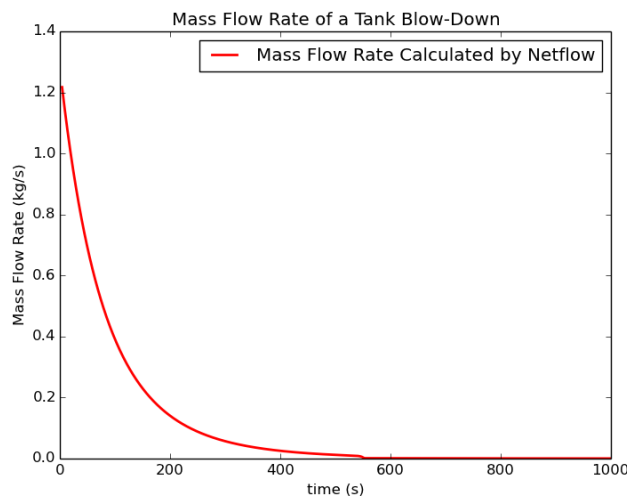

Figure 10: Mass flow rate time-history for the CNG tank blow-down scenario calculated from NETFLOW for a 700 liter tank pressurized with natural gas to 248 bar and released through an a 6.2 mm diameter orifice. Note that the tank volume was 50% greater than normal to simulate a worst case scenario.

Images of LFL iso-contours from the release plume at discrete times are provided Figure 11, along plots of the flammable mass and volume for each time selected. It should be noted that the rapid expansion forced temperatures within the tank to quickly drop, which likewise lowered the leak exit temperature. By 220 seconds into the release the temperatures at the leak exit plane had dropped below the condensation point (i.e., 160 K at ambient pressure), which was expected to result in two-phase flow behavior in the exit stream. Liquid parcel velocities develop at different rates relative to the vapor phase due to density differences. The difference in phase velocity, often referred to as the slip velocity, can significantly impact cryogenic releases dispersion results [31]. Velocity slip modeling is beyond the current simulation capabilities, which means dispersion data beyond 220 seconds into the release cannot be trusted. However, by this point 100.6 kg or about 87.6% of the original tank contents had been evacuated. Thus, it seems likely that flammable mass values within the enclosure had reached or were near their peak values by this time.



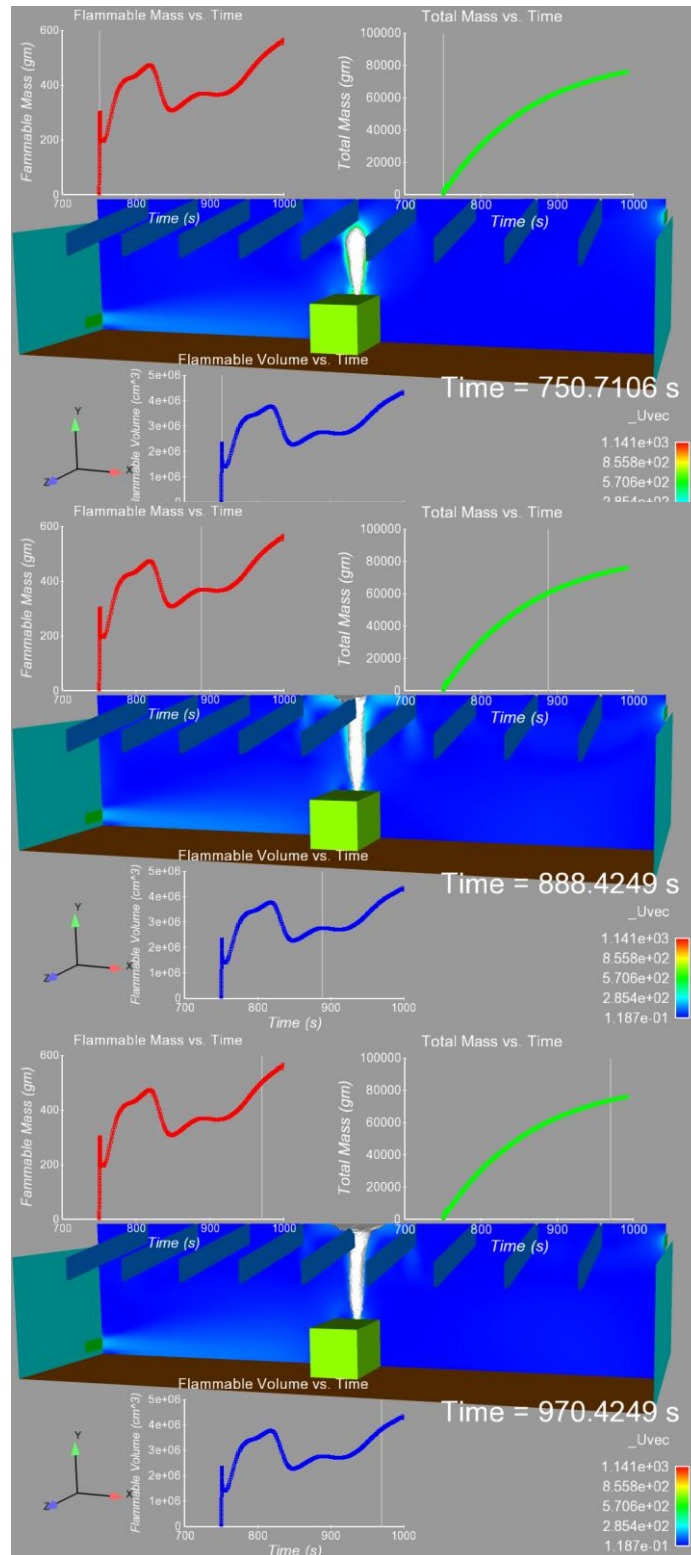

Figure 11: Maintenance facility natural gas LFL iso-contours for the CNG tank blow-down scenario from a 700 liter tank pressurized to 248 bar for the facility layout with active ventilation, roof support beams, and a vertical release into the enclosure. Time histories of flammable mass and volume are also included.

From Figure 11, it can be observed that the release plume rapidly reached the ceiling located 4.9 m above the vehicle release point, and retained flammable concentrations from the vehicle to the ceiling for the duration of the release. Two distinct peaks in both flammable mass and volume time histories were observed. The first occurred 68 seconds into the release as the flammable mixture steadily accumulated into the roof rafters and began to spread horizontally across the ceiling. The peak flammable mass at this point was 473 g, which for the present facility corresponded to a peak estimated overpressure of 2.1 kPa from equation 1. A second peak at 501 g, which corresponds to a peak estimated overpressure of 2.2 kPa, occurred 220 seconds into the release as the cooler release plume became denser with slower mixing rates within the release plume. As mentioned earlier, the simulation accuracy is questionable beyond this point in the release. Nonetheless, it appears that the flammable mass is steadily increasing and has not yet hit an asymptote. If as a worst case scenario, the flammable mass were to triple to around 1.5 kg—which seems extremely conservative given the small amount of natural gas remaining in the tank and the relatively low flow rates by this point—peak overpressures would increase to around 6.6 kPa. According to [30, 32], even this conservative overpressure estimate is still below the threshold needed for injuries due to projected missiles (6.9 kPa), eardrum rupture (13.8 kPa), or the collapse of unreinforced concrete walls (15 kPa). Note that most of the flammable volume exists in the plume, which itself is mostly located below the 0.46 m threshold for protection from electrical ignition sources stipulated in NFPA 30A. It is also important to note that the overpressure calculation should be linearly proportional to the facility volume. Hence, if the facility volume were to be halved, the expected overpressure from the volumetric expansion of hot gases would roughly double above the reported values, which could introduce potentially hazardous scenarios.

## 5. Summary and Conclusions

CVEF and SNL have partnered to analyze current regulatory issues regarding NGV maintenance facility operations. The goal has been to leverage their collective experience with code interpretation, hazard analysis, NGV fuel system design, and facility operations, along with well-developed modeling capabilities to inform code development for NGV facility construction and maintenance. While existing code language has been developed from user experience, it is recognized by SDOs that risk-informed approaches that identify high-risk scenarios along with dominant causal factors and that quantify the effectiveness of accident prevention/mitigation strategies are needed. The scope of work has been split into two phases with the current report summarizing the results from Phase I. Phase I work involved a detailed survey of existing regulations, a HAZOP to identify critical hazards from operational activities, and an analysis of potential consequences for credible hazards. These measures will be used as the basis for identifying best practices and codes and standards improvements. The HAZOP analysis included additional columns where prevention features, detection methods, and mitigation features information can be recorded. These fields were not completed for the Phase I work since these data can be different for the various Operation States applicable to each scenario. These scenarios will be split out individually as needed and populated as part of Phase II work. Phase II work is also expected to use the Phase I generated information to develop best practices, suggest hazard mitigation strategies, and recommend changes to existing fire protection codes.

For the hazard analysis work, detailed CFD simulations were performed at Sandia to examine the 3 release scenarios identified from the HAZOP: (1) a dormant LNG blow-off, (2) indoor CNG fuel system purge downstream of the storage isolation valves, and (3) a full-scale CNG tank blow-down due to a failure of the PRD. Methane was used as a proxy for natural gas in the simulations. The reference NGV facility had dimensions of 30.5 m long, 15.2 m wide and 6.1 m tall, with pitched roof. Geometries with and without evenly spaced roof rafters were examined. The impact of active ventilation at the commonly prescribed rate of 5 ACH versus a facility with passive ventilation was also considered for the dormant LNG blow-off scenario. For conditions with mechanical ventilation, air was forced into the enclosure 720 seconds before the start of the release to ensure internal steady flows. The vehicle was modeled as a cuboid and placed in the center of the NGV maintenance facility. Harm potential from peak overpressure was estimated using an model developed by FM Global for transient leaks and validated against previous Sandia data for hydrogen indoor refueling scenarios. For the overpressure model inputs, the time-history of the flammable mass and volume (i.e., natural gas/air mixture within the flammable bounds) was extracted from the CFD simulation results.

From velocity maps within the NGV maintenance facility, ventilation currents were observed to form recirculation regions when they interacted with the vehicle or roof rafters, which could distort the release plumes and generate flammable mixture accumulation regions. However, for the scenarios investigated, little sensitivity was observed for ventilation or roof supports due to the short durations of the releases relative to the ventilation rates and the propensity of the support structures to enhance mixing. Accordingly, for the low-flow release scenarios that involved a dormant LNG blow-off or a CNG fuel system purge, the flammable masses, volumes, and extents were low, and the flammable regions disappeared shortly after the conclusion of the

leaks. Moreover, predicted peak overpressures indicated there was no significant hazard expected.

For the larger release, low leak-exit temperatures late into the release resulted in natural gas state conditions that could not be modeled FUEGO simulation package, with results beyond this point were rejected, although over 85% of the cylinder contents had evacuated into the enclosure by this point. Nonetheless, the release plume quickly achieved a nearly steady flammable volume that extended from the release point at the vehicle up to the ceiling located 4.9 meters above the release, before spreading slightly across the ceiling. Two peaks were observed in the flammable mixture time-histories. The first peak occurred 68 seconds into the release where vessel flow rates were still relatively high and previously expelled mixture accumulated in flammable concentrations along the ceiling. The second peak occurred at the end of the accepted simulation results and was attributed to increasingly cool and dense exit plumes that had slower mixing rates. For both peaks, there was roughly 0.5 kg of natural gas predicted to exist in flammable regions, which for the facility examined could produce an overpressure of around 2.2 kPa—enough to break glass, but not much else. It was noted that flammable mass values would likely further increase beyond if the leak dispersion characteristics were properly modeled. However, even a conservative estimate for the expanded overpressure potential is still below the threshold required for significant harm. It should be cautioned that no attempt to calculate local blast-wave pressures was performed, which could result in additional overpressures above those described here. However, the relatively small volumes of the flammable regions mean that there is little opportunity for flame acceleration needed for blast-wave development.

For Phase II work, additional layout configurations should be evaluated with the tank blow-down scenario, since this is the only scenario capable of generating harmful overpressure effects. Furthermore, since the current simulations require several weeks to run, there is a need simplified tools development to enable parametric investigations of multiple facility configurations and leak conditions. Current work in this regard for the hydrogen safety programs could be leveraged for use with natural gas.

## References

- [1] LaChance J, Houf W, Middleton B, Fluer L, Analyses to Support Development of Risk-Informed Separation Distances for Hydrogen Codes and Standards. SAND 2009-0874, Sandia National Laboratories, March, 2009.
- [2] Rose SE, Flamberg S, Leverenz F, Guidance Document for Incorporating Risk Concepts into NFPA Codes and Standards. Fire Protection Research Foundation, March, 2007.
- [3] Groth KM, Mosleh A, A data-informed model of performance shaping factors and their interdependencies for use in human reliability analysis. Reliability, Risk and Safety: Theory and Applications Vols 1-3, 2010:231-8.
- [4] Houf WG, Evans GH, James SC, Merilo E, Groethe M, Simulation of Hydrogen Releases from Fuel-Cell Vehicles in Tunnels. Proc World Hydrogen Energy Conf, Essen, Germany, May 16-21, 2010.
- [5] Houf WG, Evans GH, Ekoto IW, Merilo EG, Groethe MA, Hydrogen fuel-cell forklift vehicle releases in enclosed spaces. Int J Hydrogen Energy, 2013;38:8179-89.
- [6] Horne DB, Guideline for Determining the Modifications Required for Adding Compressed Natural Gas and Liquefied Natural Gas Vehicles To Existing Maintenance Facilities. Clean Vehicle Education Foundation, <http://www.cleanvehicle.org/committee/technical/PDFs/GuidelinesDocumentFinal.pdf> August 31, 2012.
- [7] International Fire Code, International Code Council, Country Club Hills, IL, 2012.
- [8] International Mechanical Code, International Code Council, Country Club Hills, IL, 2012.
- [9] International Building Code, International Code Council, Country Club Hills, IL, 2012.
- [10] Code for Motor Fuel Dispensing Facilities and Repair Garages, National Fire Protection Association, NFPA 30A, Quincy, MA, 2012.
- [11] Vehicular Gaseous Fuel Systems Code, National Fire Protection Association, NFPA 52, Quincy, MA, 2010.
- [12] Standards for Parking Structures, National Fire Protection Association, NFPA 88A, Quincy, MA, 2007.
- [13] Horne DB, Safety Advice for Defueling CNG Vehicles and Decommissioning and Disposal of CNG Cylinders. Clean Vehicle Technology Foundation, <http://www.cleanvehicle.org/committee/technical/PDFs/CVEFDefuelDecomDisposeFinal.pdf>.

- [14] "Risk Assessment and Risk Management for the Chemical Process Industry." Edited by Greenberg HR, Cramer JJ, New York: Stone & Webster Engineering Corporation, Nostrand Reinhold, 1991.
- [15] Hazard and Operability Studies (HAZOP Studies) – Application Guide, British Standard IEC, 21882:2001, Aug 28, 2001.
- [16] Moen CD, Evans GH, Domino SP, Burns SP, A Multi-Mechanics Approach to Computational Heat Transfer. Proc ASME Int Mech Eng Cong and Exhibition, New Orleans, IMECE2002-33098, Nov. 17-22, 2002.
- [17] Minkowycz WJ, Sparrow EM, Schneider GE, Pletcher RH, "Elliptic systems: finite element method 1, handbook of numerical heat transfer." New York: J. Wiley and Sons, Inc., 1988.
- [18] Papageorgakis GC, Assanis DN, Comparison of linear and nonlinear RNG-based k-epsilon models for incompressible turbulent flows. Numer Heat Tr B-Fund, 1999;35:1-22.
- [19] Winters WS, A New Approach to Modeling Fluid/Gas Flows in Networks. SAND2001-8422, Sandia National Laboratories, July, 2001.
- [20] National Institute of Science and Technology. 2013. Available from: <http://webbook.nist.gov/chemistry/fluid/>.
- [21] Bauwens CR, Chaffee J, Dorofeev S, Effect of Ignition Location, Vent Size, and Obstacles on Vented Explosion Overpressures in Propane-Air Mixtures. Combust Sci Technol, 2010;182:1915-32.
- [22] LaChance J, Tchouvelev A, Engebo A, Development of uniform harm criteria for use in quantitative risk analysis of the hydrogen infrastructure. Int J Hydrogen Energy, 2011;36:59-66.
- [23] Bradley D, Mitcheson A, Venting of Gaseous Explosions in Spherical Vessels .1. Theory. Combust Flame, 1978;32:221-36.
- [24] Tamanini F, Dust explosion vent sizing - Current methods and future developments. J Phys Iv, 2002;12:31-44.
- [25] Baker QA, Tang MJ, Scheler EA, Silva GJ, Vapor cloud explosion analysis. Process Saf Prog, 1996;15:106-9.
- [26] van den Berg AC, Versloot NHA, The multi-energy critical separation distance. J Loss Prevent Proc, 2003;16:111-20.
- [27] Bauwens CR, Dorofeev S, CFD Modeling and Consequence Analysis of an Accidental Hydrogen Release in a Large Scale Facility. Proc International Conference on Hydrogen Safety 5, Brussels, Belgium, 2013.

- [28] Ekoto IW, Houf WG, Evans GH, Merilo EG, Groethe MA, Experimental investigation of hydrogen release and ignition from fuel cell powered forklifts in enclosed spaces. *Int J Hydrogen Energy*, 2012;37:17446-56.
- [29] Zabetakis MG, *Flammability Characteristics of Combustible Gases and Vapors*. Washington D.C.: Bulletin 627, U.S. Department of Interior, Bureau of Mines, 1965.
- [30] "Guidelines for Evaluating the Characteristics of Vapor Cloud Explosions, Flash Fires, and BLEVEs." Center for Chemical Process Safety, Wiley-AIChE, 1998.
- [31] Giannissi SG, Venetsanos AG, Markatos N, Willoughby DB, Royle M, Simulation of Hydrogen Dispersion Under Cryogenic Release Conditions. *Proc nternational Conference on Hydrogen Safety 5*, Brussels, Belgium, 2013.
- [32] Jeffries RM, Hunt SJ, Gould L, Derivation of fatality of probability function for occupant buildings subject to blast loads. *Health and Safety Executive*, 1997.





# Appendix A: HAZOP Data Sheets

## HAZOP Analysis: Indoor LNG and CNG Maintenance Activities in Major Repair Facilities

HAZOP Number	Component	Operation State	Hazard Scenario	Causes	Consequences	Prevention Features		Mitigation Features	
						Design	Administrative	Detection Method	Administrative
1	LNG-1 (Overpressure regulator)	3in, 4, 7, 8	Leakage from regulator body	Seal failure, mechanical defect, damage, etc.	Minor leakage of GNG				
2	LNG-1 (Overpressure regulator)	3in, 4, 7, 8	Inadequate regulation of gas flow	Regulator failure	Overpressure of downstream components and potential GNG release				
3	LNG-1 (Overpressure regulator)	3in, 4, 7, 8	Inprocess leakage	Mechanical defect, damage, etc.	Potential minor release of GNG				
4	LNG-2 (Fuel Shutoff Valve)	3in, 4, 5, 7	Valve fails to shut completely, or leaks	Failure of seals, spurious operation	Potential catastrophic release of GNG				
5	LNG-3 (Heat exchanger)	3in, 4, 5, 7	Leakage from heat exchanger	Leaks of LNG or GNG due to defective materials, corrosion, thermal fatigue, pressure rupture, etc.	Release of LNG or GNG				
6	LNG-4 (LNG tank)	3in, 4, 5, 7, 8	Overpressure of tank and failure of relief valve to open	Valve failure, insulation failure, excessive hold time	Rupture of tank and catastrophic release of LNG				
7	LNG-4 (LNG tank)	3in, 4, 5, 7, 8	Overpressure of tank and proper operation of relief valve	Excessive hold time, insulation failure	Minor release of GNG				
8	LNG-4 (LNG tank)	3in, 4, 5, 7, 8	Outlet or fitting on tank fails	Manufacturing defect or installation error	Potential catastrophic release of LNG				
9	LNG-4 (LNG tank)	3in, 4, 5, 7, 8	Leak of LNG into the interstitial space between inner and outer tanks	Internal corrosion of tank, fatigue failure	Insulation failure, warming, overpressurization of the outer tank and potential catastrophic release				

HAZOP Number	Component	Operation State	Hazard Scenario	Causes	Consequences	Prevention Features		Mitigation Features	
						Design	Administrative	Detection Method	Design
10	LNG-4 (LNG tank)	3in, 4, 5, 7, 8	Damage to outer tank resulting in compromising the insulative capacity	Mechanical damage, accident	Accelerated warming of the tank, overpressurization of the outer tank and potential catastrophic release				
11	LNG-4 (LNG tank)	3in, 4, 5, 7, 8	Damage to the outer tank due to leakage from the inner tank to the interstitial space	Embrittlement and cracking due to cryogenic properties of the material	Potential catastrophic release of LNG				
12	LNG-5 (Pressure relief Valve)	3in, 4, 5, 7, 8	Release of GNG through PRV	Failure of PRV to reclose after proper venting	Total volume of tank released				
13	CNG-1 (Cylinders)	3in, 4, 5, 7, 8	Overpressurization of Cylinder	External fire AND failure of PRD to operate	Potential catastrophic release of CNG				
14	CNG-2 (Cylinders)	3in, 4, 5, 7, 8	Overpressurization of Cylinder	External fire AND successful operation of PRD	Potential catastrophic release of CNG				
15	CNG-1 (Cylinders)	3in, 4, 5, 7, 8	Outlet or fitting on tank fails	Manufacturing defect or installation or maintenance error	Potential catastrophic release of CNG				
16	CNG-1 (Cylinders)	3in, 4, 5, 7, 8	CNG tank rupture	Mechanical damage, tool or equipment impingement	Potential catastrophic release of CNG				
17	CNG-1 (Cylinders)	3in, 4, 5, 7, 8	Leakage from the cylinder	Accident, vandalism, crack propagation, fatigue failure	Potential catastrophic release of CNG				
18	CNG-2 (Cylinder Solenoid Valve)	3in, 4, 5, 7, 8	Leakage of CNG through body of solenoid	Mechanical damage, material failure	Minor release of CNG				
19	CNG-3 (Pressure Relief Device)	3in, 4, 5, 7, 8	Failure of PRD to hold pressures below activation pressure	Mechanical defect, material defect, installation error, maintenance error	Potential catastrophic release of CNG	Use improved PRD design		Gas detection system	Improved PRD is more reliable Prioritize parking of dead vehicles outdoors

HAZOP Number	Component	Operation State	Hazard Scenario	Causes	Consequences	Prevention Features			Mitigation Features	
						Design	Administrative	Detection Method	Design	Administrative
20	CNG-3 (Pressure Relief Device)	3in, 4, 5, 7, 8	PRD leak of CNG	Mechanical defect, material defect, installation error, maintenance error	Minor release of CNG					
21	CNG-4 (Ball Valve)	3in, 4, 5, 7, 8	Valve leaks	Failure of valve seat, material defect	Potential catastrophic release of CNG					
22	CNG-4 (Ball Valve)	5, 7	Inprocess leak through valve	Failure of valve seat, human error, material defect	Potential release of CNG					
23	CNG-5 (Manifold)	3in, 4, 8	Leakage from manifold	Material defect, mechanical damage, installation error	Minor release of CNG					
24	CNG-6 (Pressure Transducer)	3in, 4, 8	Leakages from transducer	Material defect, mechanical damage, installation error	Minor release of CNG					
25	CNG-7 (Bleed Valve)	3in, 4, 8	Leakages of CNG through bleed valve	Failure of bleed valve to reset following purge of residual pressure	Potential release of CNG					
26	CNG-8 (Needle Valve)	3in, 4, 8	Leakage from needle valve	Failure of valve to reset properly, mechanical damage, material defect	Potential release of CNG					
27	CNG-9 (Defuel Port)	1	No credible scenario for indoor operation states							
28	CNG-10 (Fuel Port Filter)	8	Leakage from filter housing or fitting	Installation error, material damage	Potential release of CNG					
29	CNG-11 (Fill Manifold)	8	Leakage from manifold	Material defect, mechanical damage, installation error	Minor release of CNG					
30	CNG-12 and CNG-13 (Fill Receptacles)	8	Leakage from receptacles during refueling	Misalignment of nozzle, mechanical damaged seal on fill port	Potential release of CNG					
31	CNG-14 and CNG-15 (Pressure Gauges)	3in, 4, 8	Leakage from gauges or fittings	Installation error, material damage	Potential release of CNG					
32	CNG-15 (Inline Fuel Filter)	3in, 4, 8	Leakage from filter housing or fitting	Installation error, material damage	Potential release of CNG					

HAZOP Number	Component	Operation State	Hazard Scenario	Causes	Consequences	Prevention Features			Mitigation Features	
						Design	Administrative	Detection Method	Design	Administrative
33	CNG-17 (Fuel Line Solenoid Valve)	3in, 4, 8	Leakage of CNG through body of solenoid	Mechanical damage, material failure	Minor release of CNG					
34	CNG-18 (Regulator)	4, 8	Overpressurization of engine fuel line	Failure of regulator to properly restrict downstream pressure to the engine	Potential damage to downstream piping or component, leading to release of CNG					
35	CNG-20 (Tubing)	3in, 4, 5, 7, 8	Leakage from tubing	Mechanical damage, material failure, installation error	Potential release of CNG					
36	Multiple	3in, 4, 5, 7, 8	Release of NG from any fuel component after re-opening of the ball valve	Mechanical damage to fuel system lines during other system maintenance, improper installation or re-assembly	Potential for release of total volume of gas					
37	Multiple	Multiple	Release of LNG or CNG component when removed	Procedures violated (Gas train not emptied, tank not isolated)	Total volume of system released		Procedure to perform run down prior to service		Gas indicator alarm	Personnel training
38	Multiple	6	Release of NG from any component when removed	Failure of personnel to properly defuel or vent gas	Release of total volume of tank					
39	Multiple	6	Release of NG from any component when removed	Failure of system to vent completely due to blockage or constriction due to debris or contaminants in the system	Release of a portion of the tank contents					
40	Multiple	6	Release of NG from any component when removed	Faulty signal from electronic control unit or sending unit indicates inaccurate fuel level	Release of total volume of tank					
41	Multiple	6	Release of NG from any component when removed	Faulty signal from high or low pressure gauge falsely indicates system has been vented	Release of total volume of tank					

## Appendix B: Supplemental CFD Simulation Data

In this Appendix, supplemental CFD simulation data that could not easily fit into the body of the text is included. For the LNG blow-off scenario, concentration maps are provided in Figure 12 and Figure 13 for the conditions with and without roof supports respectively. From these images, it can be observed that ventilation induced low pressure regions led to substantial distortion of the release plume near the release where flammable concentrations were highest. For the scenario without roof supports, the plume impinged on the ceiling and formed a wall jet that spread along the ceiling. The spread direction was biased towards the exit vent due to the room currents from the ventilation system.

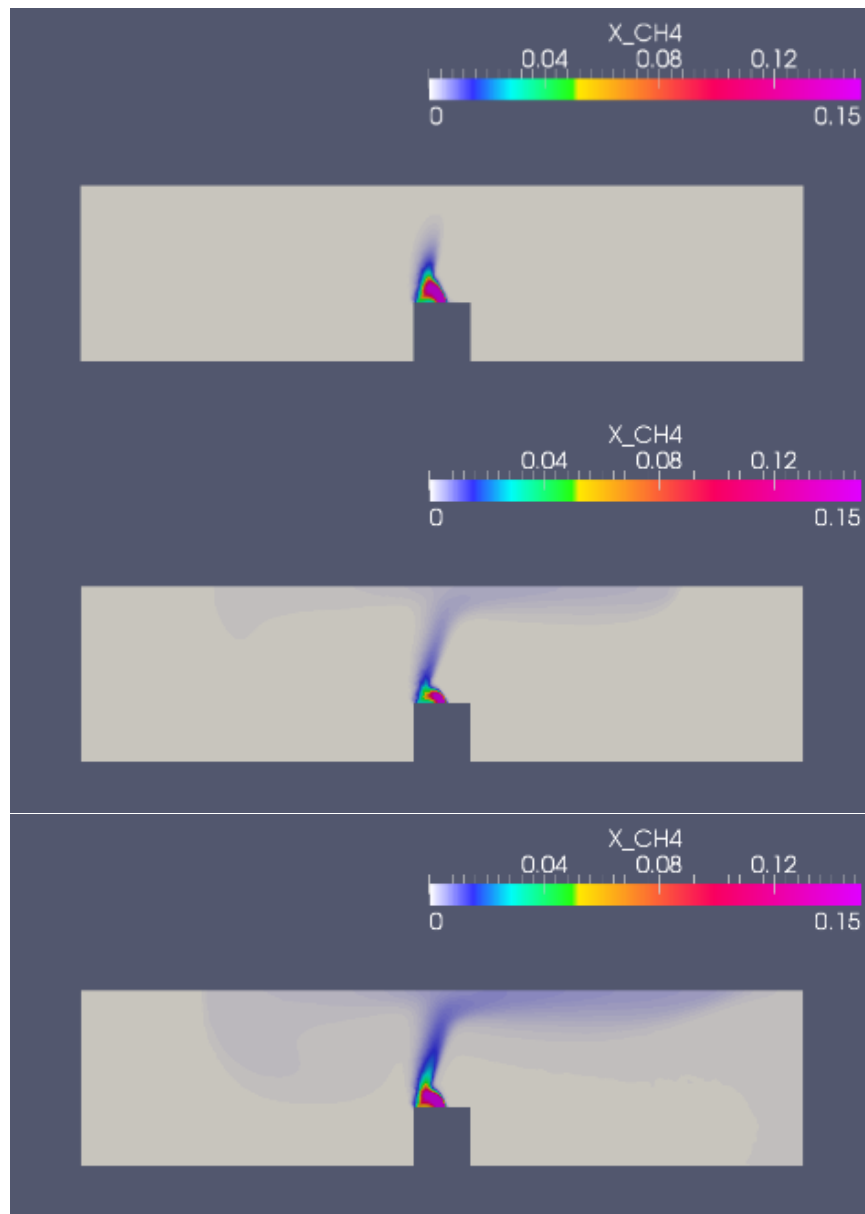

Figure 12: NGV Maintenance facility natural gas mole fraction contours at 10, 60, and 306 seconds into the release for the facility layouts without roof supports for the LNG blow-off scenario.

For the facility layout that included roof supports, recirculation vortices formed by the interaction between the room currents and the beams resulted in a localized accumulation region of lean natural gas near the release plume. Over time, the concentration of plume became richer as very little natural gas was able to escape through the exit vent. However, as was seen in Figure 5, the impact on flammable concentrations within the enclosure was negligible since the accumulation rates were slow relative the release duration. It was thought that the accumulation region could have a bigger impact for longer duration releases, which is why this facility configuration was selected for the CNG tank blow-down scenario.

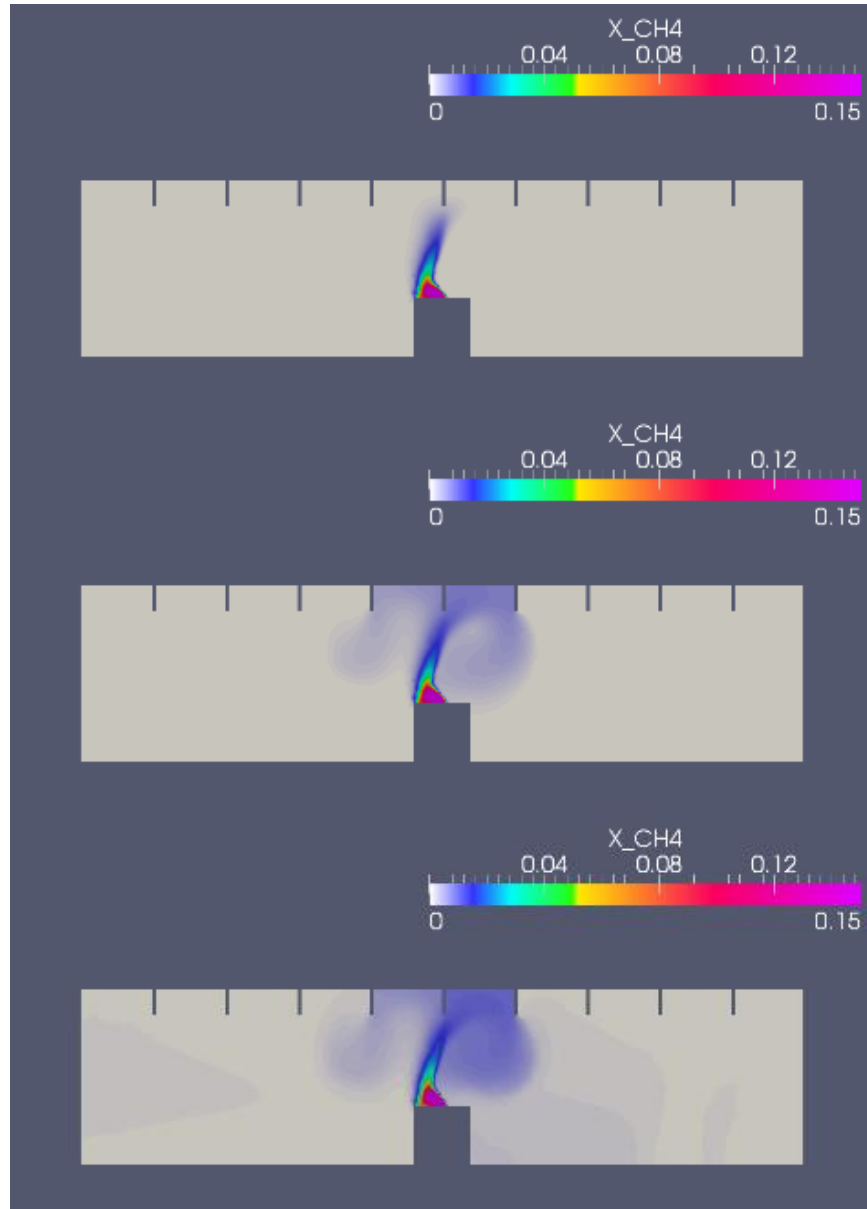

Figure 13: NGV Maintenance facility natural gas mole fraction contours at 10, 60, and 306 seconds into the release for the facility layouts with roof supports for the LNG blow-off scenario.

Natural gas concentration maps from the maintenance facility center plane at 2.5 and 30.5 seconds into the release for the NGV facility configuration without support beams are provided in Figure 14. Despite flammable concentrations initially concentrated near the release, the rapid decay in mass flow rates coupled with strong diffusion that quickly mixed the plume with ambient air led to very short durations for flammable mixtures in the facility.

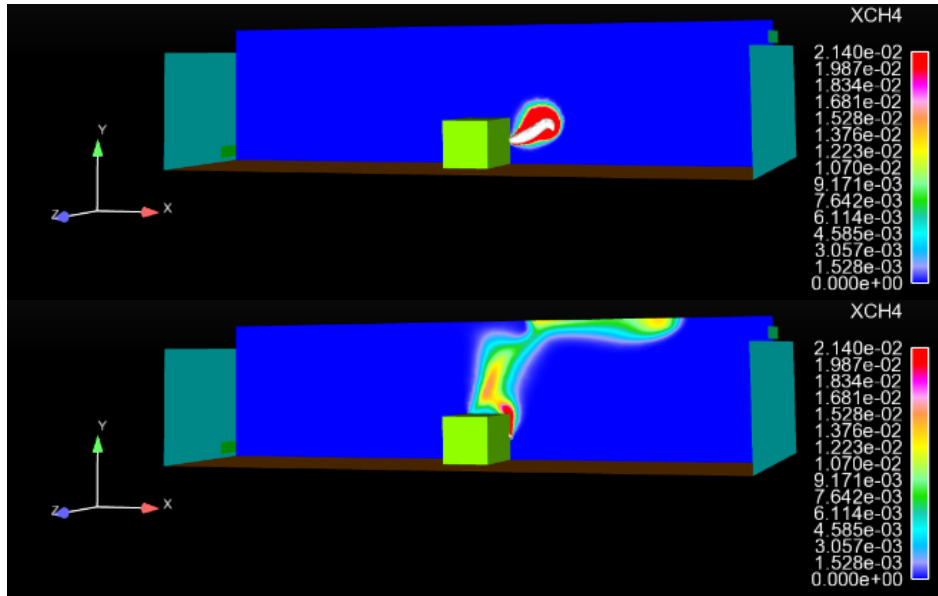

Figure 14: Maintenance facility natural gas mole fraction contours at 2.5 (top) and 30.5 (bottom) seconds into the release for the layouts without roof supports for the CNG line cracking scenario.





## Distribution

1. Douglas B. Horne  
DBHORNE LLC  
Clean Vehicle Education Foundation  
6011 Fords Lake Ct.  
Acworth, GA 30101
2. MS0748            A. Christine LaFleur            6231
3. MS0748            Jeffery L. LaChance            6231
4. MS9052            Isaac W. Ekoto            8367
5. MS9052            Daniel E. Dedrick            8367
6. MS9054            Robert Q. Hwang            8300
7. MS9054            Arthur E. Pontau            8360
8. MS9957            Myra L. Blaylock            8365
9. MS0899            Technical Library            9536 (electronic copy)
10. MS0115            OFA/NFE Agreements            10012

