

SANDIA REPORT

SAND2016-9719

Unlimited Release

Printed September 2016

Feasibility of the SF-BREEZE: a Zero-Emission, Hydrogen Fuel Cell, High-Speed Passenger Ferry

Joseph W. Pratt and Leonard E. Klebanoff

Prepared by
Sandia National Laboratories
Albuquerque, New Mexico 87185 and Livermore, California 94550

Sandia National Laboratories is a multi-program laboratory managed and operated by Sandia Corporation, a wholly owned subsidiary of Lockheed Martin Corporation, for the U.S. Department of Energy's National Nuclear Security Administration under contract DE-AC04-94AL85000.

Approved for public release; further dissemination unlimited.



Sandia National Laboratories

Issued by Sandia National Laboratories, operated for the United States Department of Energy by Sandia Corporation.

NOTICE: This report was prepared as an account of work sponsored by an agency of the United States Government. Neither the United States Government, nor any agency thereof, nor any of their employees, nor any of their contractors, subcontractors, or their employees, make any warranty, express or implied, or assume any legal liability or responsibility for the accuracy, completeness, or usefulness of any information, apparatus, product, or process disclosed, or represent that its use would not infringe privately owned rights. Reference herein to any specific commercial product, process, or service by trade name, trademark, manufacturer, or otherwise, does not necessarily constitute or imply its endorsement, recommendation, or favoring by the United States Government, any agency thereof, or any of their contractors or subcontractors. The views and opinions expressed herein do not necessarily state or reflect those of the United States Government, any agency thereof, or any of their contractors.

Printed in the United States of America. This report has been reproduced directly from the best available copy.

Available to DOE and DOE contractors from
U.S. Department of Energy
Office of Scientific and Technical Information
P.O. Box 62
Oak Ridge, TN 37831

Telephone: (865) 576-8401
Facsimile: (865) 576-5728
E-Mail: reports@osti.gov
Online ordering: <http://www.osti.gov/scitech>

Available to the public from
U.S. Department of Commerce
National Technical Information Service
5301 Shawnee Rd
Alexandria, VA 22312

Telephone: (800) 553-6847
Facsimile: (703) 605-6900
E-Mail: orders@ntis.gov
Online order: <http://www.ntis.gov/search>



Feasibility of the SF-BREEZE: a Zero-Emission, Hydrogen Fuel Cell, High-Speed Passenger Ferry

Joseph W. Pratt¹ and Lennie E. Klebanoff²

¹Energy Innovation (8366)

²Hydrogen and Combustion Technology (8367)

Sandia National Laboratories

P.O. Box 969

Livermore, California, 94551

Abstract

The SF-BREEZE project examined the technical, regulatory, and economic feasibility of a high-speed passenger ferry powered solely by hydrogen fuel cells and its associated hydrogen fueling infrastructure within the context of the San Francisco Bay.

In conjunction with a naval architect, a realistic, feasible vessel design meeting all performance specifications was produced. Collaboration with and evaluation by both the US Coast Guard and the American Bureau of Shipping did not reveal any insurmountable regulatory obstacles to deployment.

The supply of liquid hydrogen to the vessel was examined and viable sites were found at both ports studied. Industrial gas companies were consulted and provided technically viable fueling facility designs.

The current design of the zero emission ferry has a cost premium compared to a conventional diesel ferry. Cost reduction strategies specific to the vessel and leveraging those expected in the fuel cell electric vehicle market may result in future cost parity.

Acknowledgements

The authors wish to thank Sujit Ghosh at the US DOT/Maritime Administration's Office of Environment for skillfully managing this project and his continued support, involvement, enthusiasm, insight, and numerous technical contributions. Also at MARAD we would like to thank Michael Carter, Director, Office of Environment; John Quinn, Associate Administrator for Environment, Safety & Vessel Security; and Paul "Chip" Jaenichen, MARAD Administrator, for their ongoing support and personal interest not only in this project but also in the wider goal of improving the environmental impact of maritime activities.

This project concept was conceived by Thomas C. Escher, President of the Red and White Fleet. Tom believes that reducing vessel emissions to ZERO is imperative if the maritime industry is to make meaningful reductions in climate change and airborne pollutants. Tom's passion has been a constant motivating factor in ensuring the entire project team produces a timely, high quality, and accurate assessment.

The authors greatly appreciate the generosity of all of those consulted through the course of this study, who without exception shared their time and information with enthusiasm and thoughtfulness. It has been enlightening and humbling to see the breadth of support and engagement for this concept through many sectors of the public and private sector and across the country. This study could not have been successful without the substantial contributions from all those listed.

- Red and White Fleet: Tom Escher, Captain Joe Burgard
- Elliott Bay Design Group: Curt Leffers, Kelly Sonerholm, Taylor Herinckx, Eileen Tausch, John Waterhouse, Russ McComb
- Lighthouse Public Affairs: Boe Hayward
- US Coast Guard – Design and Engineering Standards: Thane Gilman, Tim Meyers, LT PJ Folino
- US Coast Guard – Marine Safety Center: LT Kate Woods, LT Margaret Woodbridge, CDR Sean Brady
- US Coast Guard – Sector San Francisco: CAPT Gregory Stump, CAPT Patrick Nelson, CDR Nicole Vaughan, CDR Jennifer Stockwell, LCDR Mark Labert, LT Mike Wu, Hannah Reeves, MSTC Rob Lesko
- US Coast Guard – Liquid Gas Carrier National Center of Expertise: CDR Jason Smith, CDR Dallas Smith
- American Bureau of Shipping: Roy Bleiberg, Emil Shtaygrud, Steve O'Day, Roshan Jacob, Suresh Pisini, Rich Delpizzo, Kevin Storm, Prasad Mantravadi, Todd Stallings, Altaf Shaik, Jihed Boulares, Yakov Timashpolskiy
- Port of San Francisco: Rich Berman, Monique Moyer, Elaine Forbes, Jay Ach, Mark Lozovoy, John Davey, Eunejune Kim, Uday Prasad, Ken Cofflin, Tom Carter, Aaron Golbus, Kimberly Beal
- Sandia National Laboratories: Chris LaFleur, MIDN David Kramer (intern from US Naval Academy), Stephanie Beasley, Patti Koning, Samantha Lawrence, Paul Gibbs, Chris San Marchi, Pat Sullivan, Tom Felter, Art Pontau (retired), Bob Hwang
- Hydrogenics: Ryan Sookhoo

- Air Products: Brian O’Neil, Dave Farese, Brian Bonner, Ed Kiczek
- Praxair: Lauren Moser, Mark Wattanapanom, Roger Han, Rick Craighead
- Linde: Kyle McKeown, Nitin Natesan, Mike Beckman, John Smith
- Air Liquide: Ole Hoefelmann, Bob Oesterreich, Aaron Harris
- NASA Kennedy Space Center Cryogenics Test Laboratory: James Fesmire, Bruce Chesson, Bill Notordonato, Adam Swanger, Kevin Jumper
- San Francisco International Airport (SFO): Derek Fleiss and Dave Charney
- UC Berkeley: Tim Lipman
- Bay Area Air Quality Management District: Anthony Fournier, Joe Steinberger
- Port of Redwood City: Mike Giari, Chris Fajkos
- City of Redwood City: Gary Lepori, Dennis Lockard
- City and County of San Francisco Department of Environment: Debbie Raphael, Suzanne Loosen
- California Lieutenant Governor Gavin Newsom
- San Francisco Office of Mayor Edwin M. Lee: Andrew Dayton
- California Fuel Cell Partnership: Nico Boukamp, Bill Elrick
- Bay Area Council: Jim Wunderman, Emily Loper, John Grubb
- California Energy Commission: Jim McKinney, Rhett deMesa
- California Air Resources Board: Andrew Martinez, Gerhard Achtlek, Catherine Dunwoody, Jennifer Lee, Kirk Rosenkranz, John Lee.
- California Governor’s Office of Business and Economic Development (GO-Biz): Tyson Eckerle, Taylor Jones
- Office of California Governor Edmund G. Brown Jr.: Wade Crowfoot
- WETA: Marty Robbins
- Scripps Institution of Oceanography: Bruce Appelgate, Zoltan Kelety
- ITM Power: Steve Jones, Geoff Budd
- Foss Maritime: Susan Hayman, Jason Bone
- Passenger Vessel Association: Karen Rainbolt, Eric Christensen
- DNV-GL: Anthony Teo, Gerd Petra Haugom, Afshin Mombeinipour
- Institute for Energy Technology (Norway): Martin Kirkengen
- Research Center Julich: Karl Verfondern
- Zero Carbon Energy Solutions: Jay Keller
- Gardner Cryogenics: Jim Mullen
- Worthington Industries: Keith Carrabine
- American Lung Association: Will Barrett
- Center for Technology and Environment: Jamie Leven
- US Department of Energy: Pete Devlin, Greg Moreland
- SCI: John Coursen
- Matheson Tri-Gas: Andrew Slauch
- Lincoln Composites: Dale Tiller
- Doosan: Tim Patterson

Executive Summary

In September 2014, Thomas C. Escher of the Red and White Fleet, a tour boat company founded in 1892 in San Francisco, CA, approached Sandia National Laboratories with a request. Mr. Escher had heard from the US Department of Energy how hydrogen fuel cells can produce power with zero emissions and wondered if such technology could be applied to a new vessel. "Everyone is talking about reducing emissions by 20 percent, 40 percent or more," he said. "Why not do away with emissions altogether?"

Others have also realized that incremental reductions in equipment emissions will not be successful in reducing overall emissions due to the constant growth and industrialization of the world. Unless we have a new transportation technology with emissions reductions approaching 80% or more, the emission reductions will not be robust against growth in either population, or growth in the intensity with which technology uses energy.¹ Such deep cuts are consistent with recommendations from the Intergovernmental Panel on Climate Change (IPCC)² and U.S National Academy of Sciences studies³. In the maritime industry they also match the conclusions of the International Maritime Organization which states⁴:

The emissions projections show that improvements in efficiency are important in mitigating emissions growth but even the most significant improvements modelled do not result in a downward trend. Compared to regulatory or market-driven improvements in efficiency, changes in the fuel mix have a limited impact on GHG emissions, assuming that fossil fuels remain dominant.

Hydrogen enables a zero-GHG energy pathway. As reviewed by Klebanoff et al.⁵, high efficiency hydrogen energy conversion devices that convert hydrogen into electrical or shaft power are powerful drivers for hydrogen technology. These conversion devices include hydrogen internal combustion engines (ICEs), both spark ignition and turbine hydrogen engines, along with hydrogen fuel cells.

The question then became: is it possible to build a commercially-useful, zero emission vessel powered by hydrogen? Others have demonstrated smaller and slower vessels used for tours in lakes and rivers.^{6,7} But vessels on the San Francisco Bay are workhorses, shuttling hundreds of commuters 20 nautical miles

¹ J. Keller, L. Klebanoff, S. Schoenung, and M. Gillie, "The Need for Hydrogen-based Energy Technologies in the 21st Century," in Hydrogen Storage Technology, Materials and Applications, L. E. Klebanoff, Ed., ed Boca Raton: Taylor & Francis, 2012, p. 3.

² S. Solomon, D. Qin, M. Manning, Z. Chen, M. Marquis, K. B. Averyt, M. Tignor, and H. L. Miller, "Climate Change 2007: The Physical Science Basis. Contribution of Working Group I to the Fourth Assessment Report of the IPCC," Intergovernmental Panel on Climate Change (IPCC), Cambridge, U.K.

³ National Research Council of the National Academies, America's Climate Choices, Panel on Advancing the Science of Climate Change, 2010.

⁴ "Third IMO GHG Study 2014: Executive Summary and Final Report, June 2014," International Maritime Organization, Marine Environment Protection Committee MEPC 67/INF.32014.

⁵ L. E. Klebanoff, Ed., Hydrogen Storage Technology, Materials and Applications. Boca Raton: Taylor & Francis, 2012.

⁶ "Clean Machines - GL," Germanischer Lloyd SE. Available: <http://www.gl-group.com/en/13111.php>, Accessed May 24, 2016.

⁷ C. Hornby, "First fuel cell boat cruises Amsterdam's canals," Reuters, 2009. Available: <http://www.reuters.com/article/us-dutch-fuelcell-idUSTRE5B83HD20091209>, Accessed May 24, 2016.

(nm) or more at a time, and have thousands of horsepower giving them the speed to compete with buses, cars, and other modes of transportation during morning and afternoon rush hours. A 5-8 knot, <100 passenger, 100-150 hp boat meant for calm seas would not be viable in the SF Bay commuting environment.

The specifications were drawn up: A 150 passenger, commuter ferry that had to travel four 50 nm round-trip routes each day, ~60% of the operational time travelling at a top speed of 35 knots. The concession compared to existing ferry service was an additional fueling stop allowed in midday, between the morning and evening commute times. The conceptual ferry was named the “SF-BREEZE” for San Francisco Bay Renewable Energy Electric vessel with Zero Emissions.

The project team assembled. The US Department of Transportation’s Maritime Administration would provide support. Sandia National Laboratories would be the independent technical evaluator, given its decades of experience in hydrogen technology. Red and White Fleet would provide operational requirements and evaluation. Elliott Bay Design Group (EBDG) would bring their expertise with diesel electric hybrid and liquefied natural gas (LNG) vessels to engineer a realistic ferry design. The US Coast Guard (USCG) and American Bureau of Shipping (ABS) were included from Day 1 to verify that the conceptual design would be compliant with applicable regulations and rules and if not, to identify areas requiring modification or refinement. As the project progressed, additional stakeholders were brought on board. The Ports of San Francisco and Redwood City were involved to provide insight on realistic bunkering facilities. Company experts from fuel cell companies, hydrogen suppliers, and specialized equipment vendors were consulted to provide the data needed to evaluate the suitability of the technologies for the SF-BREEZE. Federal, state, and local government agencies were consulted to determine local acceptance and potentially available financial assistance. Eventually other operators became involved as they realized the potential benefits of zero emission hydrogen vessels and an independent Working Group with dozens of stakeholders was formed to accommodate the interest and form a cohesive path forward of this larger picture.

The project team set the goal: *Determine the technical, regulatory, and economic feasibility of a high-speed passenger ferry powered solely by hydrogen fuel cells and its associated hydrogen fueling infrastructure within the context of San Francisco Bay, California, USA.*

Two branches of the project were formed. One task focused on technical and regulatory feasibility of the high-speed ferry, the other on the feasibility of the required land-side refueling infrastructure. Economic assessment would connect both of them.

To have enough information to attempt design of the vessel, EBDG needed to know the specifications of the powerplant and fuel storage. Through examination of the options, the project team selected proton exchange membrane (PEM) fuel cells for the powerplant due to their low weight and volume, commercial availability, proven track record, zero emission characteristic, and acceptable power performance. The fuel cell base model chosen for this case study was the Hydrogenics HyPM HD30 and detailed specifications and performance characteristics were provided by the manufacturer. It was then

determined that on-board storage of fuel had to be liquid hydrogen (LH₂) in order to minimize the weight that is so critical for performance of a high-speed vessel.

With these specifications of the major powerplant components, EBDG performed a Hull Comparison Study to determine a recommended hull configuration, settling on a catamaran rather than a monohull or trimaran. In fact this decision had more to do with the 35 knot speed requirements of the ferry rather than the hydrogen fuel cell powerplant, but it has the resulting advantage that a catamaran is more stable than a monohull, allowing placement of the LH₂ tank on the top of the vessel while still maintaining the required stability.

Meanwhile, the USCG and ABS were learning, through the efforts of the project team, that the properties of LH₂ were similar to those of LNG. There are some critical differences, such as the very high buoyancy of LH₂ and the ability of LH₂ to condense the components of air (N₂, O₂), but the two fuels have enough in common that it was determined that the IGF Code⁸ would be an appropriate regulatory starting point. It was thus decided that the SF-BREEZE would be built and regulated in accordance with 46 CFR Subchapter T – Small Passenger Vessels, which applies to vessels with 150 passengers or less and less than 100 ton gross weight, but the IGF Code will form the basis for the hydrogen and fuel cell features which are not included in the Subchapter T regulation. ABS Rules for High Speed Craft were also adopted along with a dozen other regulations, standards, and guidance documents to fill in the gaps in the existing marine regulations.

Armed with the specifications, equipment information, and regulatory basis, EBDG designed the SF-BREEZE. Figure ES-1 shows a 3-D engineering drawing of the final design, which meets the performance requirements. Included in the Appendix of this report is the design package describing the



Figure ES-1: 3-D engineering drawing of the SF-BREEZE.

⁸ 2015 International Code of Safety for Ships using Gases or other Low-flashpoint Fuels (IMO MSC 95/22/Add.1 (Adopted IGF Code))

determination of the features and layout considering weight distribution and hazardous zone requirements, performance characteristics, overall weight, power requirements, bunkering procedures, preliminary risk assessment, and a parametric cost estimate. The final specifications for the SF-BREEZE:

- Passenger capacity: 150 (the maximum allowed by Subchapter T regulations)
- Top Speed: 35 knots
- Total installed power: 4.92 MW (4.4 MW for propulsion at top speed, 120 kW for auxiliary power, and the remainder for margin) consisting of (41) 120 kW PEM fuel cell racks, each rack containing four 30 kW PEM fuel cell stacks.
- Fuel: 1,200 kg (~4,500 gallons) of LH₂ contained in a single Type C (pressurized vessel) storage tank on the top deck, enough for two 50 nm round trips before refueling, with 200-400 kg margin.
- Electrical architecture: DC power from the fuel cells converted to AC power for the motors. Either one or two motors per shaft.
- Propulsors: Waterjet or Voith linear jet
- Amenities: Standard passenger cabin with restroom and snack bar
- Zero greenhouse gas and criteria pollutants during operation

Due to the difference in characteristics between diesel engines and PEM fuel cells, EBDG estimated the SF-BREEZE would have the following benefits in addition to its elimination of emissions:

- Superior response time during power changes (such as during maneuvering)
- Less noise and vibration on-board
- Elimination of diesel fuel spills, diesel odor, and exhaust odor

With the vessel design in hand, the project team investigated the SF-BREEZE GHG emissions associated with five LH₂ fuel production pathways including renewable and non-renewable (fossil-fuel based) methods. Estimates are also made for GHG emissions associated with fossil-diesel production, as well as for biodiesel production, which can be considered a renewable “drop-in” fuel replacement for conventional diesel fuel. While hydrogen PEM fuel cell technology has zero emissions at the point of use, it is important to consider the fuel production pathway and delivery emissions in a “well-to-waves” (WTW) analysis. It was found that the WTW GHG emissions for the SF-BREEZE using non-renewable LH₂ are significantly higher than for the diesel-fueled *Vallejo* ferry on a per passenger basis. Due to the higher weight of the SF-BREEZE compared to the comparable diesel ferry, the SF-BREEZE has more on-board power in order to make 35 knots. This higher power makes the ferry consume more hydrogen, and when combined with the fact that making LH₂ is much more energy intensive than making diesel fuel. However, using renewable LH₂, WTW GHG emissions for the SF-BREEZE ferry are reduced 75.8% compared to the diesel-fueled *Vallejo*.

The team also compared the emissions of the criteria pollutants NO_x, hydrocarbons (HC), and particulate matter (PM) for the SF-BREEZE to that of the *Vallejo* held to Tier 4 emissions standards fueled by diesel fuel or biodiesel again using a full well-to-waves analysis. Compared to *Vallejo* Tier 4 emissions using diesel fuel, the SF-BREEZE using LH₂ derived from steam reforming of fossil natural gas reduces WTW

emissions of NO_x by 51.3%, HC by 68.8%, but PM emissions increase a factor of 2.5 times. Using LH₂ made from 100% renewable electricity, there would be a WTW 99.1% reduction in NO_x, a 99.2% reduction in HC, and a 98.6% reduction in PM compared to the *Vallejo* running on diesel fuel with Tier 4 emission constraints.

The final design package was submitted to both USCG and ABS for regulatory review and approval of the design basis and concept. ABS issued a conditional Approval in Principle (AIP) of the design, the conditions of which EBDG has evaluated, finding no obstacles to technical or regulatory feasibility. The USCG has declined our request to formally review the design. However, they have indicated agreement with the approach of using the IGF Code, along with research and analysis developed during this study, to inform a future risk-based equivalency request when the project moves beyond the feasibility study stage. Furthermore, early and frequent interactions with staff from the four USCG offices involved in the project gives confidence that a suitable regulatory design basis will be developed based on the standards proposed in this study.

Simultaneous with the SF-BREEZE vessel design, an assessment of the fueling infrastructure was underway. Required performance of the bunkering facility was determined in conjunction with EBDG as the vessel's fueling system was designed. The four major industrial gas companies (IGCs), Air Products and Chemicals, Linde, Praxair, and Air Liquide were consulted on various parts of the layout and design of the facility and LH₂ supply logistics. While the vessel specification allowed for one midday refueling, it came with the caveat that the vessel could be at the dock no longer than one hour for that refueling. While shorter than typical LH₂ transfer times on land, IGCs determined that this could be readily accomplished in a safe manner with the proper design of the system. Two types of bunkering operations were explored with the IGCs: bunkering from an on-site storage tank, and bunkering directly from an LH₂ delivery trailer. Different IGCs preferred different options but both were determined to be technically viable, with the direct trailer approach having less capital cost and more flexibility.

At the same time, the project team was hosted by the Port of San Francisco and the Port of Redwood City to examine actual potential bunkering locations. Both Ports were very encouraging of the SF-BREEZE technology. A study of the piers and wharves at the two Ports revealed several viable bunkering locations, two of which (one at each port) are currently available and could host such a facility today.

Existing maritime regulatory guidance around LH₂ bunkering is non-existent. Even the regulations around LNG fuel bunkering are not as developed as they are for LNG cargo transferring or the regulations governing use of LNG on the ship (the IGF Code). Despite this, the guidance from the class societies (ABS and DNV-GL in particular) along with the issued policy letters from the USCG provide enough of a basis to determine that the proposed bunkering arrangements discussed with the IGCs will be feasible from a regulatory perspective.

With no technical or regulatory obstacles identified, and the SF-BREEZE offering the desired deep reductions in total pathway (well to waves) GHG and criteria emissions, the project team turned to the economic assessment. The capital and operating costs of the ferry and bunkering facility were examined, as well as that of the LH₂ fuel. This was done with a comparison to an existing comparable

diesel ferry. As mentioned above, the SF-BREEZE carries more weight than a comparable diesel and thus has more installed power. In addition, PEM fuel cells today are currently considerably more expensive on a per-kW basis than diesel engines. Considering these two factors, the SF-BREEZE capital cost if it were to be built today was estimated to be 1.5-3.5 times higher than a comparable diesel ferry. O&M costs for the powerplant were estimated to also be higher, 2-8 times that of a comparable diesel, again due to the high current cost of PEM fuel cells. Bunkering LH₂ versus diesel provides another large difference in cost. When bunkering directly from a truck, there is essentially no cost for diesel fueling infrastructure. But due to the cryogenic nature of LH₂ even when bunkering from a truck there must be some installed equipment which can exceed \$900,000 for the first installation needed for the SF-BREEZE. Addition of an on-site LH₂ storage tank increase the cost of the bunkering facility by approximately \$600,000.

Today's cost of LH₂ was also considered. Estimates were obtained from the IGCs for 5-year agreements for the consumption volumes of the SF-BREEZE. IGC estimates for conventionally-produced (non-renewable) LH₂ available today ranged from a low of \$5.43/kg with a "take or pay" agreement and California's Low Carbon Fuel Standard (LCFS) credits, to a high of \$7.40/kg. IGCs were not able to provide estimates for 100% renewable, but the project team estimated a "take or pay" low of \$8.68/kg with LCFS credits to a high of \$21.58/kg by considering differences in renewable versus non-renewable feedstock and energy costs. Five-year fuel costs at today's prices were compared for the SF-BREEZE and a similar diesel ferry using today's ultra-low sulfur, non-road fossil diesel rate (\$2.15/gallon), and it was determined that today's fuel cost for the SF-BREEZE would be 3-5 times higher for the non-renewable LH₂ case and 5-16 times higher for the 100% renewable case.

The higher cost of the SF-BREEZE does not come without benefit: zero emission transport. The value of that is difficult to quantify in many respects, but the societal costs of pollution and greenhouse emissions have been established. Avoiding the estimated NO_x, PM, and GHG emissions associated with operating one SF-BREEZE ferry instead of one comparable ferry with Tier 4 diesel engines results in an estimated societal economic benefit of \$2,600,000 to \$11,000,000 over the 30-year lifetime of the ferry.

Cost reduction potential was discussed. First, however, the assumption of the need for cost parity with current diesel technology was examined in the context of fuel cell electric vehicles (FCEVs). In that market, despite similar cost premiums between the zero emission and conventional fueled versions of the vehicles, not only have vehicle manufacturers determined that they have enough commercial viability to launch a product in the market, they have also sold existing vehicle stock and have long waiting lists of customers.

Despite this, pathways towards cost parity were identified. In the long term, mass adoption of fuel cell electric vehicles will have an orders-of-magnitude effect on PEM fuel cell prices due to cost reductions of mass manufacturing. This alone would make the SF-BREEZE cost comparable to that of a diesel ferry. In the short term, however, one opportunity for cost reduction may be a decrease in vessel speed allowing for a smaller-sized powerplant. Combined with an increase in vessel size, the cost difference between a diesel ferry will become smaller as the cost contribution of the powerplant to the overall vessel cost decreases. In addition to reducing the capital cost premium, reducing the powerplant size

would reduce fuel consumption and the expense associated with that. As renewable energy generation and hydrogen production equipment matures and reduces cost, per-unit fuel costs will reduce as well. Available grant and incentive programs were also discussed as ways to reduce the capital and/or operating expense of the vessel.

With the technical and regulatory feasibility of the vessel and H₂ station established, the study concludes with recommended next steps. These include a design optimization of the SF-BREEZE prior to proceeding with the build of this groundbreaking vessel. This includes not only an examination of the tradeoff between speed and cost but also to include ideas such as changing the layout of the LH₂ tank and/or fuel cells to accommodate more passengers and reduce weight. The team recommends continued development of hydrogen-specific maritime regulations. On the policy side, zero emission mandates for marine transport are expected to be effective in encouraging further deployment of this technology, as it has with fuel cell electric vehicles (which also have similar significant cost premiums compared to their conventional fuel counterparts).

The SF-BREEZE feasibility study has shown that it is possible to build and operate a 150 passenger, high speed, zero emission hydrogen-powered ferry and its associated hydrogen station with no technical or regulatory show-stoppers identified, and that the vessel will be acceptable from a regulatory perspective once a more detailed “ready-to-build” design is generated. Commercially, the SF-BREEZE has a promising future and may be viable today.

Contents

Acknowledgements.....	4
Executive Summary.....	6
Contents.....	13
Figures.....	18
Tables.....	23
Nomenclature.....	25
1 Introduction.....	27
1.1 Project Goal.....	27
1.2 Motivation.....	27
1.3 Approach.....	32
1.3.1 Task 1: Ferry Technical Feasibility.....	32
1.3.2 Task 2: Fueling Facility Technical Feasibility.....	33
1.3.3 Task 3: Ferry Economics.....	33
1.3.4 Task 4: Fueling Facility Economics.....	33
1.3.5 Task 5: Regulatory Requirements.....	33
1.3.6 Partners.....	33
1.4 Content of the Report.....	37
2 Background.....	38
3 Ferry.....	41
3.1 Technical Assessment.....	41
3.1.1 Performance requirements.....	41
3.1.2 Power Plant Selection.....	43
3.1.2.1 Types of Fuel Cells and Selection.....	44
3.1.2.1.1 Solid Oxide Fuel Cells:.....	45
3.1.2.1.2 Molten Carbonate Fuel Cells.....	45
3.1.2.1.3 Phosphoric Acid Fuel Cell (PAFCs).....	46
3.1.2.1.4 Alkaline Fuel Cell (AFCs).....	48
3.1.2.1.5 Proton Exchange Membrane (PEM) Fuel Cells.....	48
3.1.2.2 Comparison with Battery Technology.....	52
3.1.2.3 Summary of Powerplant Selection.....	53
3.1.3 Hydrogen Storage Selection.....	54

3.1.3.1	High Pressure Gas	55
3.1.3.2	Solid-State Hydrogen Storage	59
3.1.3.3	Liquid Hydrogen (LH ₂)	62
3.1.3.4	Summary of the Hydrogen Storage Selection	69
3.1.4	Vessel Design	69
3.1.4.1	Design Study Report.....	71
3.1.4.2	Qualitative Hullform Comparison Study	71
3.1.4.3	Parametric Weight Estimate	71
3.1.4.4	Speed and Powering Calculations	72
3.1.5	Emissions of Greenhouse Gases and Criteria Pollutants	73
3.1.5.1	Vessel Energy	74
3.1.5.2	Power Plant Efficiencies	76
3.1.5.3	Results: GHG Emissions.....	77
3.1.5.4	Results: Criteria Pollutant Emissions.....	85
3.1.5.5	Summary	91
3.2	Regulatory Assessment	92
3.2.1	Relevant Standards (Design Basis)	93
3.2.2	Fire Protection.....	94
3.2.2.1	Fire on Upper Deck	94
3.2.2.2	Fire in the Fuel Cell Room	94
3.2.2.3	Fire Barrier Insulation	95
3.2.3	Hazardous Zones	95
3.2.3.1	IGF Code Paragraph 6.7.2.8 (Pressure Relief Valve Outlets)	96
3.2.3.2	IGF Code Paragraph 13.3.5 (Air Inlets).....	96
3.2.4	LH ₂ Tank and Vaporizers	96
3.2.5	Vessel Operation	98
3.2.6	LH ₂ as a Vessel Fuel (With Comparison to LNG)	98
3.2.6.1	Background	98
3.2.6.2	Physical Properties.....	99
3.2.6.2.1	Permeation	101
3.2.6.2.2	Embrittlement.....	103
3.2.6.3	Spills	103

3.2.6.4	Combustion Properties	105
3.2.6.5	Spontaneous Ignition	105
3.2.6.6	Explicit Ignition	106
3.2.6.6.1	Fires	107
3.2.6.6.2	Explosion and Detonation	108
3.2.6.6.3	Deflagration to Detonation Transition (DDT)	110
3.2.6.7	Pool Fires	116
3.2.6.8	The Hindenburg	120
3.2.6.9	Summary	121
4	Hydrogen Fueling Infrastructure	123
4.1	Technical Assessment	123
4.1.1	Performance Requirements	123
4.1.2	Design and Function	124
4.1.2.1	System Operation	126
4.1.2.2	LH ₂ Source Tank	127
4.1.3	Siting and Location	129
4.1.3.1	Treasure Island – Pier 1	130
4.1.3.2	Port of San Francisco	132
4.1.3.2.1	Pier 40 and All Piers North	133
4.1.3.2.2	Pier 48	133
4.1.3.2.3	Pier 50	133
4.1.3.2.4	Pier 54	133
4.1.3.2.5	Piers 64-70	136
4.1.3.2.6	Portrero Power Plant Site	136
4.1.3.2.7	Pier 80	136
4.1.3.2.8	Pier 90	137
4.1.3.2.9	Piers 92 and 94	139
4.1.3.2.10	Pier 96	139
4.1.3.2.11	South of Pier 96	141
4.1.3.3	Vallejo	141
4.1.3.4	Port of Redwood City	142
4.1.4	Hydrogen Supply	144

4.1.4.1	On-site Generation of Liquid Hydrogen	145
4.1.5	Co-location with Hydrogen Vehicle Fueling	146
4.1.5.1	Benefits to the Vessel	146
4.1.5.2	Benefits for the Vehicles	147
4.1.6	Passenger Embarkation.....	148
4.2	Regulatory Assessment	148
4.2.1	General.....	150
4.2.2	33 CFR Part 127	151
4.2.3	29 CFR Part 1910.119 (OSHA PSM)	151
4.2.4	USCG NVIC 01-2011	152
4.2.5	USCG OES Policy Letters 01-15 and 02-15	152
4.2.6	<i>ABS' LNG Bunkering: Technical and Operational Advisory and Bunkering of Liquefied Natural Gas-fueled Marine Vessels in North America</i>	152
5	Economic Assessment.....	153
5.1	Ferry	153
5.1.1	Capital Cost	153
5.1.2	Operating and Maintenance Cost	155
5.2	LH ₂ Facility.....	157
5.3	LH ₂ Fuel	159
5.4	Hydrogen Vehicle Fueling Station	165
5.5	Societal Economic Benefit.....	165
5.6	Overall Economic Conclusions	168
5.6.1	Future Outlook.....	168
5.6.2	Parallels to Fuel Cell Electric Vehicles	169
5.6.3	Today's Cost Reduction Strategies.....	170
5.7	Incentive and Grant Programs	170
5.7.1	Federal Programs	170
5.7.2	State of California Programs	171
5.7.3	Other Opportunities.....	172
6	Conclusions and Recommendations for Future Development	173
6.1	Recommendations	173
6.1.1	Examination of Optimal Performance Requirements for the SF-BREEZE	173

6.1.2	Technical Topics for Future Study	175
6.1.3	Regulatory Topics for Future Study	176
6.1.4	Policy Recommendations	176
6.1.5	Implementation Recommendations	176
7	References	178
Appendix A: Elliott Bay Design Group Design Package		
Appendix B: Vessel Design Approval in Principle (AIP) from the American Bureau of Shipping		
Appendix C: Letters of Support		
Distribution		

Figures

Figure 1: Example pathways for renewable (zero GHG) liquid hydrogen production based on steam methane reforming biomethane feedstock or electrolysis of water using renewable electricity.	29
Figure 2: (1) In the engine room of one of RWF’s vessels. (2) Visiting Pier 96 at the Port of San Francisco. (3) With the fuel cell mobile light at the Port of Redwood City. (4) At NASA Kennedy Space Center’s CryoTest Lab. (5) At Cal State Los Angeles’ hydrogen vehicle fueling station. (6) Tour of UC Berkeley’s hydrogen vehicle fueling station.	35
Figure 3: (1) Initial design review meeting at Elliott Bay Design Group. (2) Project kickoff meeting at DOT/MARAD. (3) Regulatory review meeting at ABS including members of the project team and USCG. (4) Regulatory review meeting at USCG Sector San Francisco.	36
Figure 4: (1) Witnessing Linde’s LH ₂ supply operation at AC Transit, Emeryville CA. (2) Visiting the Air Liquide hydrogen fueling station in Paris, France. (3) Touring the Air Products hydrogen fueling station in Allentown PA. (4) Site visit to Praxair’s LH ₂ production facility in Ontario, CA.	37
Figure 5: Existing ferry route for the <i>Vallejo</i> , providing ferry service between Vallejo, CA and San Francisco, CA.	41
Figure 6: Route profile (speed versus time) for a one-way trip from the Vallejo, CA Ferry Terminal to the San Francisco Ferry Building Terminal onboard the <i>Vallejo</i> Ferry.	42
Figure 7: General diagram of a fuel cell, reproduced with modification from Reference [40].	44
Figure 8: Bloom Energy ES-5700 solid oxide fuel cells, each producing power at 210 kW each. Photo from Reference [43].	45
Figure 9: Fuel Cell Energy DFC300 MCFC power plant. Photo from Reference [44].	46
Figure 10: Doosan 440 kW PureCell Model 400 PAFC. Photo from Reference [45].	47
Figure 11: Fuji Electric 105 kW, Model FP-100i PAFC. Photo from Reference [47].	47
Figure 12: Schematic Diagram of a Proton Exchange Membrane (PEM) Fuel Cell.	48
Figure 13: Ballard 90 kW FC Velocity HD PEM fuel cell. Photo from Ballard’s website.	50
Figure 14: Hydrogenics 33 kW HyPM HD30 PEM fuel cell. Photo from Reference [50].	50
Figure 15: Assembly of four Hydrogenics HyPM HD30 PEM fuel cell into a fuel cell power rack. Background photos courtesy of Ryan Sookhoo, Hydrogenics [49].	51
Figure 16: Photographs of three types of high-pressure hydrogen storage tanks: (a) carbon steel; (b) composite and (c) metal hydride.	56
Figure 17: Relationship between molar volume V_m and pressure for hydrogen using the Abel-Noble equation of state (black curve) and the ideal gas law (red curve).	58
Figure 18: A “pod” formed from assembling together 20 Luxfer Model W320H 5,000 psi hydrogen storage tanks: (Top) end view; (Bottom) side view. Drawings are not to scale.	59
Figure 19: Examples of LH ₂ tanks: (a) Chart Inc. LH ₂ tank; (b) Linde Group LH ₂ tank at the AC Transit Hydrogen Station in Emeryville CA and (c) Linde LH ₂ refueling trailer at the AC Transit Station.	63

Figure 20: Photographs of a Linde ISO LH₂ container (tank) mounted on a trailer. The rectangular frames on the tank allow for convenient lifting and transport. The specifications written on the side of the tank are shown in the lower picture..... 65

Figure 21: Cross section of a typical road-transport LH₂ tank showing the double liner approach (not to scale). The double liner provides ultra-insulation properties as well as extremely high resistance to damage. The SF-BREEZE will use the same kind of tank. 66

Figure 22: Dual vent stacks on the LH₂ tank at the AC Transit Hydrogen Station in Emeryville CA. (a) Vent exit ports; (b) cold hydrogen gas from the Linde trailer being vented out the LH₂ tank hydrogen vent stacks and (c) close-up of the strong buoyant behavior of even very cold hydrogen gas during the vent of the Linde trailer. The plumes in pictures (b) and (c) are water condensation clouds (fog) from the release of cold hydrogen gas. Note that the SF-BREEZE tank would never vent such large quantities of hydrogen gas..... 67

Figure 23: A diagram depicting the venting of hydrogen gas out of a single vent stack exit port. The horizontal and vertical dimensions of the diagram are not to scale. 68

Figure 24: Final engineering models of the SF-BREEZE as designed by Elliott Bay Design Group. The top deck holds the LH₂ storage tank, the associated vent stack, evaporation equipment, and the Pilot House of the vessel. The main deck holds the PEM fuel cell power racks and the passenger compartment. 70

Figure 25: (Top): Engineering model for the SF-BREEZE. (Bottom): Photograph of the *Vallejo* ferry..... 73

Figure 26: Thermal efficiency of the SF-BREEZE HD-30 PEM fuel cell (thick blue line) and the Vallejo’s MTU 16V4000 diesel engine (thin red line) as a function of the partial load. For the HD-30, the maximal power (100% load) is 33 kW. For one of the MTU 16V4000 diesel engines, the maximal power is 1700 kW. The figure assumes a LHV value of hydrogen of 119.96 MJ/kg, and a LHV value for diesel fuel of 43.4 MJ/kg. 76

Figure 27: WTT LH₂ pathways considered in the GHG analysis of the SF-BREEZE and *Vallejo* Ferries. Pathway codes in parenthesis identify the pathway describe in detail in the European Commission [64, 65]. 80

Figure 28: Total fuel pathway (WTT) GHG emissions in grams CO₂ (eq.)/MJ_{fuel} for the LH₂ production pathways considered in this study: (L-R); NG reforming, electrolysis of water using the EU grid mix, wood gasification, water electrolysis using nuclear-based electricity, water electrolysis using wind-based electricity, and the average of the renewable paths. The figure reports the GHG emissions associated with producing one MJ of finished fuel on a LHV basis, MJ_{fuel}. GHG emissions in units of grams CO₂ (eq.)/MJ_{fuel} are given for the LH₂ production pathways considered in this study. The figures report the GHG emissions associated with producing one MJ of finished fuel on a LHV basis, MJ_{fuel}. 81

Figure 29: Predicted well-to-waves (WTW) GHG emissions per passenger for the SF-BREEZE and the *Vallejo* for the Vallejo-San Francisco route described in Figure 5 and Figure 6 and in Table 1. Emissions are given based on a one-way trip. Note the change in vertical scale units from Figure 28 to Figure 29, from grams CO₂ (eq.) (Figure 28) to kilograms CO₂ (eq.) (Figure 29)..... 84

Figure 30: Predicted well-to-waves (WTW) criteria pollutant emissions per passenger for the SF-BREEZE and the <i>Vallejo</i> on the Vallejo-San Francisco route described in Figure 5 and Figure 6 and in Table 1. Emissions are given based on a one-way trip. The SF-BREEZE carries 150 passengers, while the <i>Vallejo</i> carries 300 passengers. The <i>Vallejo</i> engine emissions are set equal to the Tier 4 limits for both fossil diesel and biodiesel operation.	89
Figure 31: Schematic of the fuel system on-board the SF-BREEZE highlighting the location of the redundant vaporizers and cross-connected supply piping. For the accompanying bunkering station schematic see Figure 43.	97
Figure 32: The terminal rising velocity for spherical volumes of hydrogen and methane in air at NTP (293.15 K, 1 atmosphere pressure). The figure assumes NTP gas densities of 1.204 kg/m ³ for air, 0.08376 kg/m ³ for hydrogen and 0.65119 kg/m ³ for methane.	100
Figure 33: Cutaway view of the Main Deck of the SF-BREEZE. The PEM fuel cells are distributed into a Starboard Fuel Cell Room and a Port Fuel Cell Room, with ~ 20 fuel cell racks in each room. The Passenger Compartment holds 150 passengers. The “beam” (width) of the SF-BREEZE is 10 m.	111
Figure 34: Schematic of the Sandia FLAME facility. Figure is reproduced with modification from Reference [110].	112
Figure 35: Planar flame speed plotted against distance from the ignition end in FLAME experiments. Obstacles were removed from the tunnel for these measurements. The figure uses data reported in Reference [110].	112
Figure 36: Planar flame speed plotted against distance from the ignition end in FLAME experiments. Obstacles were placed in the tunnel for these measurements. The figure uses data reported in Reference [110].	113
Figure 37: Experimental setup for the experiments reported in Reference [112]. Figure reproduced from Reference [112].	115
Figure 38: High-speed optical video images of hydrogen combustion for a 30% hydrogen/air mixture, ignited with a 40 J spark. Figure reproduced from Reference [112].	116
Figure 39: High-speed optical video images of hydrogen combustion for a 30% hydrogen/air mixture, ignited with 10 grams of C-4 high explosive. Figure reproduced from Reference [112].	116
Figure 40: A 10-m diameter LNG pool fire from the Sandia Phoenix Tests. Figure reproduced from Reference [117].	118
Figure 41: Photographs of the <i>Hindenburg</i> disaster (from public record).	121
Figure 42: Conventional diesel fueling operation at the Red and White Fleet. The diesel truck (left) is transferring fuel through the red hose to the vessels in the background.	124
Figure 43: Flow schematic of an LH ₂ bunkering facility (left) and, for process clarity, associated on-board LH ₂ system (right). Only major components and features are shown.	125
Figure 44: LH ₂ transfer operation at AC Transit, Emeryville, CA, performed by Linde.	126
Figure 45: Map of the Bay Area showing a 5 nm radius from the San Francisco Ferry Building and some of the potential bunkering locations evaluated in the study.	130
Figure 46: Satellite view of Treasure Island. Pier 1 is in the lower right (southeast) corner.	131

Figure 47: Potential layout of hydrogen infrastructure on Treasure Island Pier 1, including both the equipment for bunkering vessels with LH ₂ (right) and that needed for refueling land-based hydrogen vehicles (left). The placement of equipment is flexible; this is just one example. Design and drawings courtesy of Linde.....	131
Figure 48: Property owned by the Port of San Francisco (shown in orange shading). Pier numbers relevant to the discussion are overlaid for reference. Map from Ref. [135].	132
Figure 49: Satellite view of San Francisco Pier 54. A potential facility layout detail (red outline) is shown in Figure 51. The dashed yellow line indicates the approximate boundary of Port-owned land.	134
Figure 50: Pier 54 location and surrounding area. Background photo from Ref. [137]	135
Figure 51: Example layout of hydrogen equipment at Pier 54’s northwest berth supporting a vehicle fueling station and direct truck-to-vessel LH ₂ bunkering. For orientation see inset on Figure 49. Layout courtesy of Linde.	135
Figure 52: Satellite view of Pier 80, San Francisco CA.	136
Figure 53: Example layout of hydrogen infrastructure at Pier 80. The vessel at “A” berth would be at the bottom right. This layout assumes bunkering directly from an LH ₂ trailer into the vessel. It also includes equipment needed for refueling land-based hydrogen vehicles and parking for passengers. Design and drawing courtesy of Linde.	137
Figure 54: Satellite view of Pier 90.	138
Figure 55: Example layout of hydrogen infrastructure at Pier 90. In this embodiment, the dilapidated section of the pier is replaced. The vessel berth is at the top right. This layout assumes bunkering directly from an LH ₂ trailer into the vessel. It also includes equipment needed for refueling land-based hydrogen vehicles and parking for passengers. Design and drawing courtesy of Linde.....	139
Figure 56: Satellite view of Pier 96 showing location of the southwest berth and the vehicle route (red dashed line).	140
Figure 57: The open area of Pier 96 hosts the City of San Francisco Police Department’s driver training course.	140
Figure 58: Layout of the existing Vallejo ferry terminal (right side of the Mare Island Strait) and San Francisco Bay Ferry’s ferry base (left side).	141
Figure 59: Passenger ferry dock at Vallejo. The ticket office and lobby is in the building in the far right background.....	142
Figure 60: Port of Redwood City map showing the five wharfs.	143
Figure 61: View on Wharf 5 looking south/west. The pier is well maintained, wide, structurally sound, and available.	143
Figure 62: Example layout of hydrogen equipment at Wharf 5 at the Port of Redwood City. This layout assumes bunkering directly from an LH ₂ trailer into the vessel. It also includes equipment needed for refueling land-based hydrogen vehicles and parking for passengers. Layout by author, based on equipment needs and dimensions from Linde.	144
Figure 63: Hydrogen vehicle fueling station in Torrance, CA.....	146
Figure 64: Graphical summary of codes applicable to LNG bunkering, from Ref. [146].	150

Figure 65: Average cost of different types of purchased power by California’s Investor Owned Utilities. Figure 3.5 from Reference [161]. See footnote in text for definition of acronyms..... 161

Figure 66: Distribution of type of power purchased by California’s Investor Owned Utilities from Qualifying Facilities (generators). Figure 3.2 from Reference [161]. See footnote in text for definition of acronyms. 162

Figure 67: Speed/passenger profile of US passenger ferries in 2014. Data from Ref. [39] excluding vessels that did not report passenger count or speed. 174

Figure 68: Speed profile of US passenger ferries in 2014. Data from Ref. [39], excluding non-powered barges and vessels with unreported speeds. 174

Tables

Table 1: Vallejo to San Francisco Ferry Route Details. Step Distance (in nautical miles, nm), Cumulative Distance, Step Speed, Step Duration and Cumulative Time for a one-way trip onboard the <i>Vallejo</i> from the Vallejo Ferry Terminal in Vallejo, CA to the San Francisco Ferry Building Terminal in San Francisco, CA.....	42
Table 2: Types of Fuel Cells, from Ref. [40].....	44
Table 3: Gravimetric and volumetric specs for the fuel cell technologies discussed.	51
Table 4: Summary of candidate power plants for a high-speed ferry. The compatibility of a technology with the SF-BREEZE objectives is indicated with a check or X mark. A red X signifies “No,” a green check signifies “Yes.”	53
Table 5: Gravimetric and Volumetric Storage Specifications (specs) for the hydrogen storage methods discussed. See the text for definitions of the storage specs.	55
Table 6: Vallejo to San Francisco Energy Requirements for the SF-BREEZE. The energy demands on the SF-BREEZE for performing each step of the Vallejo to San Francisco Ferry route are listed. The lower heating value (LHV) of the LH ₂ fuel needed to perform the step is also shown, which is a function of the fuel cell (FC) thermal efficiency appropriate for that step. The hydrogen LHV is 119.96 MJ/kg. The total engine energy (service energy + propulsion energy) needed for the one-way trip is 1.125 x 10 ¹⁰ J. The total hydrogen fuel energy (LHV) needed for the one-way trip is 2.39 x 10 ¹⁰ J.	75
Table 7: The energy demands on the <i>Vallejo</i> ferry for performing each step of the Vallejo to San Francisco Ferry route. The lower heating value (LHV) of the diesel fuel needed to perform the step is also shown, which is a function of the diesel engine thermal efficiency appropriate for that step. The fossil diesel fuel LHV is 43.4 MJ/kg. The total engine energy (service energy + propulsion energy) needed for the one-way trip is 8.78 x 10 ⁹ J. The total diesel fuel energy (LHV) needed for the one-way trip is 2.17 x 10 ¹⁰ J.	75
Table 8: A comparison of the 2007 EU grid mix assumed in the studies of Reference [64] with the 2014 State of California grid mix described in Reference [66].	80
Table 9: WTT criteria pollutant emissions for fuel pathways on a LHV basis. GJ _{fuel} represents the lower heating value (LHV) of the indicated fuel in gigajoules (GJ). 1 GJ = 1 x 10 ⁹ J.....	87
Table 10: Fuel pathway (WTT) criteria pollutant emissions and well-to-waves (pathway + engine, WTW) emissions on a grams per passenger/trip basis calculated for the SF-BREEZE and the <i>Vallejo</i> for the Vallejo to San Francisco route of Figure 5. The SF-BREEZE carries 150 passengers, while the <i>Vallejo</i> carries 300 passengers. The engine criteria pollutant emissions of the <i>Vallejo</i> are set to the Tier 4 limits for both fossil diesel and biodiesel operation.	88
Table 11: Well-to-waves criteria pollutant and GHG emissions (in grams) reported per integrated engine output energy (in MJ and kW-hr) for the SF-BREEZE and the <i>Vallejo</i> for the Vallejo-San Francisco route described in Figure 5 and Figure 6 and in Table 1.	91
Table 12: Predicted size and duration of instantaneous LH ₂ and LNG spills on solid ground from LAUV model, from Ref. [95].	104
Table 13: Physical and Combustion Property Values for Hydrogen and Methane.....	106

Table 14: Summary of SF-BREEZE capital cost estimates including that of a comparable new-build diesel powered ferry.....	154
Table 15: Estimated yearly O&M costs for the powerplant of the SF-BREEZE and comparable diesel vessels.....	157
Table 16: Estimated capital cost of an LH ₂ bunkering facility, excluding any necessary improvements to the host dock or pier.....	159
Table 17: Estimated Low Carbon Fuel Standard (LCFS) credits for hydrogen from three production scenarios.	163
Table 18: Summary of expected LH ₂ costs for the SF-BREEZE today.....	164
Table 19: Comparison of total fuel costs for five years of operating the SF-BREEZE with LH ₂ using unit hydrogen costs from Table 18, and a ferry with the same yearly route profile powered by ultra-low sulfur diesel (ULSD) at today's prices.....	164
Table 20: Yearly well-to-waves pollutant emissions of a comparable ferry with Tier 4 diesel engines, the SF-BREEZE, and the annual emissions avoided by building and operating one SF-BREEZE ferry instead of one Tier 4 diesel ferry.....	166
Table 21: Summary of societal economic benefit by building and operating one SF-BREEZE ferry for 30 years instead of one comparable conventional ferry with Tier 4 diesel engines. Estimates rounded to two significant figures in this table, but all calculations are performed with the unrounded estimates.	167
Table 22: Summary of economic costs and benefits of the SF-BREEZE, including future outlook, with comparison to conventional diesel.....	168

Nomenclature

ABS	American Bureau of Shipping
ACH	Air Changes per Hour
AFC	Alkaline Fuel Cell
AFFF	Aqueous Film Forming Foam
AIP	Approval in Principle
ARB	[California] Air Resources Board
BAAQMD	Bay Area Air Quality Management District
BEV	Battery Electric Vehicle
CARB	California Air Resources Board
CEC	California Energy Commission
CFR	Code of Federal Regulations
CTMV	Cargo Tank Motor Vehicle
DBL	Design Basis Letter
DDT	Deflagration to Detonation Transition
DNV	Det Norske Veritas
DOT	Department of Transportation
DSR	Design Study Report
EBDG	Elliott Bay Design Group
EEDI	Energy Efficiency Design Index
EPA	Environmental Protection Agency
EU	European Union
FCEV	Fuel Cell Electric Vehicle
GHG	Greenhouse Gas
GDP	Gross Domestic Product
HC	Hydrocarbon
ICE	Internal Combustion Engine
IGC	Industrial Gas Company
IGF	International Gas Fuel [Code]
IMO	International Maritime Organization
IR	Infrared
ISO	International Standards Organization
LCFS	Low Carbon Fuel Standard
LEL	Lower Explosive Limit
LFL	Lower Flammability Limit
LHV	Lower Heating Value
LNG	Liquefied Natural Gas
LTSA	Long Term Service Agreement
M&R	Maintenance and Repair
MARAD	Maritime Administration
MCFC	Molten Carbonate Fuel Cell
MMT	Million Metric Ton
NASA	National Aeronautics and Space Administration
NG	Natural Gas
NOx	Oxides of nitrogen
NTP	Normal Temperature and Pressure
O&M	Operation and Maintenance

OSHA	Occupational Safety and Health Administration
PAFC	Phosphoric Acid Fuel Cell
PEM	Proton Exchange Membrane
PM	Particulate Matter
PSM	Process Safety Management
RWF	Red and White Fleet
SCC	Social Cost of Carbon
SCI	Structural Composites Industries
SF	San Francisco
SF-BREEZE	San Francisco Bay Renewable Energy Electric vessel with Zero Emissions
SMR	Steam Methane Reforming
SOFC	Solid Oxide Fuel Cell
UEL	Upper Explosive Limit
UFL	Upper Flammability Limit
ULSD	Ultra-low Sulfur Diesel
USCG	United States Coast Guard
USPS	United States Postal Service
WETA	Water Transit Emergency Authority
WTT	Well-to-Tank
WTW	Well-to-Waves
ZEV	Zero Emission Vehicle

1 Introduction

This chapter discusses the project goal, motivation, and approach, and gives an overview of this report.

1.1 Project Goal

The goal of this project is to:

Determine the technical, regulatory, and economic feasibility of a high-speed passenger ferry powered solely by hydrogen fuel cells and its associated hydrogen fueling infrastructure within the context of San Francisco Bay, California, USA.

1.2 Motivation

The International Maritime Organization's (IMO) *Third IMO GHG Study 2014* [1] comprehensively describes the expected increases in worldwide shipping emissions over the next 35 years as global GDP increases and marine transportation increases along with it. The study examines various cases of shipping types, efficiency improvements, and fuel types and concludes that even with projected improvements, in 2050 GHG emissions will be between 50% to 250% higher than 2012 levels.

Particularly important are the following observations about GHG emission projections (underline added for emphasis) [1]:

The emissions projections show that improvements in efficiency are important in mitigating emissions growth but even the most significant improvements modelled do not result in a downward trend. Compared to regulatory or market-driven improvements in efficiency, changes in the fuel mix have a limited impact on GHG emissions, assuming that fossil fuels remain dominant.

In other words, despite reductions in per-unit GHG emissions due to fuel changes, efficiency improvements, etc., the increase in maritime transportation activity will still result in an overall increase in sector GHG emissions as long as fossil fuels are the primary fuel. The way to truly reduce GHG emissions in the face of increasing transportation is to transition to zero GHG-emitting energy production.

Since January 2013 energy efficiency regulations have been in place for large new ocean-going vessels such as tankers, bulk carriers, gas carriers and container ships. Known as the "Amendments to MARPOL Annex VI," the Energy Efficiency Design Index (EEDI) is the first legally binding global mandatory GHG emission reduction regulation since the 1997 Kyoto Protocols. The regulation requires a "phased in" increase in vessel energy efficiency, thereby reducing both GHG and criteria pollutant emissions, to an ultimate target of 30% improvement by 2025 and beyond.[2] Unfortunately, the benefits derived from the 30% reduction in emissions will be eroded by expected increase in the size of the fleet of such vessels in the near future. There has yet to be established GHG regulations for the smaller passenger vessels ("ferries") being considered here.

On a more local level, the California Air Resources Board (ARB) has estimated that the total GHG emissions for the State of California in 2014 were 441.5 MMT CO₂ (eq.).[3] ARB has also made emissions estimates for "harbor craft," defined as all vessels that operate within California coastal

waters and inland waterways, and has a home port located in California. By definition, harbor craft excludes the large international cargo vessels, but includes ferries. The California ARB estimates harbor craft GHG emissions in 2014 were 1.548 MMT CO₂ (eq.).[3] Thus, in California, harbor craft account for 0.35% of the statewide California GHG emissions, in good accord with the 2007 global estimate [4] for fractional GHG emissions from such vessels.

As for criteria pollutant emissions, ARB data indicate that harbor craft emitted 2.8% of the NO_x emissions in the State of California, 0.095% of the HC emissions, and 0.10% of the PM emissions in the State. Although these numbers may seem small, as noted by Corbett and Farrell [5], emissions from passenger ferries constitute a highly visible pollution source in close proximity to dense population areas where emissions most adversely affect human health. Indeed, the California ARB considers passenger ferries, along with other commercial harbor craft, to be important sources of pollutant emissions in California, especially in coastal areas with high marine activity. In 2004, ARB estimated that emissions from commercial harbor craft in the San Francisco Bay Area Air Quality Management District (BAAQMD) were equivalent to nearly 60% of the heavy-duty diesel trucks in the area.[6]

Consequently, criteria pollutant emissions from harbor craft have come under increasing levels of regulation (see subsections (e)(4) and (e)(5) of Ref. [7]). In 1999, the U.S. Environmental Protection Agency (EPA) instituted the Tier 1 Marine Engine Standards for powerplants 37 kW or greater and cylinder displacements of 2.5 liters/cylinder or greater.[8] These regulations were enforced on engines built in the model year 2004. Stricter U.S. EPA Tier 2 regulations were created to cover marine engines built in model year 2007. These criteria emission regulations were followed by the U.S. EPA Tier 3 Marine Standards for marine diesel Category 1 engines with power 3700 kW or smaller, with the Tier 3 standards imposed on engines built in the 2012 – 2014 timeframe. The current U.S. EPA regulations for criteria pollutant emissions from marine propulsion engines are the Tier 4 Marine Standards.[9] Any new build of a passenger ferry in the U.S. must adhere to the Tier 4 emission standards for engines above 600 kW (800 hp). For the passenger ferry discussed here, the engines are Category 1 with power 1700 kW each, for which the following Tier 4 emission limits are set per propulsion engine output energy: NO_x = 1.8 g/kW-hr, HC = 0.19 g/kW-hr and PM = 0.04 g/kW-hr.

Keller et al. [10] have provided a compelling argument that if we are going to solve our fuel resource insecurity, political energy insecurity and environmental sustainability problems that accompany our current fossil-fuel-based energy infrastructure, we as a civilization are going to need to turn to hydrogen. For significant environmental benefits, particularly with regard to reduction of greenhouse gas (GHG) emissions, the hydrogen will need to be produced by renewable methods with minimal (close to zero) pathway GHG emissions. One can define a zero-carbon energy solution as an energy system in which there is no net release of CO₂ or other GHGs into the atmosphere, either at the point of technical use, or along the path used to produce the fuel. Unless we have a new transportation technology with emissions reductions approaching 80% or more, the emission reductions will not be robust against growth in either population, or growth in the intensity with which technology uses energy [10]. Such deep cuts are consistent with recommendations from the Intergovernmental Panel on Climate Change (IPCC) [11] and U.S National Academy of Sciences studies [12]. While use of fossil-based hydrogen allows the introduction of the hydrogen-based power conversion technology [11], ultimately renewable

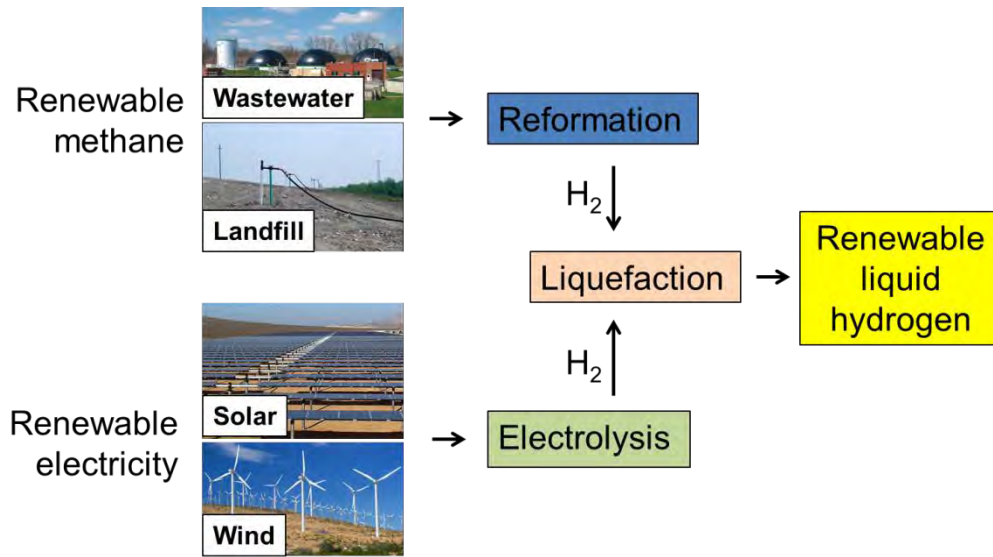

Figure 1: Example pathways for renewable (zero GHG) liquid hydrogen production based on steam methane reforming biomethane feedstock or electrolysis of water using renewable electricity.

hydrogen may be required to provide the GHG reduction commensurate with the global climate change problem. The time-scales for technological change and the ~50-year horizon associated with our limited fossil fuel resources indicate that we have to start the conversion to a renewable hydrogen technology now, and we need to be going much faster than we are [13].

Hydrogen enables a zero-GHG and zero-criteria pollutant energy pathway. Figure 1 shows an example of how renewable (zero GHG and criteria pollutant) liquid hydrogen can be obtained. If the other energy inputs to the process are renewable (such as electricity for compression or liquefaction) and the hydrogen is then transported in a renewable way (via biofuel or hydrogen-powered truck) to the vessel and used in fuel cell, there are no GHG or criteria pollutant emissions throughout the production and use cycle.

Hydrogen can also be made from non-renewable natural gas (as a gas or as LNG) through steam reformation. However, the well-to-waves GHG emissions associated with obtaining the natural gas and the reformation results in only modest GHG reductions compared to using fossil fuels directly in combustion engines.

As reviewed by Klebanoff et al. [14], high efficiency hydrogen energy conversion devices that convert hydrogen into electrical or shaft power are powerful drivers for hydrogen technology. These conversion devices include hydrogen internal combustion engines (ICEs), both spark ignition and turbine hydrogen engines, along with hydrogen fuel cells [14]. Proton Exchange Membrane (PEM) fuel cells in particular are already finding use in the first fuel cell vehicles, portable power, backup power, material handling equipment and fuel cell mobile lighting [14]. The use of hydrogen fuel cell technology for maritime applications is currently being considered and is briefly reviewed in Chapter 2.

Besides GHG reduction, using hydrogen for maritime transport has many more potential benefits. These were explored at the Zero Emission Hydrogen Vessel Workshop held February 26, 2016 hosted by

Sandia National Laboratories at the US DOT/Maritime Administration in Washington, DC. Workshop participants were a mix of public and private entities and included government representatives, regulators, class society, vessel owners and operators, hydrogen suppliers, and technology companies. The participants produced the following list of potential benefits of zero emission hydrogen vessels:

1. No air pollution from the exhaust. This characteristic has a myriad of benefits:
 - a. Clean air for passengers
 - b. No smell
 - c. Health benefit (need to quantify health benefits to crew and people near ports)
 - d. Easy to comply with criteria pollutant emissions (PM, SO_x, NO_x):
 - i. Avoidance of engine certification and compliance
 - ii. Unlimited operation in Environmental Compliance Area in the US and abroad
 - iii. Compliance with existing permit/regulations in CA
 - e. No need for exhaust scrubbers
 - f. No interference with environmental sampling
 - g. No soot means the vessel can operate in the arctic without worsening ice melting
2. The fuel is non-toxic, has no odor, and is not a greenhouse gas
 - a. Spills or releases will not affect climate change, will not harm health if breathed (except in large quantities – it is an asphyxiate).
 - b. Better consumer experience – no fuel fumes
 - c. No fuel spills since the hydrogen quickly evaporates/dissipates and removes itself from the environment
3. Potential use in the Arctic environment if cold is not an issue because the waxing/freezing problems with the petroleum-based fuels do not exist with hydrogen
4. The ability to generate the fuel in a renewable way has several potential benefits besides the fuel lifecycle emissions benefit:
 - a. Energy independence/use of domestically-produced renewable energy
 - b. Ability to use currently curtailed renewable solar and wind energy (regionally dependent)
 - c. Potentially can enable generation of renewable fuel at sea (by independent fuel island or on the vessel itself while loitering) and refueling during transit (need study)
5. Several potential cost benefits (needing further investigation):
 - a. More stable price certainty (insulates against fossil fuel price volatility)
 - b. Fuel cost savings if fossil fuels become more expensive (due to supply and/or carbon taxes).
 - c. Increased sales (market advantage): going “green” and/or “new technology”
 - d. Lower fuel operating cost
 - e. Less maintenance, higher reliability – less cost as well as potential for less required trained crew on-board
6. Safety
 - a. Potentially less hazardous / lower fire risk than other fuels
 - b. No need to heat the fuel above ambient temperature

- c. Potentially less inerting of spaces required
 - d. Potential weight savings if structural fire protection could be optimized
7. Ability to use fuel cells with some of their inherent differences to combustion engines
- a. Lower noise, vibration, heat signature (for some fuel cell types)
 - b. Enables vessel use in areas where noise could be an issue, e.g. research and fishing vessels, improving performance.
 - c. Compliance with potential future regulations on noise exposure of both crew/passengers as well as marine life.
 - d. Potential for less sound insulation needed on-board – saves weight and the current insulation used today (mass-loaded vinyl, MLV) emits toxic gases if it catches on fire making firefighting difficult
 - e. Better crew and customer experience
 - f. Faster power response (for some fuel cell types)
 - g. Fuel cells generate pure, deionized water which can be captured used for other purposes such as drinking or for experimental/analytical purposes. This can offset weight of potable or experimental water needed to be carried on-board.
 - h. The fuel cell's waste heat can be captured for use on the vessel. This may be easier due to the modular nature of the fuel cell – distributed heating.
8. Efficiency
- a. Higher efficiency power generation for propulsion and/or while docked
 - b. Power for propulsion and power for electrical load can be independently optimized for maximum efficiency.
 - c. Fuel cells have high efficiency at part load and can increase energy efficiency of the vessel when used for idling, loitering, or peak shaving
9. Electrification and Distributed Power – an all-electric vessel
- a. Power can be distributed around the vessel – more resilient and more reliable power system (however, distributed power may introduce negative issues. Fuel distribution and other balance of plant functions also need to be distributed. This increases the weight and complexity of the overall system).
 - b. Many small, identical power units possibly result in easier maintenance/reliability of the whole system
 - c. Shutdown of a single unit will have a minor effect on overall power output (compared to a single large engine)
 - d. Better on-board power quality available due to separation of power circuits for propulsion from those for hotel loads
 - e. Potential to supply ship-to-shore power to the port when at berth or in emergencies
 - f. Opens a new paradigm of designs: Ground-up designs leveraging hydrogen fuel cell unique distributable characteristics may lead to smaller ships requiring less power

This myriad of potential benefits motivates a detailed exploration into the technical, regulatory, and economic feasibility of designing, building, and operating a practical, commercial, zero emission vessel.

1.3 Approach

There are a great variety of marine vessels on the water operating in environments across the planet. Early in the project development process, the team decided to narrow the scope of this feasibility study to a specific vessel in a specific environment: a high-speed passenger ferry in the San Francisco Bay. The rationale for choosing this scope was twofold. First, the project concept was conceived by Tom Escher of the Red and White Fleet, which operates 300-550 passenger sightseeing excursion vessels from the Port of San Francisco. While sightseeing/excursion vessels were of immediate interest, the project team felt that high-speed passenger ferries would have higher commercial relevance in the Bay and be a more technically challenging application. The thinking was that learnings from examining a high-speed passenger ferry could be transferred to low speed passenger craft such as the sightseeing vessels, but not the other way around.

In addition, selecting a passenger vessel would force the project team to confront the regulatory and safety requirements that are of ultimate importance when the general public is involved. Therefore the high speed passenger ferry was selected in an attempt to give a broader applicability to the results. The location of San Francisco Bay was chosen based on the familiarity with it from members of the project team which would enable robust comparison to existing vessels and application to existing routes. The project subsequently adopted the name of its concept vessel: San Francisco Bay Renewable Energy Electric vessel with Zero Emissions (SF-BREEZE).

Having decided on the subject vessel and operating environment, the feasibility study was conducted through accomplishment of five tasks, all which were done through a team of partners and stakeholders.

1.3.1 Task 1: Ferry Technical Feasibility

Examine and determine whether or not such a vessel can be built, and the primary question there centers around the weight and volume of the hydrogen fuel cell system and its impact on vessel size and performance. While fuel cell sizes have continued to decrease, they are still not as compact as diesel engines on a power-per-weight or power-per-volume basis. Similarly, hydrogen storage systems take up 5-10 times the space as similarly-sized diesel fuel tanks and are about four times heavier. It is important that a naval architect experienced in vessels with electric drive systems and low flashpoint fuels (e.g., LNG) be involved with this part of the feasibility study. The naval architect provided:

- A “Qualitative Hull Comparison Study” which evaluated three candidate hulls (monohull, catamaran, and trimaran) across various characteristics. It includes sketches showing the different hulls with blocks for the propulsion motors, fuel cells, and hydrogen tanks and identifies a preferred configuration.
- For the selected hull configuration:
 - Outboard Profile and General Arrangement (including a 3-D rendering of the vessel with a hull cut-away to show hydrogen tanks, fuel cell, switchboard/transformer and propulsion motor)
 - Weight Estimate
 - Regulatory Review

- Tonnage and Subdivision
- Speed and Powering Calculations
- Construction Cost Estimate
- GHG and criteria H₂ production pathway emissions estimate.

This task also engaged the representative owner/operator (Red and White Fleet) for information on desired operational characteristics including performance expectations and realistic refueling scenarios, and Sandia for performing a safety assessment of on-board LH₂ relative to LNG.

1.3.2 Task 2: Fueling Facility Technical Feasibility

The technical feasibility study examined the requirements for a hydrogen fueling facility to support the boat. This included assessment of potential locations, bunkering (vessel fueling) procedures, and hydrogen supply methods. A hydrogen station of this magnitude would be one of the largest in the world and includes its own set of technical issues that must be identified and examined in the context of location along the waterfront of the San Francisco Bay. The logistical feasibility of a multi-use (vehicles, vessels) hydrogen station was also be part of this assessment. The ferry owner/operator, owners of potential sites, and users of the land-based vehicles were involved with this part of the study.

1.3.3 Task 3: Ferry Economics

The cost of designing, building, and operating the ferry must be understood to define the business case of the fuel cell boat. This cost assessment includes not only the costs needed for executing this project but also cost targets for future commercial versions of the boat for widespread use in a variety of applications including revenue ferry service. These include engineering, capital, operating, and recurring maintenance cost and will consider likelihood of local and regional incentive programs for clean transportation.

1.3.4 Task 4: Fueling Facility Economics

In addition to the economics of the ferry, the economics of the hydrogen station and resulting hydrogen cost were analyzed. It has been shown that large hydrogen stations provide the most cost-effective hydrogen prices based on economies of scale but this must be verified for the multi-use hydrogen station considered here. Existing work was leveraged to estimate station costs. Feedback from both hydrogen providers and land-based hydrogen users was important to obtain a realistic cost-benefit analysis for the multi-use characteristic.

1.3.5 Task 5: Regulatory Requirements

The regulatory (environmental, safety, permitting) aspects of both the ferry and the hydrogen station were examined. For the ferry, it was imperative that this included detailed discussions with US Coast Guard and a classification society (e.g., ABS) to determine the regulatory boundaries that govern hydrogen fuel cells providing main propulsive power for passenger vessels. This information was needed to determine the regulatory feasibility of the design.

1.3.6 Partners

The primary partners and their roles in the project were as follows:

Sandia National Laboratories: Project lead, independent feasibility assessment; unbiased determination of commercial, technical, and environmental value propositions; hydrogen fuel cell technology and systems; hydrogen storage; hydrogen safety, codes, and standards; coordination with ports, SF City/County, CA State and U.S. Federal agencies; project integration issues (fuel cell, boat, hydrogen supply).

Red and White Fleet: Boat operator, operation data provider, evaluator for commercial value proposition.

US Department of Transportation/Maritime Administration: Sponsor, evaluator for port emissions reduction initiatives

US Coast Guard: Reviews vessel design for acceptable safe deployment of hydrogen fuel cells for propulsion on passenger vessels. Uses project to develop national and international hydrogen maritime standards.

American Bureau of Shipping: Reviews vessel design for acceptable safe deployment of hydrogen fuel cells for propulsion on passenger vessels. Uses project to assist in developing rules and recommendations for future hydrogen vessels.

Port of San Francisco and Port of Redwood City: Evaluation of sites for bunkering and passenger embarkation, coupling to land vehicle fleets.

Elliot Bay Design Group: Performs concept design of the vessel to meet the project team's specifications. Works directly with USCG and ABS to address regulatory acceptance issues.

Equipment and Hydrogen Suppliers: Provides equipment specifications and engineering guidance for on-board systems and the bunkering station. Provides cost estimates and availability information. Works with the project team to help regulators and other stakeholders understand regulatory and safety aspects.

The project team interfaced with many more entities through the course of the project as described in the Acknowledgements and in the References. While this study leverages the expertise of Sandia National Laboratories in terms of hydrogen and fuel cell technologies, the determination of feasibility heavily relied upon first-hand, practical input from all project partners and stakeholders. These conversations took place around the San Francisco Bay, around the country, and around the world. In all cases, the project team strived to make discussions collaborative and two-way. Some of these meetings are highlighted in Figure 2 through Figure 4.



Figure 2: (1) In the engine room of one of RWF's vessels. (2) Visiting Pier 96 at the Port of San Francisco. (3) With the fuel cell mobile light at the Port of Redwood City. (4) At NASA Kennedy Space Center's CryoTest Lab. (5) At Cal State Los Angeles' hydrogen vehicle fueling station. (6) Tour of UC Berkeley's hydrogen vehicle fueling station.



Figure 3: (1) Initial design review meeting at Elliott Bay Design Group. (2) Project kickoff meeting at DOT/MARAD. (3) Regulatory review meeting at ABS including members of the project team and USCG. (4) Regulatory review meeting at USCG Sector San Francisco.



Figure 4: (1) Witnessing Linde’s LH₂ supply operation at AC Transit, Emeryville CA. (2) Visiting the Air Liquide hydrogen fueling station in Paris, France. (3) Touring the Air Products hydrogen fueling station in Allentown PA. (4) Site visit to Praxair’s LH₂ production facility in Ontario, CA.

1.4 Content of the Report

This report is divided into six chapters. Chapter 2 discusses prior work in the general area of clean marine vessels with a focus on zero emissions and hydrogen fuels, and includes both literature studies as well as deployments. Chapter 3 is about the ferry design and includes technical and regulatory aspects. Chapter 4 parallels Chapter 3 but is dedicated to the shore-side hydrogen infrastructure. In Chapter 5 we examine the economic feasibility of the vessel, the hydrogen fueling infrastructure, and the hydrogen fuel itself. Chapter 6 provides a conclusion and suggests recommendations for future work.

2 Background

Fuel cells and hydrogen have been considered for marine vessels for decades. A review by McConnel [15] of the use of fuel cells in maritime applications records 28 demonstration projects since 1964 in the categories of manned and unmanned submarines, yachts, sailboats, research vessels, water taxis, ferries, and recreational boats, with power levels from 30 W to 320 kW.

The bulk of these projects listed by McConnel are primarily accomplished by universities and research groups and are small, experimental demonstrations. There are a few notable exceptions. The largest installation noted by McConnel is a molten carbonate fuel cell installed aboard an offshore supply ship, the *Viking Lady*, which ran for more than 18,500 hours tied in to the LNG-fueled ship's electric propulsion system [16]. Another is work done by the Howaldtswerke-Deutsche Werft (HDW) shipbuilding company, which packages Siemens PEM fuel cells for integration into submarines for air independent propulsion (AIP) systems either during new construction or as a plug-in retrofit [17]. Initial systems consisted of nine 34 kW PEM fuel cells while a newer design uses two 120 kW PEM fuel cells [18]. Hydrogen storage is provided via metal hydride tanks located in the space between the pressure hull and inner hull, offsetting some of the needed ballast. The newer system based on the 120 kW stacks provides an endurance of two weeks [19]. As of 2009, 30 submarines have been using these HDW systems [17].

Other examples of commercial service fuel cell vessels have been low-speed passenger ferries, the *FCS Alsterwasser* in Hamburg, the *NemoH2* in Amsterdam, and the *Hydrogenesis* in Bristol UK. In August 2008 the 100-passenger *FCS Alsterwasser* became the first inland passenger ship in the world to set off under fuel cell propulsion. It sails on the inland lake Alster in Hamburg. It has two 48 kW Proton Motor PEM fuel cells, can achieve 8 knots maximum cruising speed, carries 50 kg of hydrogen stored as a compressed gas at 350 bar (5,000 psi) and typically refuels every 2-3 days [20, 21]. As of October 2012 it had logged over 1900 hours of operation and 7000 miles of travel [22]. Because its hydrogen fueling infrastructure was decommissioned when project funding concluded, it now operates only intermittently on hydrogen.[23]

The *Nemo H2* was described as the world's first canal boat powered by a hydrogen fuel cell. It carried 87 passengers. It was launched in December 2009 [24] and operated for three years with hydrogen supplied in industrial gas cylinders. Its fuel cell power has been cited as between 60-70 kW [25] and it refueled once per day [24]. The trouble and high cost of H₂ gas delivered by this method combined with an inability to site a hydrogen fueling station within a reasonable distance of its route forced the owner to convert the vessel to battery-only power.[26]

The *Hydrogenesis* was designed and built by Bristol Hydrogen Boats, a consortium formed by the directors of Bristol Packet Boat Trips, Number Seven Boat Trips, and Auriga Energy [27]. The ferry is rated to carry 12 passengers and two crew and operates in Bristol Harbor (UK). It is powered by four Auriga Energy air-cooled fuel cells delivering up to 12kW continuous power at 48V.[28] It appears to have started with a single 350 bar gaseous hydrogen tank with hydrogen initially supplied by an Air Products mobile refueler for the project's 6-month demonstration in 2013.[28, 29] Following the demonstration period, it appears the hydrogen fueling station was decommissioned but that the boat

continues to run on a charter basis using hydrogen supplied by industrial gas bottles.[30, 31] The vessel now appears to be for sale at an asking price of £67,000.[31]

The “e4ships” project in Germany is currently in progress (as of May 2016) and has three components. Toplaterne is the “strategy module” which is an analysis piece around fuel cell systems in technical, economic, and regulatory aspects. Pa-X-ell is a demonstration project which plans to install a 30 kW high temperature (HT)-PEM fueled by methanol on board a cruise ship to feed into the ship’s electrical system. SchIBZ plans to install a 100 kW SOFC in a hybrid configuration with low sulfur diesel as the fuel. Unfortunately neither demonstration project considers zero emission hydrogen power. More information can be found through Ref. [32]

Several studies have examined the factors influencing introduction of fuel cells for vessels. A Det Norske Veritas (DNV) report [33] gives three main reasons for limited use to-date: first and foremost is the cost of the fuel cell, and the others are the limited products tailored to the maritime market and the limited availability of hydrogen and LNG. A prior study [34] commissioned by the U.S. Coast Guard examined the potential for fuel cells providing either propulsion or auxiliary power, applied to vessel types representing nearly all (93%) of vessels in the world. It concluded that the most attractive market segment is commercial marine vessels where electric propulsion is already economically viable, and noted that the largest barriers to fuel cells entering this market are lack of a broad fueling infrastructure, poor operating characteristics (i.e., response time), short demonstrated life, and uncertain maintenance schedules. While the first issue remains a challenge today as evidenced by the fates of the three European hydrogen ferries (*Alsterwasser*, *Nemo H2*, and *Hydrogenesis* were all thwarted by a lack of fueling infrastructure), the latter issues have been enormously improved upon in the last 15+ years of fuel cell development.

The US Navy’s Naval Surface Warfare Center, Carderock Division has conceptualized a LH₂-fueled gas turbine power plant for a high speed (55 knot) cargo vessel. In this concept, the vessel has 175 MW of gas turbine power installed and a range of 9,000 nm with 1,820 metric tons of LH₂ fuel [35]. There is no other published data on this concept.

The literature contains several evaluations of fuel cell systems that utilize existing on-board hydrocarbon fuels, and as such are not zero emission. Presumably there is an assumption that the logistical benefit of continuing to use current fuels outweighs the drawbacks of continued GHG emissions. Indeed, unless there is any kind of regulatory incentive to decarbonize marine fuels, this seems a practical conclusion. Sun et al. [36] examined a solid oxide fuel cell – gas turbine hybrid implemented on a military sealift vessel. It assumes use of very low sulfur diesel and constrains the study to an existing platform and even an existing engine room size. The study acknowledges that current SOFC technology does not have the power density to fulfill the power requirements with the weight constraint and bases the configuration on a fuel cell that is assumed to be developed in 15-20 years. A follow-on study by Naval Surface Warfare Center Carderock Division [37] examined a wider array of potential fuel cell systems on US Navy vessels, but also limited its scope to current liquid hydrocarbon fuels. The conclusions therefore favor higher temperature fuel cells in hybrid configurations largely due to the extensive on-board fuel processing required to generate hydrogen from hydrocarbon fuels for low temperature fuel

cells. It also assumed integration of fuel cells into an existing vessel rather than a ground-up design of a new vessel. This resulted in the suggestion to remove approximately 10% of the fuel because of the additional weight or reduce the weight of the ship in another way, presumably to maintain performance targets.

Lastly it should be noted that an alternative to fuel cells for achieving zero emissions power is a battery-only system. Battery electric zero emission vessels have been commercially viable, especially in smaller, low-power vessels. In an impressive step forward, the first battery electric car and passenger ferry entered service in Norway in late 2015. The Norled's *Ampere* carries up to 360 passengers and 120 vehicles, and travels across a fjord 6 km (3.2 nm) each direction at an average speed of 10-12 knots, powered by two 450 kW motors. It plugs in at the end of each one-way trip in order to maintain charge on its internal batteries. It is estimated that there are at least 50 other routes in Norway that can be serviced with this kind of configuration. (Information about the *Ampere* from Reference [38].)

While small and slow zero emission hydrogen fuel cell vessels have been demonstrated, the largest zero emission vessel is battery electric. However, it also operates at a low speed and has a short route on which it "refuels" after every one-way trip. There is a gap in the knowledge base about faster, larger, and longer endurance zero emission vessels, with Carderock's conceptual high speed cargo ship at the extreme far end of the design space. In the United States, more than half of the ferries operated at over 10 knots and had 150 passengers or more [39]. Therefore there is a need for detailed examination of zero emission hydrogen vessels that operate at higher speeds and carry more passengers than existing fuel cell vessels, which is one objective of the study reported here.

3 Ferry

This chapter describes the assessment of the SF-BREEZE ferry from a technical, regulatory, and economic point of view. An integral part of this chapter is the design package completed by Elliott Bay Design Group, which is included in its entirety in Appendix A.

3.1 Technical Assessment

This section examines the technical aspects of the SF-BREEZE ferry. The technical feasibility determination centered around finding whether a zero emission passenger ferry could be designed, built, and operated while meeting the performance and regulatory requirements.

3.1.1 Performance requirements

The SF-BREEZE is a conceptual high-speed hydrogen fuel cell ferry designed for commercial use on the San Francisco Bay.

The existing Vallejo to San Francisco route was chosen for the maritime mission. This route is shown in Figure 5, with detailed information given in Figure 6 and Table 1. The Vallejo to San Francisco route involves passenger loading at the Vallejo Ferry Terminal, maneuvering the vessel away from the Vallejo Terminal within the Mare Island Channel, navigation at slow speeds through the Mare Island Channel, high speed crossing on the open San Francisco Bay, maneuvering at the Port of San Francisco Ferry Building Terminal, and passenger unloading. Figure 6 gives the trip profile (speed vs. time) for the

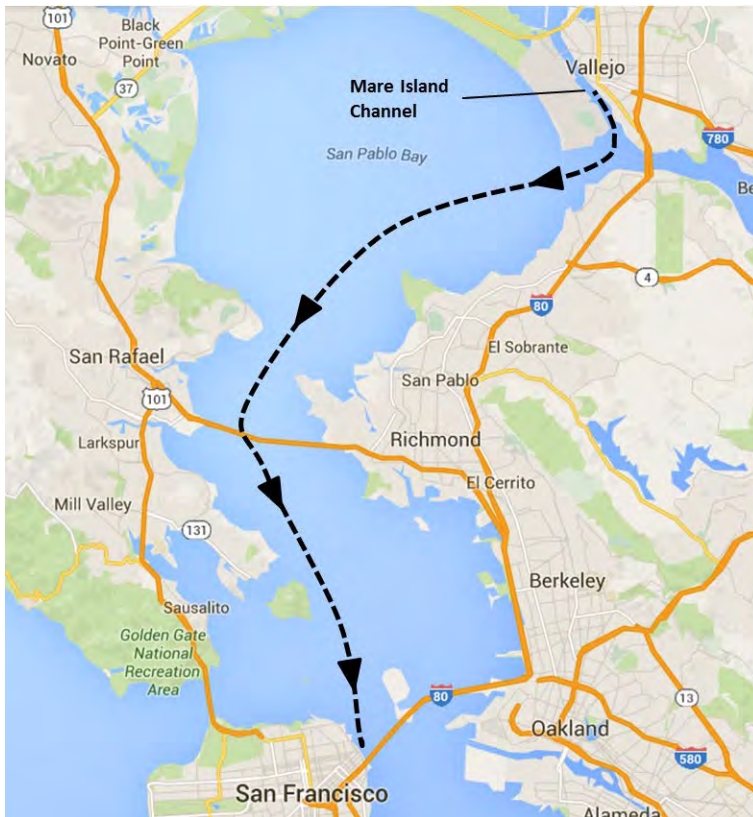

Figure 5: Existing ferry route for the *Vallejo*, providing ferry service between Vallejo, CA and San Francisco, CA.

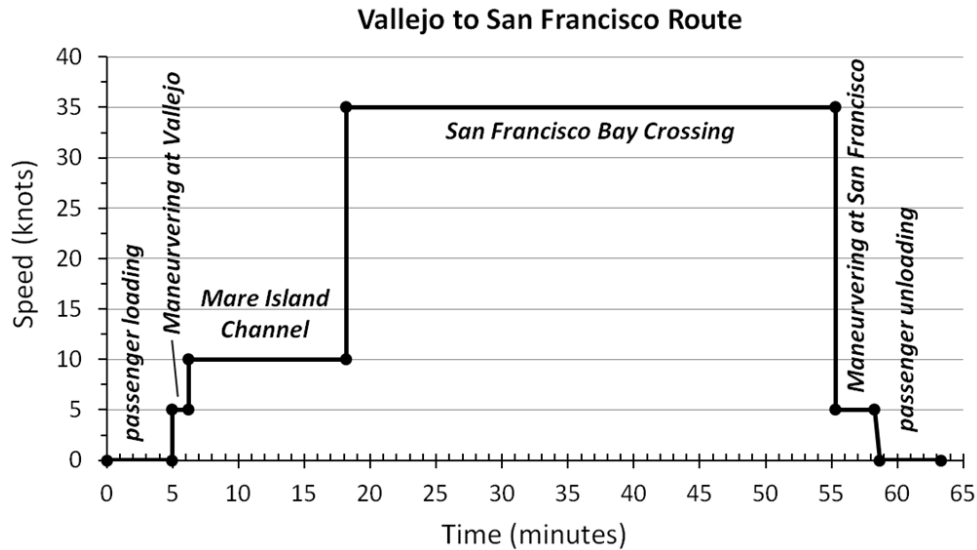

Figure 6: Route profile (speed versus time) for a one-way trip from the Vallejo, CA Ferry Terminal to the San Francisco Ferry Building Terminal onboard the *Vallejo* Ferry.

existing Vallejo-SF ferry service, while Table 1 gives additional information on the distances involved.

The Vallejo to San Francisco route was chosen to provide a stiff challenge to the fuel cell ferry design. First, the existing service requires a top speed of 35 knots, determined for commercial reasons to be competitive with other modes of transport in the Bay Area. Second, the route is 24 nautical miles long, the longest ferry route currently in service on the bay, which places demands on the SF-BREEZE design range and sets a high bar for feasibility in terms of endurance that would also satisfy shorter routes. An additional benefit of using this route for the maritime mission is that detailed information (step duration, speed) is available for this route, which formed the basis for Figure 6 and Table 1.

Table 1: Vallejo to San Francisco Ferry Route Details. Step Distance (in nautical miles, nm), Cumulative Distance, Step Speed, Step Duration and Cumulative Time for a one-way trip onboard the *Vallejo* from the Vallejo Ferry Terminal in Vallejo, CA to the San Francisco Ferry Building Terminal in San Francisco, CA.

	Passenger Loading	Maneuvering at Vallejo	Mare Island	SF Bay Crossing	Maneuvering at SF	Passenger Unloading
Step Distance (nm)	0	0.1	2.0	21.65	0.25	0
Cumulative Distance (nm)	0	0.1	2.1	23.75	24	24
Speed (knots)	0	5	10	35	5	0
Step Duration (mins)	5	1.2	12	37.1	3	5
Cumulative Time (mins)	5	6.2	18.2	55.3	58.3	63.3

3.1.2 Power Plant Selection

The purpose of the SF-BREEZE is to eliminate GHG and criteria pollutant emissions (NO_x, SO_x, PM) from current diesel-fueled ferries by introducing hydrogen fuel cell technology into high-speed ferry service. There are a number of different types of fuel cells that can be considered for this application. We begin by briefly reviewing fuel-cell power systems in general.

An excellent review of fuel cell systems can be found in Reference [40]. A fuel cell provides, in an electrochemical environment, a way to combine gaseous hydrogen and oxygen to form water (typically water vapor), as indicated by:

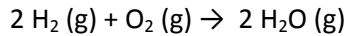

Sometimes hydrogen is used directly. Other times, natural gas (NG) is fed to the fuel cell and the NG is internally “reformed” to hydrogen. The hydrogen fuel is not burned. Rather, the reaction proceeds electrochemically, producing electrical energy and waste heat.

The thermal efficiency of the electrochemical process can be significantly higher than traditional internal combustion engines (ICEs), due to engine materials limits to the temperature at which combustion can be conducted. However, in the absence of such limits, both ICEs and fuel cells have equivalent thermal efficiencies.[40-42] Whereas traditional gasoline combustion has a thermal efficiency of ~35%, limited by the temperatures achievable in traditional combustion systems, the thermal efficiency of the electrochemical process can exceed ~ 50%. Thus, 50% of the energy released by the reaction above can be converted to electricity, with the remaining 50% constituting “waste heat” which is removed from the system by cooling air or liquid. In “combined cycle” fuel cell systems, this waste heat can be captured and used, which would increase the effective fuel cell system thermal efficiency beyond 50%.

The efficiency of the electrochemical process can be significantly higher than traditional combustion. Lutz et al. [41] have compared conventional H₂/O₂ combustion with the “electrochemical combustion” provided in a fuel cell. Whereas traditional combustion has a thermal efficiency of ~35%, limited primarily by the temperatures achievable in traditional combustion systems, the thermal efficiency of the electrochemical process can be ~ 50%. Wright [42] has also compared fuel cell efficiency with that of heat engines.

All fuel cells have the same overall geometric structure indicated in Figure 7. “Fuel”, either hydrogen or NG (mostly methane, CH₄), is fed to the anode side of the fuel cell where oxidation (electron removal) takes place. Oxygen (typically from air) is fed to the cathode side, where reduction (electron attachment) takes place. An intervening electrolyte allows a mobility ion to complete the circuit. Electrons flow through the Load, driven by the electromotive force of the two half-reactions occurring on the anode and cathode. Fuel cells are not 100% efficient, so some fuel energy is spent heating up the fuel cell as waste heat. Fuel cells running on pure hydrogen release only H₂O as a product, as indicated by the equation above. If NG (methane) is used, then CO₂ is also released.

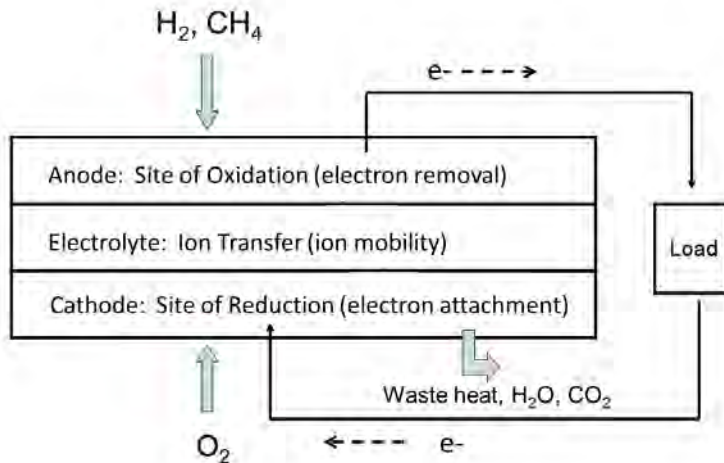

Figure 7: General diagram of a fuel cell, reproduced with modification from Reference [40].

3.1.2.1 Types of Fuel Cells and Selection

Over the years, there have emerged five general classes of fuel cell systems, which to varying degrees are commercially available. Table 2 lists these five types, as reported in Reference [40].

The fuel cell types can be divided into two regimes of operating temperature: low-temperature fuel cells that operate in the range 50°C to 220°C (proton exchange membrane, alkaline, and phosphoric acid fuel cells), and high-temperature fuel cells that operate above 650°C (molten carbonate, and solid oxide fuel cells). Although high-temperature fuel cells are undesirable because it can take hours to heat up large units, we will examine them for their gravimetric and volumetric power density, and assess them for market track record.

We will discuss the fuel cells in terms of two power specifications (specs). The gravimetric power spec is defined as:

$$\text{Gravimetric Power Spec} = [\text{Output Power}]/[\text{Fuel Cell Mass}] \text{ (kW/kg)}$$

The volumetric power spec is defined as:

$$\text{Volumetric Power Spec} = [\text{Output Power}]/[\text{Fuel Cell Volume}] \text{ (kW/m}^3\text{)}$$

Table 2: Types of Fuel Cells, from Ref. [40]

Fuel Cell Type	Electrolyte Mobile Ion	Operating Temperature
Proton exchange membrane (PEM)	H ⁺	50 – 100 °C
Alkaline (AFC)	OH ⁻	50 – 200 °C
Phosphoric Acid	H ⁺	~220 °C
Molten Carbonate	CO ₂ ³⁻	~650 °C
Solid Oxide	O ²⁻	500 – 1000 °C

Ideally, one would like a gravimetric spec of infinity, as we want maximal output power for minimal fuel cell mass. Similarly, we want the volumetric power spec to be as large as possible to maximize power production within the limited space onboard a high-speed ferry.

In principle, one should really compare the gravimetric and volumetric specs of the fuel cell system, where the system is comprised of the power plant plus all hardware associated with providing fuel to the fuel cell. However, for simplicity, and because some fuel cells have highly undesirable properties (such as GHG emissions) which eliminate them from further consideration, we will restrict the analysis to the fuel cell power plants themselves.

3.1.2.1.1 Solid Oxide Fuel Cells:

Solid oxide fuel cells (SOFCs) are commercially available units fueled by NG. Bloom Energy is the primary commercial manufacturer of SOFCs in the ~ 200 kW range [43]. There are no commercially available solid oxide fuel cells that run on hydrogen. As a result, SOFCs emit CO₂ when run on fossil-based natural gas. Operation on biogas would reduce the GHG emissions considerably. A picture of an array of Bloom Energy ES-5700 210kW solid oxide fuel cells is shown in Figure 8.

The ES-5700 has dimensions 8.05 m x 2.62 m x 2.06 m, with a total volume of 43.45 m³ [43]. The mass of the fuel cell is 17,600 kg. Thus, the gravimetric power spec is 210 kW/17,600 kg = 0.0119 kW/kg. The volumetric power spec is 210 kW/43.45 m³ = 4.83 kW/m³. The ES-5700 is rated to emit ~ 360 kg of CO₂/MWh when fueled with fossil NG.

Since the temperature of SOFC is a very high, 500 -1000 °C, the ES-5700 takes ~ 5 hours to fully warm up to begin producing power. More importantly, cycling SOFCs on and off will reduce their lifetime and affects long term durability. The long warm-up times are inconsistent with ferry operation that requires power to be immediately available. The only way around this would be to keep the SOFC power plant at temperature all the time, which would be inefficient. Due to large CO₂ emissions and prohibitive warm up times, SOFC technology is not suitable for the SF-BREEZE. In addition, commercially available, large scale SOFC technology has not demonstrated an ability to run on pure hydrogen.

3.1.2.1.2 Molten Carbonate Fuel Cells

Molten Carbonate fuel cells (MCFCs) are commercially available that run on natural gas. Fuel Cell Energy is the primary commercial supplier of molten carbonate fuel cells in the ~ 200 kW range and above [44].



Figure 8: Bloom Energy ES-5700 solid oxide fuel cells, each producing power at 210 kW each. Photo from Reference [43].



Figure 9: Fuel Cell Energy DFC300 MCFC power plant. Photo from Reference [44].

Like SOFCs, there are no commercially available MCFCs that have been demonstrated to operate on pure hydrogen. As a result, MCFCs emit CO₂, which is inconsistent with the zero-emission design philosophy of the SF-BREEZE. Fuel Cell Energy makes a DFC300 300 kW fuel cell, a picture of which is shown in Figure 9.

The DFC300 Fuel Cell Module has dimensions $\sim 3.0 \text{ m} \times 3.0 \text{ m} \times 3.6 \text{ m} = 32.40 \text{ m}^3$ [44]. The mass of the fuel cell module is 15,909 kg. Thus, the gravimetric power spec is $300 \text{ kW}/15,909 \text{ kg} = 0.0188 \text{ kW/kg}$. The volumetric power spec is $300 \text{ kW}/32.40 \text{ m}^3 = 9.26 \text{ kW/m}^3$. Note that this volumetric power density is for the fuel cell power unit only, with the mechanical and electrical balance of plants housed in separate units. The DFC300 is rated to emit 445 kg of CO₂/MWh when run on fossil-based NG.

From a cold start, the DFC 300 can take almost 72 hours to fully warm up and suffers the same need to avoid start-stops like the SOFC. From this standpoint, the unit is incompatible with the on-demand power required for ferry operation, as described above for the SOFC. In addition, due to large CO₂ emissions when the MCFC is run on natural gas, the unit is inconsistent with the zero-emissions philosophy of the SF-BREEZE.

3.1.2.1.3 Phosphoric Acid Fuel Cell (PAFCs)

PAFCs are commercially available that are fueled by natural gas. Doosan is the primary commercial manufacturer of PAFCs [45][6], with the Doosan PureCell Model 400 providing 440 kW. Discussions with Tim Patterson at Doosan [46] revealed that this Doosan fuel cell has no track record running on hydrogen because there has not been a market for it. Also, the warm-up time is of order 4 – 6 hours. The PAFC reaction has sluggish kinetics, which reduces the rated power compared to PEM fuel cells (to be discussed) [46]. Since the unit runs on natural gas, it releases CO₂ when running. The CO₂ emission rating is 477 kg /MWh when operated on fossil-based NG. A picture of Doosan PureCell Model 400 440kW PAFC is shown in Figure 10.



Figure 10: Doosan 440 kW PureCell Model 400 PAFC. Photo from Reference [45].

The PureCell Model 400 power module has dimensions 8.74 m x 2.54 m x 3.02 m, with a total volume of 67.04 m³ [45]. The mass of the fuel cell module is 27,216 kg. Thus, the gravimetric power spec is 440 kW/27,216 kg = 0.0162 kW/kg. The volumetric power spec is 440 kW/67.04 m³ = 6.56 kW/m³.

Since the warm-up time for the Doosan PureCell Model 400 is 4 - 6 hours, the unit is incompatible with the on-demand power required for ferry operation, as described above for the SOFC. In addition, due to CO₂ emissions when the PAFC is run on natural gas, the unit is inconsistent with the zero-emissions philosophy of the SF-BREEZE.

There has been some R&D to investigate a PAFC running on pure hydrogen. Kuroda from Fuji Electric in Japan reports [47] the development of 105 kW PAFC running on pure hydrogen, eliminating the NG reforming equipment that is normally on PAFC units. A picture of the Fuji Electric unit is shown in Figure 11, in operation powering a museum.

The Fuji Electric PAFC has dimensions 5.6 m x 2.2 m x 3.4 m, with a total volume of 41.88 m³ [47]. The mass of the fuel cell module is 12,700 kg. Thus, the gravimetric power spec is 105 kW/12,700 kg = 0.00827 kW/kg. The volumetric power spec is 105 kW/41.88 m³ = 2.51 kW/m³. Presumably, there is still a significant warm-up time to achieve the ~ 200 °C operation, but this was not reported in Kuroda's presentation [47], or the article that followed [48].



Figure 11: Fuji Electric 105 kW, Model FP-100i PAFC. Photo from Reference [47].

3.1.2.1.4 Alkaline Fuel Cell (AFCs)

AFC designs have been described since 1902, and were developed throughout the 1940s and 1950s. AFCs run on pure hydrogen, and are a low-temperature fuel cell. As indicated in Table 2, hydroxide ion (OH^-) is the mobile electrolyte ion. During the 1960s, the AFC provided electrical power to the Apollo moon missions [40] due to the immaturity of Proton Exchange Membrane fuel cell materials at the time. The disadvantages of the AFC for mobility applications are that a separate solution of >25 wt% KOH must be supplied to the fuel cell stack and ceramic pumps must be used to move the corrosive KOH electrolyte through the system. In addition, CO_2 must be kept out of the system in order to avoid the loss of electrolyte. Potassium hydroxide will react with CO_2 to form potassium carbonate (K_2CO_3), leading to a loss in power output. Managing the flow and containment of highly corrosive KOH is a severe logistical issue for AFC systems. While AFC fuel cells are a well-proven technology, they are more complicated and heavier than PEM based fuel cell stack systems. With advances in the technology of PEM fuel cells, R&D in AFCs has decreased dramatically. They are currently inferior to PEM fuel cell technology for the SF-BREEZE application and are not commercially available at the power scale needed by the SF-BREEZE.

3.1.2.1.5 Proton Exchange Membrane (PEM) Fuel Cells

PEM fuel cells are the fastest growing fuel cell technology, due to its development and application for mobility power (i.e. fuel cell vehicles). Figure 12 shows the relevant reactions in a PEM fuel cell. At the PEM anode (site of oxidation) hydrogen gas ionizes (oxidizes), releasing electrons to the external circuit and protons to the membrane. Simultaneously, at the cathode (site of reduction), oxygen molecules are reduced by the electrons from the circuit, and join with protons (having traversed the membrane) to form water molecules.

Commercial fuel cell units consist of “stacks” of the fundamental PEM fuel cell unit shown in Figure 1. The PEM fuel cell generates electricity with a thermal efficiency (electrical work out/fuel energy in) of

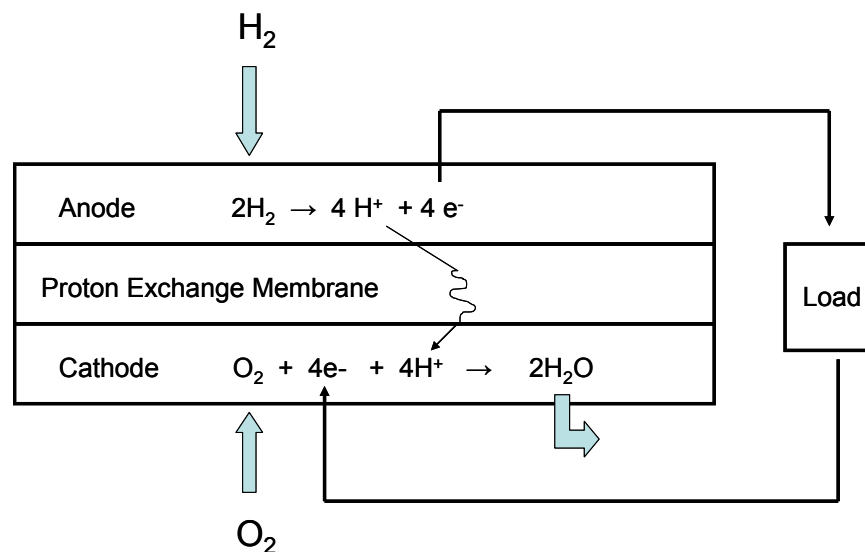

Figure 12: Schematic Diagram of a Proton Exchange Membrane (PEM) Fuel Cell.

~41 – 53%, depending on the load. It uses pure hydrogen (typically > 99.95% pure) at the anode, and can operate at relatively low temperatures (50 – 100 °C), using a catalyst (typically platinum) to increase the reaction kinetics. PEM fuel cells are dramatically quieter than internal combustion engine (ICE) technology.[14] Since there is no combustion occurring in the fuel cell and the fuel is pure hydrogen, there is zero NO_x emission, zero SO_x, zero hydrocarbons (HC) and zero particulate emission. The PEM fuel cell is certified as a zero-emissions power system by the California ARB. The PEM fuel cell offers high power density, high efficiency, the potential for good cold and transient performance and is amongst the lightest and most compact of fuel cells. Furthermore, the PEM fuel cell is commercially available with an excellent performance track record. These advantages, combined with it being a zero-emission source, made the PEM fuel cell the hydrogen engine of choice for the SF-BREEZE.

PEM fuel cells deliver high power density and offer lighter weight and smaller volume than other fuel cell systems because they have been specifically developed for lower-scale mobility power applications such as vehicle power plants, and auxiliary power. Traditional PEM fuel cells use a solid proton conducting polymer membrane called Nafion, a polyfluorinated sulfonic acid (PFSA) material, which facilitates proton transfer between the anode and cathode. Porous carbon electrodes containing a platinum catalyst act as the metal electrode assemblies (MEAs). PEM fuel cells require only hydrogen and oxygen to operate.

Nafion-based fuel cells operate at low temperatures, around 60°C to 80°C. The low-temperature operation provides for rapid start-up and certain architectures provide unlimited start-stop cycles with no added degradation, both of which are essential for the SF-BREEZE high-speed ferry application. The MEAs in PEM fuel cells require a Pt catalyst, which is sensitive to CO poisoning. However, for the SF-BREEZE, LH₂ will be used, which is a very pure (99.999% pure) form of hydrogen. As a result of their application in many other mobility applications, PEM fuel cells are also insensitive to the rocking motions, vibrations, and shocks that can be found on-board maritime vessels.

There are two major manufacturers of commercially available PEM fuel cells in the 30 – 100 kW range, Ballard Power Systems and Hydrogenics, Inc. Automakers are also manufacturing PEM fuel cells in this size range but those units are not available for separate purchase.

Ballard Power Systems Inc. manufactures a number of PEM fuel cells. The FC Velocity HD 90kW fuel cell is shown in Figure 13.

The Ballard 90 kW HD power module has dimensions 1.13 m x 0.869 m x 0.506 m, with a total volume of 0.497 m³ (from Ballard's website⁹). The mass of the fuel cell module is 256 kg. Thus, the gravimetric power spec is 0.352 kW/kg. The volumetric power spec is 181.1 kW/m³. Ballard was unresponsive to requests for additional information about their products beyond what is shown on their website.

⁹ <http://ballard.com/>



Figure 13: Ballard 90 kW FC Velocity HD PEM fuel cell. Photo from Ballard’s website.

Hydrogenics manufactures a “building block” 33 kW PEM fuel cell, the model HyPM HD30. This fuel cell is shown in Figure 14. Ryan Sookhoo of Hydrogenics provided critical detail about their PEM fuel cell offerings, information which was required to assess the technical feasibility of the SF-BREEZE [49].

The HyPM HD30 PEM fuel cell has dimensions 0.668 m x 0.406 m x 0.215 m, with a total volume of 0.0583 m³ [50]. The mass of the fuel cell module is 73.6 kg. Thus, the gravimetric power spec is 0.448 kW/kg. The volumetric power spec is 566.0 kW/m³. The Hydrogenics HyPM HD 30 also forms the basis of higher power fuel cell racks, as depicted in Figure 15. Combining individual fuel cell stacks into a power rack degrades the gravimetric and power specs because of the required frame and additional balance of plant. Using the dimensions and mass for the Fuel Cell Power Rack shown in Figure 15, the gravimetric power spec is 0.150 kW/kg, and the volumetric power spec is 73.97 kW/m³.

Table 3 lists the gravimetric and volumetric power specs for the fuel cell systems we have examined thus far. It is clear that the PEM fuel cell has the best gravimetric power and volumetric specs of the different fuel cell types. This is a consequence of the PEM fuel cell being developed for mobility applications which stress high power systems in the lightest weight and smallest footprint possible. In addition, lower-temperature operation, combined with lightweight proton exchange membranes, promote smaller and lighter fuel cell stacks. Of the PEM fuel cells commercially available in this power range, the Hydrogenics units provide the highest gravimetric and volumetric densities. Because of this



Figure 14: Hydrogenics 33 kW HyPM HD30 PEM fuel cell. Photo from Reference [50].

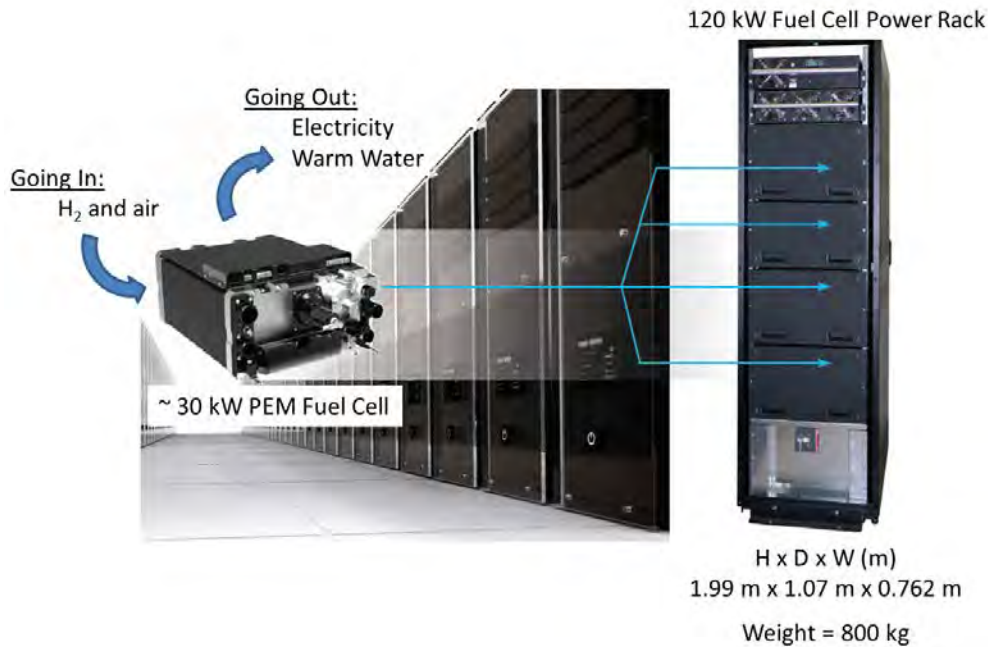

Figure 15: Assembly of four Hydrogenics HyPM HD30 PEM fuel cell into a fuel cell power rack. Background photos courtesy of Ryan Sookhoo, Hydrogenics [49].

Table 3: Gravimetric and volumetric specs for the fuel cell technologies discussed.

Type of Fuel Cell	Gravimetric Power Spec (kW/kg)	Volumetric Power Spec (kW/m ³)	Manufacturer, Model
210 kW SOFC (NG fueled)	0.0119	4.83	Bloom Energy, Model ES-5700
300 kW MCFC (NG fueled)	0.0188	9.26	Fuel Cell Energy, Model DFC300
440 kW PAFC (NG fueled)	0.0162	6.56	Doosan, Model PureCell 400
105 kW PAFC (H ₂ fueled)	0.00827	2.51	Fuji Electric, Model FP-100i
90 kW PEM (H ₂ fueled)	0.352	181.0	Ballard, Model FC Velocity HD
33 kW PEM (H ₂ fueled)	0.448	566.0	Hydrogenics, Model HyPM HD 30
120 kW Power Rack (H ₂ fueled)	0.150	73.97	Hydrogenics, Power Rack Based on 4 HyPM HD 30 fuel cells

performance and the amount of commercial and technical information available from Hydrogenics personnel, the Hydrogenics PEM technology was used as the basis for the initial design of the SF-BREEZE.

3.1.2.2 Comparison with Battery Technology

The Hydrogenics 120 kW PEM Power Rack is the basis for power on the SF-BREEZE. The SF-BREEZE employs 41 of the Hydrogenics 120 kW fuel cell racks. It uses pure hydrogen, which is becoming increasingly more available as hydrogen stations serving fuel-cell vehicles are coming into existence. As such, the SF-BREEZE is making use of a fuel that will be coming to market in increasing amounts in the next few years.

We ask the question: how does the LH₂/Fuel Cell system of the SF-BREEZE compare to an analogous battery-based system? A battery stores both the energy and the electrochemical conversion hardware all in the same device and has zero emissions at the point of use. Thus, to compare to a battery, we must calculate the total energy that is delivered by the LH₂/fuel cell system, the total system mass (fuel cell + LH₂ storage + evaporator) and total system volume (fuel cell + LH₂ storage + evaporator).

In the design of the SF-BREEZE to this point, we have 41 120-kW PEM fuel cell power racks, combined with 1200 kg of LH₂ stored in a cryogenic tank. An evaporator converts the LH₂ to room temperature hydrogen. The cryogenic tank filled with 1200 kg of LH₂ will have a mass of 11,640 kg. The LHV of hydrogen is 119.96 MJ/kg. Thus, the stored energy is 1200 kg x 119.96 MJ/kg = 143,952 MJ. The Hydrogenics HyPM 30 fuel cell efficiency is for most loads ~ 53%. Thus, the deliverable energy is 0.53 x (143,952 MJ) = 76,294 MJ.

The total mass of the SF-BREEZE LH₂/fuel cell system is 11,640 kg (LH₂ tank) + 32,000 kg (Fuel Cell Power Racks) + 907 (evaporator) = 44,547 kg. The total volume of the SF-BREEZE LH₂/fuel cell system is 29.76 m³ (LH₂ tank) + 64.88 m³ (fuel cells) + 1.73 m³ (evaporator) = 96.37 m³.

Therefore, the deliverable gravimetric energy density from the SF-BREEZE LH₂/fuel cell system is 76,294 MJ/44,547 kg = 1.71 MJ/kg. The deliverable volumetric energy density is 76,294 MJ/96.37 m³ = 791.6 MJ/m³.

Batteries are typically operated to release ~ 50% of their stored charge so as to avoid damage from deep discharge. However, for this comparison, we will assume a battery discharge of 80% of its stored energy. Thus, to deliver 76,294 MJ of energy, the battery must store 76,294 MJ/0.8 = 95367.5 MJ of energy. For the battery system, we compare to the lightest battery system specification we could identify. This is the battery pack used in the Tesla Model S 85 electric vehicle¹⁰. Although not a marine battery, and not commercially available separately from the vehicle, it was chosen to give a best-case scenario as batteries from Spears, SAFT, and Corvus were also considered but were heavier. One Tesla battery pack holds 85 kW-hr (306 MJ) of energy, is estimated to have a mass of 540 kg and has a volume between 0.1175 m³ and 0.15m³. To deliver 95367.5 MJ of energy, we need 311.65 of these battery packs. These

¹⁰ The exact battery specs for the Tesla Model S are likely proprietary and any public description of it is approximate only.

combined battery packs will have a mass of 168,291 kg and have a total volume of 36.6 m³ using the favorable per-pack volume of 0.1175 m³.

Therefore, the deliverable gravimetric energy density from the Tesla battery pack is 95367.5 MJ/168291 kg = 0.566 MJ/kg. The deliverable volumetric energy density is 95367.5 MJ/36.6 m³ = 2605.6 MJ/m³.

The best-case battery system (based on the Tesla) has a superior deliverable volumetric storage density (2605.6 MJ/m³) compared to the LH₂/fuel cell system (791.6 MJ/m³), although it should be noted that existing marine batteries are 8-30 times larger. However, there is a dramatic weight disadvantage for the battery system. The battery system has a deliverable gravimetric energy density of 0.566 MJ/kg, 3 times worse than the 1.71 MJ/kg value of the SF-BREEZE LH₂/fuel cell system. Since the high-speed ferry is a very weight-sensitive application (refer to Section 3.1.4.4), hydrogen PEM fuel cell technology is preferred over the best-possible available battery-based system for the power and energy requirements of the SF-BREEZE.

3.1.2.3 Summary of Powerplant Selection

Table 4 summarizes the various powerplant options available for the SF-BREEZE. As the SF-BREEZE is a zero emissions ferry at the point of use, we require the point of use GHG emissions to be zero. Furthermore, we require any candidate power plant to be commercially available with a solid track record of use. Finally the power plant has to be technically capable and competitive meeting the 35-knot high speed target.

We see from Table 4 that current engines based on diesel combustion, NG combustion, or hybridized versions of these technologies release CO₂ and are thus not in support of the zero emissions goals of the

Table 4: Summary of candidate power plants for a high-speed ferry. The compatibility of a technology with the SF-BREEZE objectives is indicated with a check or X mark. A red X signifies “No,” a green check signifies “Yes.”

Power Plant (Engine)	Technically Viable for SF-Breeze	Commercial Product	Zero Emission
Diesel Combustion	✓	✓	✗
LNG/Natural Gas Combustion	✓	✓	✗
Combustion-Electric Hybrid	✓	✓	✗
Fuel Cells (fuel)			
• Solid Oxide (NG)	✗	✓	✗
• Molten Carbonate (NG)	✗	✓	✗
• Phosphoric Acid (NG, H ₂)	✗	✓	✗, ✓
• Alkaline (H ₂)	✗	✗	✓
• PEM (H ₂)	✓	✓	✓
Battery Electric	✗	✓	✓

SF-BREEZE. Any fuel cell using NG as a fuel (Solid Oxide, Molten Carbonate, Phosphoric Acid) also release CO₂, again in consistent with the zero emissions goal. A PAFC running on pure hydrogen would be compliant with zero emissions, but the PAFC technology is too heavy. The SOFC, MCFC and PAFC technologies are all too heavy for the SF-BREEZE application and these high temperature fuel cells suffer from limited start and stop performance. Alkaline fuel cells would also be too heavy and in any event are not commercially available. A Battery Electric vessel would be zero emissions at the point of use, and the battery engine is commercially available. However, Battery Electric operation is too heavy to support the 35-knot SF-BREEZE mission. Of all the technologies listed in Table 4, only PEM fuel cell technology can meet the combined requirements of the SF-BREEZE.

3.1.3 Hydrogen Storage Selection

The SF-BREEZE is a hydrogen-fueled high-speed ferry using PEM fuel cell technology. The task of the hydrogen storage system is to hold as much hydrogen as required by the energy utilization profile of the vessel within the desired refueling schedule.

The GHG emissions part of this report (Section 3.1.5) describes in detail the energy needed to perform the “Vallejo to San Francisco” mission. Since in the early days of SF-BREEZE operation, there will not be many hydrogen stations available to refuel, we have not analyzed in detail the scenario where the SF-BREEZE refuels at every passenger embarkation or dis-embarkation point. Such a scenario, allowing the refueling of only enough hydrogen for a one way trip (198.4 kg), allows a minimum hydrogen storage capacity. This would actually be desirable in many respects, as it would minimize the required weight and volume of the hydrogen storage system. However, the current scarcity of hydrogen stations would not permit this scenario in initial SF-BREEZE operation, so we don’t consider it further.

Instead, we consider the scenario where the SF-BREEZE holds enough hydrogen to make two round trips from Vallejo to San Francisco. The scenario is that the SF-BREEZE would make two round trips between Vallejo and San Francisco in the morning, refuel at noon, make another two full round trips in the afternoon, and refuel again in the evening. This refueling schedule and route requires the storage of ~ 1000 -1200 kg of hydrogen onboard the SF-BREEZE.

There are three ways of storing hydrogen: as a high-pressure gas, within a compound or chemical host that can store and release hydrogen, or as a cryogenic liquid. Each storage method has different weights and volumes, and for an application such as the SF-BREEZE both of these characteristics are critical in understanding whether a storage system is feasible. To aid in evaluation there are two quantities that can be used to compare the different storage methods.

One is the storage system gravimetric specification (“spec”), defined as:

$$\text{Gravimetric Spec} = [\text{Empty Tank Mass (kg)}]/[\text{Mass of Stored Hydrogen (kg)}].$$

An ideal storage system would have a value of zero for the gravimetric spec. Similarly, one can define a volumetric storage specification as:

$$\text{Volumetric Spec} = [\text{Outer Tank Volume (L)}]/[\text{Mass of Stored Hydrogen (kg)}].$$

Table 5: Gravimetric and Volumetric Storage Specifications (specs) for the hydrogen storage methods discussed. See the text for definitions of the storage specs.

Tank	Gravimetric Spec (Empty Tank Mass/H ₂ Stored Mass) (kg/kg)	Volumetric Spec (Outer Tank Volume/H ₂ Stored Mass) (L/kg)	Source
2200 psi, carbon steel	103.4	105.7	Matheson, 2015
2015 psi, aluminum	72.37	130.0	Matheson, 2015
5,000 psi, composite	19.44	65.31	Lincoln, 2007
5,000 psi composite	17.92	54.91	Luxfer, W320H, 2015
5,000 psi gas only (for reference)	0	43.4	
7,000 psi, composite	16.21	49.69	Lincoln, 2007
10,000 psi composite	23.50	42.12	Lincoln, 2007
10,000 psi composite	23.88	48.41	Luxfer, 2015
10,000 psi gas only (for reference)	0	25.6	
Pod Assembly (5,000 psi)	18.57	125.45	Pod Assembled from Luxfer W320H tanks
Ovonic Metal Hydride Tank	63.0	23.63	Data from Ovonic Prototype, 2010
LH ₂ Tank	8.7	24.8	Gardner Cryogenics

An ideal storage system volumetric spec would be hydrogen’s gas density at the pressure and temperature of the storage. Table 5 captures the gravimetric and volumetric specs for the hydrogen storage technologies we are considering. Discussion about each type follows in the sections below.

3.1.3.1 High Pressure Gas

Hydrogen has been stored for decades in carbon steel or aluminum cylinders in applications where weight is not critical such as in laboratory R&D, and in chemical manufacturing. Examples of these tanks can be found in most specialty gas catalogues, for example Matheson Tri Gas. Matheson provides hydrogen in Type 1A carbon steel cylinders, which contain 0.503 kg of hydrogen at a pressure of 2200 psi. Figure 16(a) shows a “6 pack” of these Type 1A cylinders in use outside the high-pressure hydrogen laboratory at Sandia National Laboratories in Livermore CA.

The empty (tare) mass of the 1A hydrogen cylinder is 52.0 kg, and the tank’s outer volume is 53.18 L. One can also purchase hydrogen from Matheson Tri Gas in Type 1R aluminum tanks at a pressure of 2015 psi, with a hydrogen capacity of 0.304 kg. This tank has a tare mass of 22.0 kg, and an outside volume of 39.53 L.

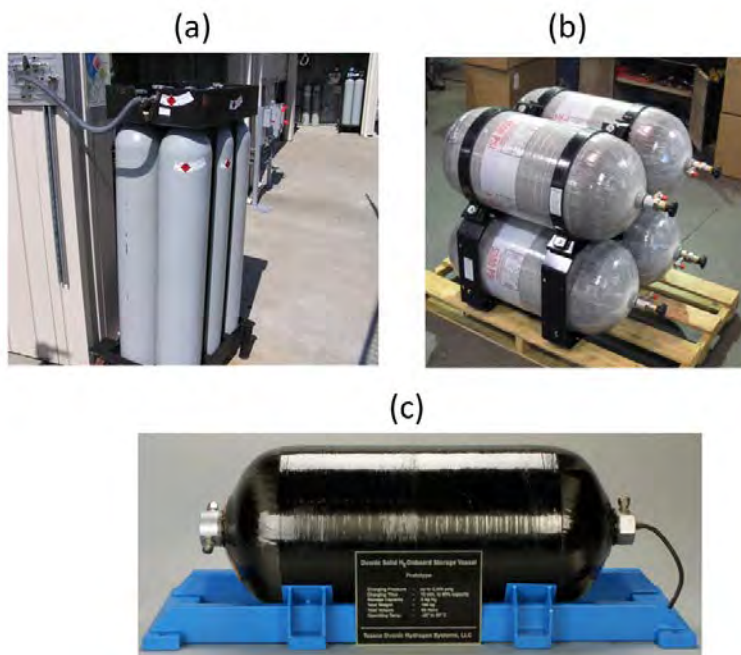

Figure 16: Photographs of three types of high-pressure hydrogen storage tanks: (a) carbon steel; (b) composite and (c) metal hydride.

These types of commercial tanks are the most common ways of storing high-pressure hydrogen gas. However, they are heavy, and because the hydrogen pressure is only ~ 2000 psi, not much hydrogen can be stored in them. One can see right away the challenge of storing 1000 kg of hydrogen needed for the SF-BREEZE in this way when an individual tank only holds ~ 0.5 kg.

For the Type 1A Matheson steel tank, we have 103.4 for the gravimetric spec, and 105.7 L/kg for the volumetric spec. For the Type 1R aluminum tank, we have 72.37 for the gravimetric spec, and 130.0 L/kg for the volumetric spec.

The gravimetric spec for the tanks can be improved considerably by going to carbon fiber overwrapped pressure vessels (COPV) (i.e., “composite tanks”). In a Type III tank, an aluminum inner shell is used as the material of contact with the hydrogen gas. Figure 16(b) shows a picture of composite Type III tanks from Structural Composites Industries (SCI). Aluminum is chosen for the inner liner because it is light, and does not suffer hydrogen embrittlement. The pressure rating of the aluminum liner would typically be ~ 3000 psi. This rating can be increased to 5000 psi by wrapping the aluminum liner with adhesive carbon fiber tape. The carbon-fiber overwrap is light, but expensive. Taking some information for different pressure ratings of these tanks circa 2007 from Lincoln Composites, we find one tank can store 1.6 kg of hydrogen at 5000 psi with a tank tare mass of 31.1 kg and a tank outer volume of 104.5 L. The gravimetric spec for this tank is 19.44 and the volumetric spec is 65.31 L/kg. Note that the volumetric spec of hydrogen gas itself at 5000 psi is 43.4 L/g. A similar Lincoln Composites tank with a higher pressure rating of 7,000 psi service pressure has a gravimetric spec of 16.21 and a volumetric spec of 49.69 L/kg. Lincoln Composites also offered at that time a 10,000 psi rated hydrogen tank which could

store 1.2 kg of hydrogen, with gravimetric spec of 23.50 and volumetric spec of 42.12 L/kg. Note that the volumetric spec (or density) of hydrogen gas itself at 10,000 psi is 25.6 L/kg.

In more recent product offerings, Luxfer, a major manufacturer of composite tanks, offers a number of different tanks at various pressure ratings and amounts of stored hydrogen which shows how incremental improvements in composite tank technology have been made over the past 10 years. Table 5 lists the gravimetric and volumetric specs for these composite tanks as well as for the non-composite tanks mentioned earlier.

Some general trends and conclusions can be drawn from Table 5. First, the non-composite tanks (carbon steel, aluminum) are very heavy, with gravimetric specs ~ 5 times worse than composite tanks. Their volumetric specs are ~ 2 times worse than the composite tanks because their rated pressure is typically lower (~ 2,000 psi versus at least ~5,000 psi for the composite tanks). As a result, these metal tanks, while inexpensive compared to composite tanks, are too heavy for the weight sensitive SF-BREEZE application, and bigger than one would like given space limitations on a high-speed ferry. The traditional carbon steel or aluminum hydrogen tanks will not be considered further.

Table 5 shows that as the pressure rating of composite tanks increases, the gravimetric spec first improves in going from 5,000 psi to 7,000 psi, but then degrades in going further to 10,000 psi. There is a “sweet spot” in pressure at 7,000 psi, and in fact ~ 6500 psi is optimal in a composite tank to minimize the gravimetric spec. The tank mass increase at 10,000 psi that is required to make the aluminum liner/wrap system strong enough to hold back the pressure is greater than the extra hydrogen mass that can be stored by increasing the pressure.

The difficulty lies in hydrogen being a real gas instead of an ideal gas. As discussed by San Marchi and coworkers [51], the Abel-Noble equation of state is a single parameter relationship describing how the volume of hydrogen changes with pressure:

$$V_m = RT/P + b$$

Where V_m is the molar volume, R is the gas constant, T the temperature, P the pressure and b is a constant. The Abel-Noble equation of state originates from the van der Waals equation of state for gases [51]. The parameter b represents the finite volume of the gas molecules, which is a weak function of pressure and temperature for most engineering applications (thus approximated as the constant b). For hydrogen, b takes the value 15.84 cm³/mole, for pressures below about 29,000 psi (200 MPa).

Figure 17 plots the relationship of molar volume V_m versus pressure for hydrogen using the Abel-Noble equation (upper black curve) and the ideal gas law (bottom red dashed curve).

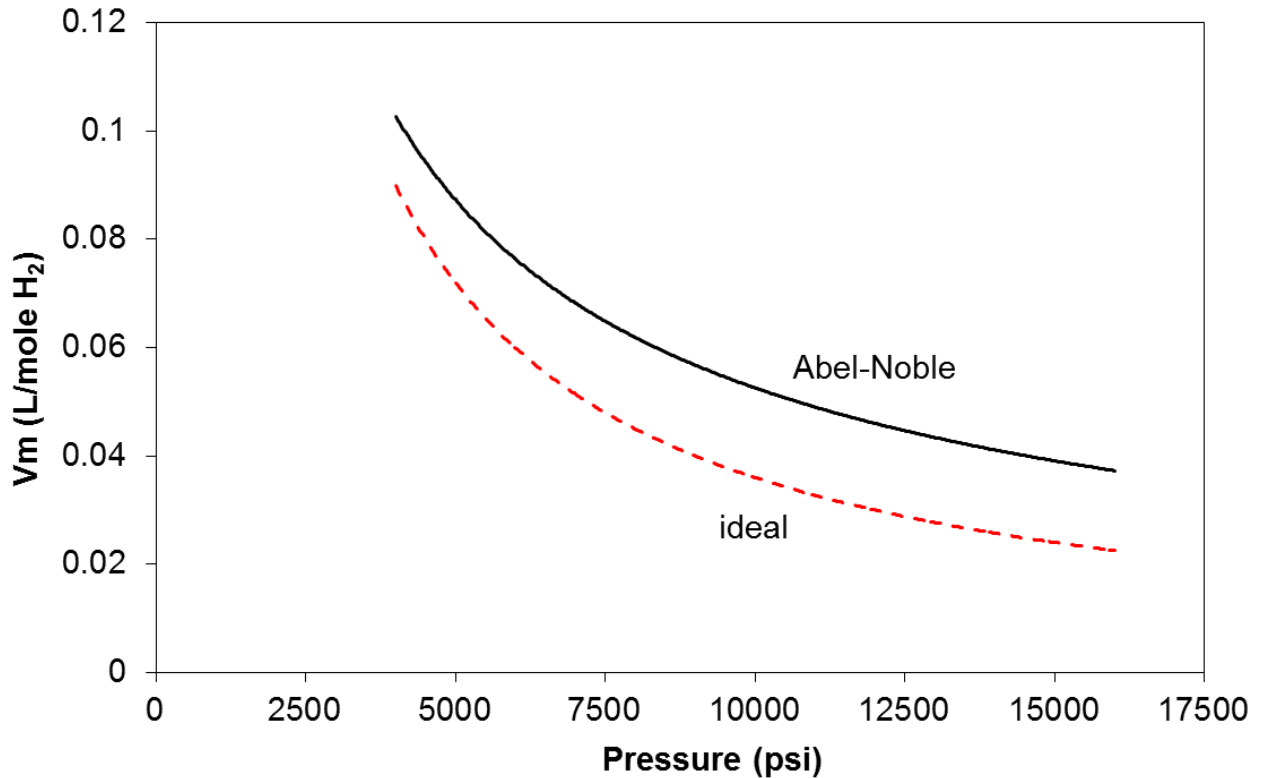

Figure 17: Relationship between molar volume V_m and pressure for hydrogen using the Abel-Noble equation of state (black curve) and the ideal gas law (red curve).

Figure 17 shows that at any given gas pressure, the real molar volume for hydrogen is larger than that predicted by the ideal gas law ($PV = nRT$). Figure 17 also shows the diminishing returns on gas storage density that can be achieved by going to higher and higher gas pressures. Intermolecular repulsions between real hydrogen molecules limit how close one can squeeze them together with applied pressure.

While Table 5 gives the gravimetric and volumetric storage specs for the tanks themselves, it must be realized that in practice, these tanks have to be assembled together into hydrogen storage systems. Figure 18 shows a typical example of how such tanks could be assembled into “pods.”

For discussion purposes, we consider 20 Luxfer Model W320H hydrogen tanks that are 16.5 inch in diameter, 123” long, holding 7.7 kg of hydrogen each at 5000 psi. Each tank weighs 304 pounds empty. The mass of the pod would be the mass of 20 tanks, plus 100 kg of mounting hardware, giving a total pod system mass of 2860 kg. The total volume for the pod, given the dimensions of Figure 18 is 19,320.6 L. Since the pod stores 154 kg of hydrogen, the pod system gravimetric spec is 18.57 and the pod system volumetric spec is 125.45 L/kg. These pod system gravimetric and volumetric specs are also listed in Table 5, where it can be seen that the practical requirement of assembling composite tanks into manageable pods has a minor penalty for the gravimetric spec, but a large penalty of 2.28-times the volumetric spec.

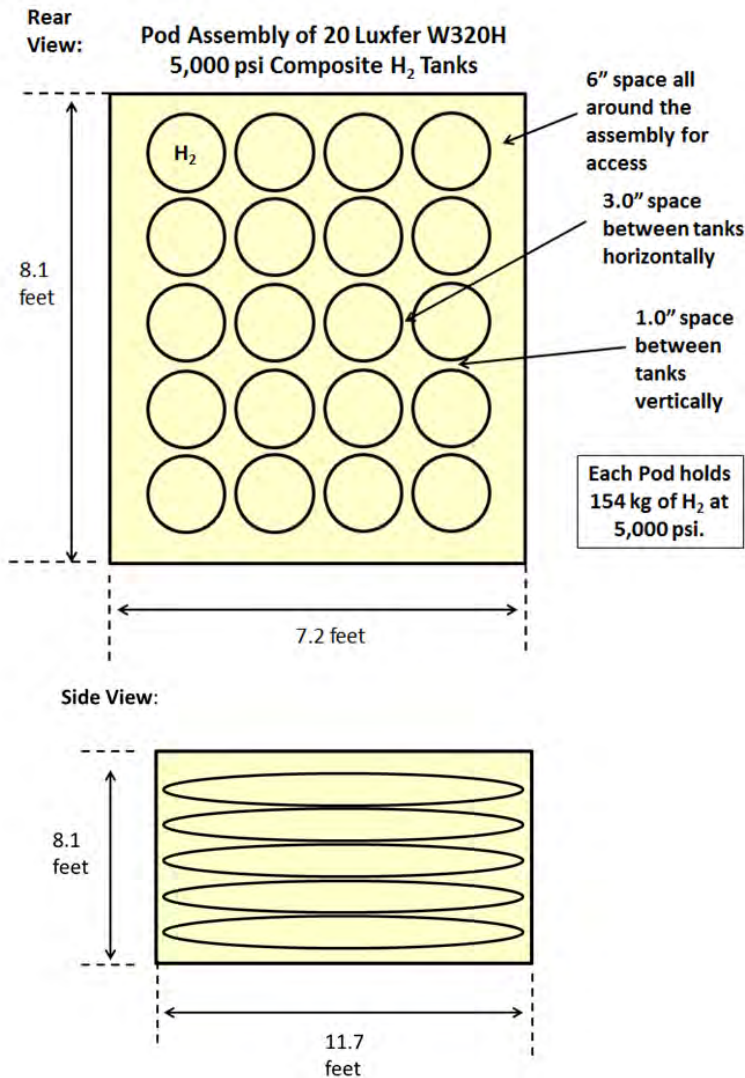

Figure 18: A “pod” formed from assembling together 20 Luxfer Model W320H 5,000 psi hydrogen storage tanks: (Top) end view; (Bottom) side view. Drawings are not to scale.

3.1.3.2 Solid-State Hydrogen Storage

The development of hydrogen storage technology has been driven to a large degree by the light-duty fuel cell application, namely, for use in fuel cell passenger cars. This application places greater demands on the “volumetric spec” than on the “gravimetric spec” (although both are important) because of the limited space available on passenger cars. As a result, there has been a great deal of research the past ~ 20 years on finding a material that can soak up hydrogen like a sponge, concentrating it beyond the densities achievable with high pressure storage, and hopefully not add a prohibitive amount of system weight. This is the topic of solid-state hydrogen storage [52]. There are three broad types of hydrogen storage materials that have been investigated: chemical hydrides, sorption materials and metal hydrides.

Chemical hydrides are liquids that can store hydrogen in chemical bonds, and release H₂ when heated, but regenerating the original material requires chemical processing that can't be performed at a

hydrogen station [13]. An example of a chemical hydride is cyclohexane (C_6H_{12}). Cyclohexane can be "dehydrogenated" (releasing H_2) to benzene (C_6H_6) via the reaction: $C_6H_{12} \rightarrow C_6H_6 + 3H_2$. However, it requires an off-board chemical process (envisioned to be at a chemical plant) to "rehydrogenate" benzene back to cyclohexane. A number of liquid chemical systems analogous to cyclohexane \leftrightarrow benzene have been investigated [13]. Their advantages are that they would be liquid fuels and could be handled and dispensed like gasoline. However, unlike gasoline, after cyclohexane releases hydrogen onboard the vehicle, one has to remove benzene from the vehicle for refueling. If the dehydrogenated product (benzene in this example) is a liquid, it is reasonable to think this could be pumped off the vehicle. However, if the dehydrogenated material is a solid, one would have to replace the entire fuel tank with a freshly loaded tank in a "tank swapping" scheme.

The current status of liquid chemical hydrides is that they don't contain enough releasable hydrogen [13]. Also, they typically require too much heat to release their hydrogen (a thermodynamic problem). In addition, the automotive manufacturers are highly resistant to a "tank swapping" type of technology because it would be a dramatically different refueling paradigm. There is little current work on liquid chemical hydrides, or any other type of "off-board regenerated" hydrogen storage material, so the prospects for improving this hydrogen storage approach are very slim. There are no commercially available chemical hydrides or tank systems based on chemical hydrides. This is not a hydrogen storage technology suitable for the SF-BREEZE application.

Sorption materials are high surface area materials that can bind hydrogen as a molecule (as opposed to as H atoms in chemical compounds) [53]. They can store hydrogen with good gravimetric efficiency and with a good volumetric spec, but they require the material be cooled to liquid nitrogen temperature (77 K). The reason liquid nitrogen temperatures are needed is that the H_2 -material binding energy (required to hold H_2 on the material) is so weak that at ambient temperature the H_2 would desorb off the material. There is currently research being conducted on sorption materials to try to find a way to increase the H_2 -material binding so that one does not require the inconvenient and costly requirement of having the storage tank held at liquid nitrogen temperatures¹¹. The R&D progress is quite slow in this area. There are no sorption materials or tank systems based on molecular hydrogen sorption that are commercially available. This is not a hydrogen storage technology suitable for the SF-BREEZE application.

The third type of solid-state storage system is broadly characterized as "metal hydrides" [54, 55]. As the name implies, these are materials that contain metal atoms. An example is MgH_2 . It has been known for years that some metals can soak up hydrogen like a sponge, and then release it when heated. The interstitial metal hydrides store hydrogen as atoms by dissociating H_2 on the metal surfaces, and storing the atomic H that results in "interstitial" regions of the metal lattice [56]. Examples of metal hydrides in the "hydrogenated state" (filled with H) are $LaNiH_5$, PdH_2 and $Fe-Ti/H$. These are remarkable materials in that hydrogen can be released from the materials with very little applied heat, very pure hydrogen is produced, and the material can be regenerated simply by exposing again to hydrogen gas. They are

¹¹ The DOE Fuel Cell Technologies Office (FCTO) has recently funded a research consortium to further study hydrogen storage materials. The consortium is called Hydrogen Storage Materials Advanced Research Consortium (HyMARC), and is a collaboration between Sandia National Laboratories, Lawrence Livermore National Laboratories (LLNL) and Berkeley Lab.

typically "fast kinetically" meaning that the release of hydrogen and the regeneration with hydrogen are fast reactions, which allows them to release hydrogen rapidly when demanded by the vehicle fuel cell power plant, and allows for very fast tank refilling at the hydrogen station. Thus, in principle they form the basis of an "onboard reversible" hydrogen storage system, because the spent material does not have to be removed from the vehicle tank, and even better, one does not have to swap a tank out. Also, they can absorb hydrogen at low pressures, at first glance obviating the need for a specialized high-pressure tank and avoiding safety concerns about high-pressure systems. One can then fill the vehicle with hydrogen gas at the hydrogen station, with the metal hydride soaking up the hydrogen. Of all the solid-state hydrogen storage scenarios, the metal hydride scenario is most supported by the vehicle manufacturers.

The difficulty with metal hydride materials is that they are typically very heavy. La, Pd and Fe/Ti are all heavy metals, making the gravimetric spec for a tank system undesirable. Another undesirable aspect is that when the metals adsorb hydrogen, the material swells up (to accommodate the added H). The material can swell up to ~ 30% of its original volume, and the tank stress that can come from that swelling has to be accommodated in the tank design.

An example of a near-commercial prototype interstitial H₂ storage tank from Ovonic Hydrogen Systems is shown in Figure 16(c). (Ovonic was purchased in 2012 by Vodik Labs who is now the commercial supplier of the Ovonic alloys.) There exist a number of different alloy compositions with different properties. The tank shown in Figure 16(c) uses the Ovonic 679 alloy (OV679). The exact composition of the material is proprietary, but it is a transition-metals-based AB₂ type alloy with A = Ti, Zr and B = V, Cr, Mn, Fe, Al [57]. The alloy is contained in a composite tank. The reason why a composite tank (similar to the high pressure tanks) is needed is to accommodate tank stresses when the metal hydride swells when filled, which partially defeats one advantage of metal hydride materials, namely low pressure operation. Because the Ovonic material within the tank requires some heating to release H₂, there is a fin array within the tank which allows heat transfer to the metal hydride material from warm heating water from fuel cell waste heat. If heat is required to drive H₂ off the metal hydride material, this means that heat is released when the spent material is rehydrogenated. The fin array during refueling allows cooling water to circulate through the tank to remove this heat from the metal hydride bed during fueling. The prototype tank shown in Figure 16(c) is 84 cm in length, and has an outer diameter of 32.8 cm. The vessel weight with the alloy and thermal management structure installed is 190 kg. The vessel outer volume is 70.9 liters. The tank stores 3 kg of hydrogen. These physical attributes lead to a gravimetric spec of 63.3 and a volumetric spec of 23.6, as listed in Table 5.

The specs for the metal hydride tank indicate that while the volumetric spec is quite good, and better than any storage method discussed thus far, the metal hydride tank is very heavy, ~ 4 times heavier than storing the equivalent amount of H₂ in a 7,000 psi composite hydrogen storage tank. Due to this poor gravimetric performance, in addition to the fact that these tanks and their associated thermal management systems are not commercially available, we cannot consider metal hydrides (or any other solid state method of storing hydrogen) appropriate for the weight-sensitive SF-BREEZE application. Current research in these materials is focused on reducing the weight disadvantage by exploring more complex metal hydrides made of very light elements such as Li, C and B that can store the H atoms not

in interstitial regions, but in chemical bonds that are designed to weakly hold the H [54]. No material or associated tank system based on advanced complex metal hydrides is close to being commercially available. As was the case with chemical hydrides and sorption material, metal hydrides are not currently suitable for the SF-BREEZE application, and will not be considered further.

3.1.3.3 Liquid Hydrogen (LH₂)

In addition to high-pressure hydrogen storage, and solid-state storage of hydrogen, the third method is storage as liquid hydrogen (LH₂) [58]. LH₂ is a cryogenic liquid with boiling point of 20 K (-253.1 °C) (a detailed description of LH₂ properties is given in Section 3.2.6). The tanks which hold it can be thought of as highly engineered Thermos bottles, with an inner metal liner, separated from an outer metal liner with vacuum and perlite insulation (small glass particles) in-between. The insulation is not perfect, so there is always a small heat leak from the room temperature outer liner through the insulating spacer layer, through the inner metal liner and eventually to the LH₂ itself. Heat leak to the LH₂ causes boiling, with buildup of H₂ pressure within the inner tank. This H₂ must eventually be "vented" to relieve the tank pressure, resulting in lost hydrogen through "boil-off." The heat leak is less severe for larger LH₂ tanks because the quantity of hydrogen stored scales with the tank volume, (i.e., as the cube of the tank radius assuming a spherical tank) whereas the heat leak through the outer surface scales with the tank surface area (i.e., as the square of the spherical tank radius). Thus, LH₂ has been the traditional and successful method for storing large quantities of hydrogen (thousands of kilograms) with minimal and acceptable loss of hydrogen through boil-off. Spherically shaped tanks maximize hydrogen storage volume while minimizing surface area, and are thus ideal tank shapes. However, cylindrical tanks are much easier to manufacture (and therefore less expensive) and the surface area/volume ratio is only somewhat greater than spherical shapes. Thus, cylindrical LH₂ tanks are much more common. The heat leak problem is more severe for small LH₂ tanks as the radius shrinks. Thus, LH₂ storage is more challenging for storing small H₂ quantities such as the 5kg considered for fuel cell vehicles.

We initially investigated the gravimetric and volumetric hydrogen storage specs for well-known LH₂ tanks from Chart Inc.¹² used for storing hydrogen on land in stationary applications where the tank is not moved as it would be in a transportation application like the SF-BREEZE. Figure 19(a) and (b) show photos of stationary LH₂ tanks.

However, we quickly decided that we would want an LH₂ tank for the SF-BREEZE to be as durable as a road-worthy LH₂ tanks which have been used for decades to transport hydrogen. Figure 19(c) shows a ~ 4,000 kg LH₂ trailer tank operated by Linde. Therefore, we investigated the gravimetric and volumetric densities for a DOT-approved LH₂ tank design by contacting Gardner Cryogenics, the leading manufacturer of DOT-approved LH₂ tanks for trailers.

The discussions focused on a 1200 kg capacity LH₂ tank. The 1200 kg tank would allow delivery of 1000 kg to the fuel cells, while providing the residual LH₂ and gaseous H₂ conditions needed for refueling. In discussions with Gardner Cryogenics [59], the gravimetric spec would be 8.7 and the volumetric spec would be 24.8 L/kg for a DOT-approved LH₂ tank. These specs are listed in Table 5. The volumetric spec

¹² www.chartindustries.com

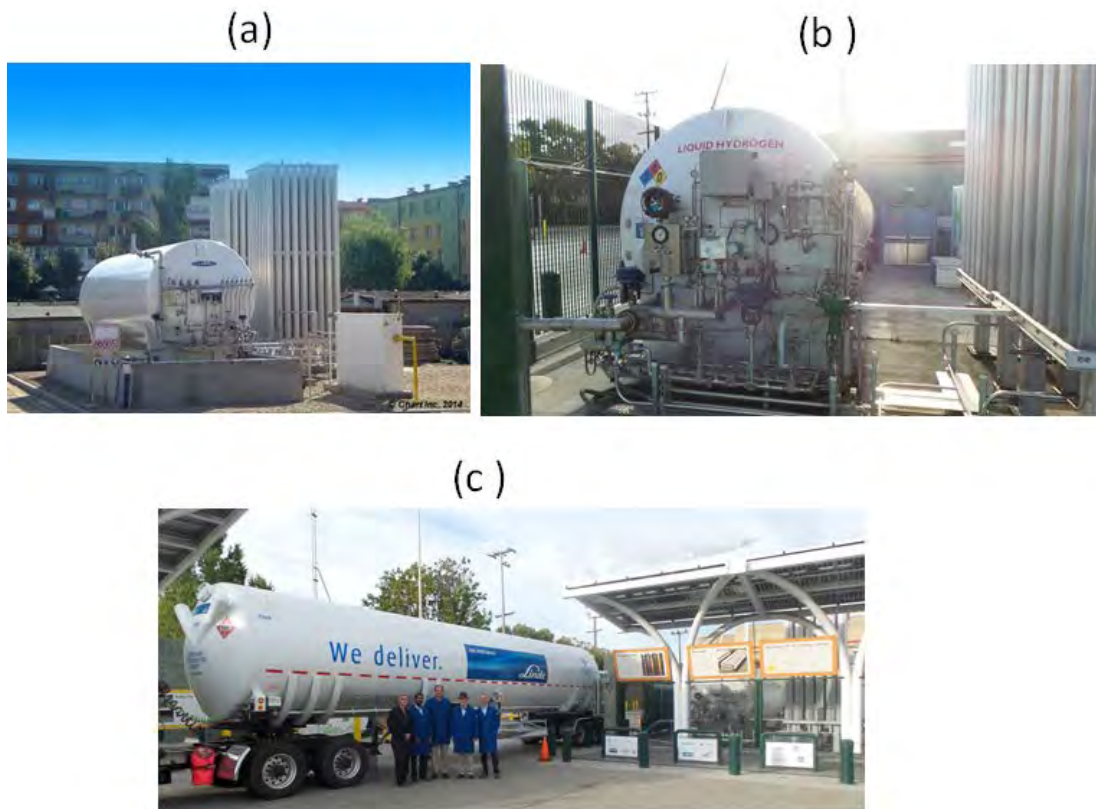

Figure 19: Examples of LH₂ tanks: (a) Chart Inc. LH₂ tank; (b) Linde Group LH₂ tank at the AC Transit Hydrogen Station in Emeryville CA and (c) Linde LH₂ refueling trailer at the AC Transit Station.

(i.e. density) for LH₂ itself is 14.08L/kg. Note that these specs are for the LH₂ tank itself, and does not include the mass/volume of the evaporator which is required for LH₂ use. If one were to include this extra piece of equipment in the gravimetric spec, the gravimetric spec would increase from 8.7 to 9.4.

It is clear from Table 5 that LH₂ storage has by far the best gravimetric spec, providing hydrogen storage at half the mass as the best competitor (7,000 psi high pressure storage) while also providing nearly the best volumetric specification. Only metal hydride storage provides a slightly better volumetric storage specification. Since LH₂ storage provides the best gravimetric spec and nearly the best volumetric spec, we choose LH₂ storage as the hydrogen storage method of choice for the SF-BREEZE high-speed fuel cell ferry.

Apart from the benefits of light weight and small volume, there are many other attendant benefits of choosing LH₂ as the storage method of hydrogen. These benefits include:

- 1) LH₂ storage does not require high pressures. While the high-pressure composite tanks are very safe, and the composite tank manufacturers deserve a lot of credit for making such a reliable product, there exist perceptions about the safety of having such high pressures (5,000 - 10,000 psi) near people. These concerns have been largely addressed by the light-duty vehicle manufacturers, who will be using 5,000 - 10,000 psi storage of small quantities (~ 5 kg) on the first fuel cell vehicles. However, for the larger

(~1000 kg) quantities for the SF-BREEZE, it's advisable to avoid high pressures if possible. The highest system pressure in the 1200 kg LH₂ tank for the SF-BREEZE would be determined by the tank's hydrogen vent pressure relief valve, which is a modest 150 psi.

2) LH₂ storage has been used for decades for space applications (both the Apollo Saturn V and Space Shuttle launch vehicles used very large quantities of LH₂), and has also been transported on the roads in tankers for decades with an excellent safety record. The properties of LH₂ are well understood, and LH₂ storage and transport are mature technologies.

3) With LH₂ stored on the vessel, it can in principle be fueled directly from a LH₂ tanker brought to the waterfront by the gas supplier. In principle, this would not require a "hydrogen station," providing more flexibility for refueling in the early years of SF-BREEZE deployment.

4) LH₂ tank technology scales well. Building much larger LH₂ tanks (for vessels much larger than the SF-BREEZE) does not introduce new problems, and can readily be accomplished.

5) As described in Section 3.2.6, LH₂ is very similar in its physical and combustion properties to liquid natural gas (LNG). Since LNG ships are already being designed by naval architects, and approved by the international and domestic shipping authorities, LH₂ is a natural extension of LNG maritime technology. This provides the benefit that naval architects, EBDG in the SF-BREEZE project, having LNG design experience, can readily design hydrogen fuel cell vessels once the minor difference between LNG and LH₂ are described, and they have acquired fuel cell expertise. In addition, the domestic maritime authorities (U.S. Coast Guard, American Bureau of Shipping) and international regulatory bodies are already writing the codes and standards for safe use of LNG on vessels. These codes provide a basis for consideration to allow for the safe use of LH₂ on hydrogen fuel vessels based on similarity with LNG.

The SF-BREEZE LH₂ tank would be very similar to existing ISO LH₂ tanks that has been in use by Linde (and others) for years [60] to transport LH₂ as cargo around the world. Figure 20 shows a picture of a Linde ISO tank mounted on a trailer.

This ISO tank has an inner liner made of 304 stainless steel. The ISO tank is 240 inches long, with an outer diameter of 102 inches, giving an outer volume of 32,120.5 L. The empty (tare) weight is 11,315 kg (24,945 lbs), with a working pressure of 188 psi. The boil-off rate is 0.5 %/day, and stores 1295 kg of LH₂.

Similar to the Linde ISO tank of Figure 20, design conversations with Gardner Cryogenics indicates the 1200 kg LH₂ tank of the SF-BREEZE would have the following physical attributes [59]: The empty mass of the tank would be $8.7 \times (1200 \text{ kg}) = 10,440 \text{ kg}$ (23,016 lbs). The mass when fully fueled would be $10,440 \text{ kg} + 1200 \text{ kg} = 11,640 \text{ kg}$ (25,662 lbs). The outer volume would be $24.8 \text{ L/kg} \times (1200 \text{ kg}) = 29,760 \text{ L}$. The outer dimensions of the tank would be 102 inches diameter by 222 inches long. The interior water volume of the tank would be 16,901 L. The 1200 kg tank would allow delivery of 1000 kg to the fuel cells, while leaving 200 kg to keep the tank cold for refueling. The inner 304 stainless steel liner would be 3/8" thick, and the outer carbon steel liner would be 1/4" thick [59].



Figure 20: Photographs of a Linde ISO LH₂ container (tank) mounted on a trailer. The rectangular frames on the tank allow for convenient lifting and transport. The specifications written on the side of the tank are shown in the lower picture.

Like all LH₂ tanks in service, the LH₂ tank of the SF-BREEZE would be equipped with a vent stack, which allows hydrogen boil-off from the tank, if it were sitting idle, to be vented above the vessel. As described in Section 3.2.6, since hydrogen is so buoyant, it will rise straight up when vented. Hydrogen consumption estimates indicate that if the boat is moving at all, or is consuming hotel power, there is no hydrogen boil-off venting, because the hydrogen consumption by the fuel cells for power greater than 7.5 kW is greater than the hydrogen vented by normal boil off. If the power load is less than approximately 7.5 kW, there will likely be an accumulation of pressure within the tank. The time before this results in vented hydrogen (boil off) depends on the initial pressure of the tank and the hydrogen consumption rate and could be anywhere from several days to several weeks.

LH₂ tanks have a series of pressure relief devices that are meant to prevent explosive over pressuring [61], for example if a fire occurred underneath the tank. Considering an anomalous temperature increase in the LH₂ tank, there is an “overboard” regulator which normally opens at ~150 psig, venting hydrogen up the vent stack. The flow capacity of this valve could be overcome by a very strong temperature excursion. If the pressure continues to rise to a pressure of ~ 175 psi, there is another pressure safety valve that opens with a significantly higher flow capacity. Although designed for very high flow rates, if the ~ 175 psi pressure safety valve is overcome, and pressure still continues to rise,

there is a tank burst disk that will rupture at 210 psi. The burst disk also opens to the vent manifold, venting all contents of the LH₂ tank (both liquid and gas) up the vent stack. If the burst disk were to be in operation, first responders or crew members need to switch a 3-way transfer valve to close off the system in order to prevent oxygen from entering the tank once all LH₂ and pressure is gone [61]. This system could be made to operate remotely or even automatically if desired.

The inner 304 stainless steel liner would be 3/8" thick, and the outer carbon steel liner would be 1/4" thick [59]. In comparison to conventional gasoline or diesel fuel tanks used in today's over-the-road transport trailers, the LH₂ tank for the SF-BREEZE would be considered "armored." Air Products has reported that LH₂ tanks in the field have been struck by hunting ammunition [62]. Due to the curved nature of the tanks, and the 1/4" thick steel outer liner, no negative effects resulted. Air Products also reports that LH₂ tanks on trailers have been in road accidents, where the trailer has turned over. In no case have LH₂ tanks been breached. A general schematic of such a tank is shown in Figure 21.

We conducted an analysis of the normal venting coming from the SF-BREEZE LH₂ tank vent stack. Recall that hydrogen is a non-toxic gas that is not a greenhouse gas. Furthermore, it is so buoyant that any hydrogen released to the air will eventually leak into space. Thus, there is no environmental impact to venting hydrogen. However, for flammability concerns, we assessed how much hydrogen would be going up the vent stack if the SF-BREEZE were completely turned off.

Figure 22(a) shows a picture of a dual vent stack on the LH₂ tank at the AC Transit hydrogen station in Emeryville CA. For the SF-BREEZE, there would be only one vent pipe, with a branched opening into two exit pipes. Gardner cryogenics has quoted that one of their DOT-approved LH₂ tanks would vent hydrogen at 0.6 %/day. For our analysis, we conservatively estimate a total venting rate of 1 %/day. These tanks are designed so that all hydrogen boil-off from the tank is brought up to room temperature before being injected into the vent stack by passing the gas through coiled piping external to the tank. Thus, the hydrogen vent gas is very buoyant. It is difficult to assign a precise rising velocity to hydrogen gas, because the shape of the release is unknown, which affects the atmospheric drag on the rising volume. We will be conservative and consider the rising terminal velocity to be 5.0 m/sec (11 mph).

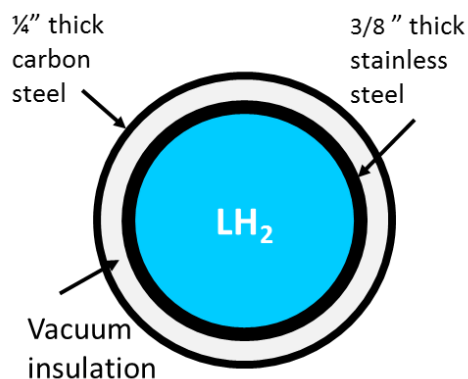

Figure 21: Cross section of a typical road-transport LH₂ tank showing the double liner approach (not to scale). The double liner provides ultra-insulation properties as well as extremely high resistance to damage. The SF-BREEZE will use the same kind of tank.

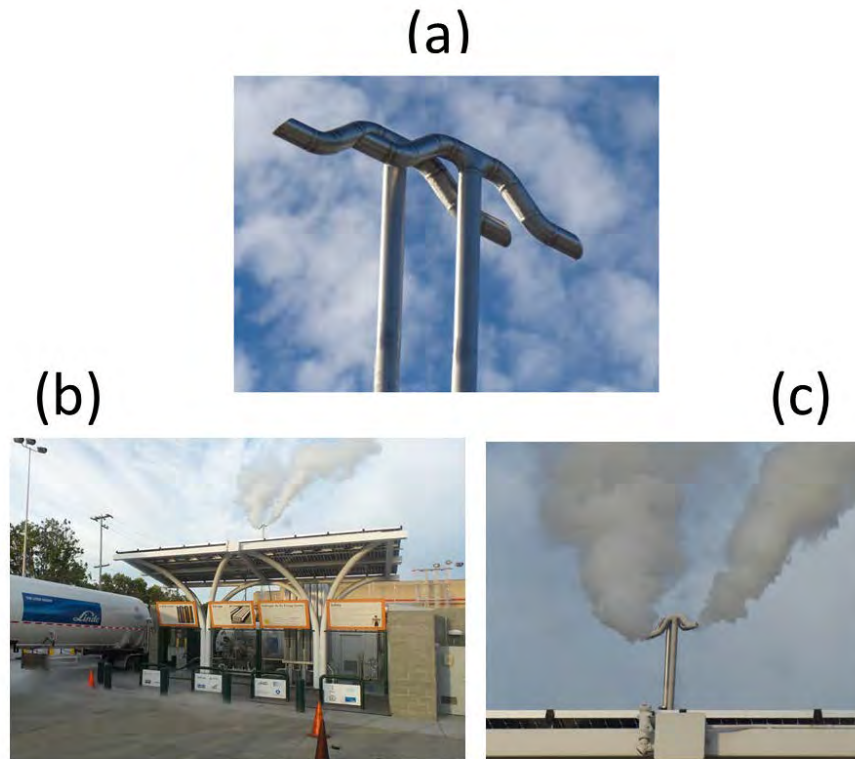

Figure 22: Dual vent stacks on the LH₂ tank at the AC Transit Hydrogen Station in Emeryville CA. (a) Vent exit ports; (b) cold hydrogen gas from the Linde trailer being vented out the LH₂ tank hydrogen vent stacks and (c) close-up of the strong buoyant behavior of even very cold hydrogen gas during the vent of the Linde trailer. The plumes in pictures (b) and (c) are water condensation clouds (fog) from the release of cold hydrogen gas. Note that the SF-BREEZE tank would never vent such large quantities of hydrogen gas.

When Linde is transferring LH₂ from their truck into a stationary tank, they pressurize their trailer tank up to about 120 psi with cold hydrogen gas. When finished with the LH₂ transfer, DOT regulations require they reduce the tank pressure to ~ 50 psi [61]. The delivery technician sometimes does this by releasing the cold trailer H₂ gas out the station vent stack, leading to the venting of large quantities of cold (~ -195 K, -78 °C) H₂ gas. This trailer venting is shown in Figure 22(b) and (c). This large quantity of H₂ gas would *never* be vented out the SF-BREEZE vent stack unless in the event of a severe failure of insulation in conjunction with a fire. Also, SF-BREEZE venting would always be at room temperature. Nonetheless, Figure 22 does show how buoyant even cold hydrogen gas is. Despite being ~100 degrees C below room temperature, the vented trailer H₂ gas still goes straight up upon exiting the vent stack. (The H₂ is invisible, but the water condensation cloud indicates the path of cold H₂.)

Assuming 1 %/day boil off, we will lose 0.139 grams/second of H₂ for the 1200 kg LH₂ tank with no demand of any kind on the SF-BREEZE fuel cell power systems. The propulsion power of the SF-BREEZE at 35 knots is 4.4 MW. The hydrogen consumption rate at 35 knots is 147 grams/second. So, we are consuming hydrogen far in excess of the boil-off vent rate, which means we won't be venting "boil-off" hydrogen at 35 knots. Even if the boat is going 1 knot, assuming linear dependence of speed and H₂ consumption, the hydrogen consumption rate is 4.2 grams/second, still 30 times larger than the quoted

boil off rate from the 1200 kg tank. So, if there is any powered movement of the SF-BREEZE at all, there will be no venting of boil-off H_2 out the stack. Linde confirms that the pressure in the head space can be controlled¹³ so that during use, the pressure in the tank never exceeds the vent pressure in normal operation [61].

The electrical power needed to fully consume 0.139 grams/second in the fuel cells is 7.5 kW assuming 53% fuel cell efficiency. A hotel load of this size would prevent any boil-off venting of H_2 . Linde has stated that there will be no vent stack release of H_2 during refueling and that the venting of boil-off gas would be slow and steady, not in bursts of gas [61]. For more information on the venting that may occur during bunkering we refer the reader to Section 4.1.2.

How quickly does H_2 vented out the stack dissipate so that it becomes diluted below the hydrogen LFL of 4.0%? Figure 23 depicts hydrogen coming out of one of the two vent openings on the tank vent pipe.

Consider a 2" (5.08 cm) diameter vent pipe pointing straight up. This is one of the two vent exit locations (ports) with a common vent stack pipe. With normal boil-off, hydrogen venting at 1 % /day produces 0.139 grams/second total, or 0.0694 g/second out of one pipe exit hole. With a rising velocity of 5.0 m/s, in one second the H_2 has risen 5 meters = 500 cm.

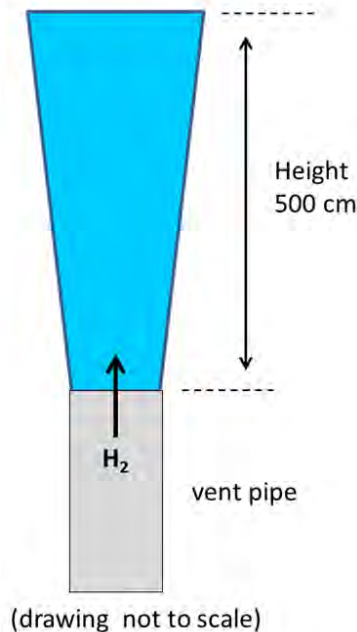

Figure 23: A diagram depicting the venting of hydrogen gas out of a single vent stack exit port. The horizontal and vertical dimensions of the diagram are not to scale.

¹³ There are two hydrogen outlets on the tank, one near the top (in the cold gas space) and one near the bottom (from the liquid space). Withdrawing hydrogen from the gas space will reduce tank pressure faster than withdrawing from the liquid space. In addition, an integrated pressure build system can increase the pressure as desired. The fuel system can be configured to automatically control which outlet port is used (to moderate the reduction in pressure due to use) and the activation of the pressure build system (to increase the pressure if needed) to maintain a setpoint tank pressure.

Diffusion velocities laterally are much smaller than buoyant velocities, and are ~ 2 cm /sec at normal temperature and pressure [14]. So diffusion broadens the cylinder into a cone, but the H₂ release is rising a lot faster than the release is broadening. Assuming completely quiescent air, the % volume of hydrogen in the dispersion cone is at 3.5 % after 1 second, below the LFL for H₂. Any boat movement or wind reduces the hydrogen/air concentration even further.

These considerations show that for the SF-BREEZE, it is reasonable to allow venting of hydrogen to take place out of the vent stack. The reasons are:

1. H₂ is non-toxic, and not a greenhouse gas (no environmental impact). In any event, H₂ will remove itself from the planet.
2. Boil-off will occur ONLY when the SF-BREEZE is sitting turned off with no passengers when SF-BREEZE is out of service.
3. Vented H₂ drops below the 4% LFL of hydrogen within 1 second of release (conservative), so there is no credible ignition risk from boil-off venting
4. Since the venting is at room temperature, and the vent stack is up high, there is no risk of hydrogen entering passenger areas from boil-off venting because H₂ is so buoyant. The vent gas, diluted below the 4% LFL (see 3 above), will go straight up.

3.1.3.4 Summary of the Hydrogen Storage Selection

The currently available options for storing hydrogen on the SF-BREEZE were reviewed. The traditional metal tanks (carbon steel, aluminum) are too heavy for the weight-sensitive high- speed ferry application. Solid-state hydrogen storage is also too heavy and is not yet commercially available. Composite hydrogen tanks are lighter, but are not as gravimetrically or volumetrically attractive as using LH₂ storage. The many advantages to using LH₂ storage were also reviewed. With LH₂ as the storage method of choice, the design and gravimetric and volumetric specs were developed for a 1200 kg DOT-approved LH₂ tank suitable for the SF-BREEZE. The vent hardware associated with these tanks was reviewed, along with their operation in the face of accidental loss of insulation and temperature control of the LH₂ fuel. Finally, a description was given of the dispersion of hydrogen out the vent stack, indicating that vented H₂ will dilute to below the 4% LFL within 1 second of venting over a distance of 5 m.

3.1.4 Vessel Design

The naval architecture and design firm Elliott Bay Design Group (EBDG) was contracted to provide a comprehensive design package for the SF-BREEZE ferry. This was done in order to ensure that any determination of feasibility includes an accurate assessment of how such a novel vessel would be designed and built. The EBDG design package is attached in its entirety in Appendix A and is considered an integral and necessary part of this report. This section will not repeat the content of the design package, but will discuss some key areas. The design package contains the following elements:

1. Design Study Report
2. Qualitative Hull Comparison Study
3. General Arrangement and Outboard Profile Drawings

4. Parametric Weight Estimate
5. Speed and Powering Calculations
6. Tonnage Memo
7. Bunkering Procedure (discussed in Section 4.1.2.1)
8. Preliminary Risk Assessment (discussed as part of Section 3.2)
9. Hazardous Zone Drawings (discussed in Section 3.2.3)
10. Parametric Cost Estimate (discussed in Section 5.1.1)

The EBDG design package is not a detailed design. In some cases the reader will notice that details of specific systems are not given. The purpose of the design package was to determine whether it is feasible to build and operate such a vessel. In some aspects of the design there are several options on how to implement certain features. For sake of efficiency, when it was determined that at least one of these options is feasible from technical, regulatory, and cost perspectives, the design effort intentionally did not pursue further detail or make the final choice.

As an overview, Figure 24 gives engineering models of the final design of the SF-BREEZE. The top deck holds a cylindrical 1200 kg capacity LH₂ tank, with enough hydrogen for 4 hours of continuous operation. A desire to refuel only a couple of times per day drives the 1200 kg capacity specification. The high-

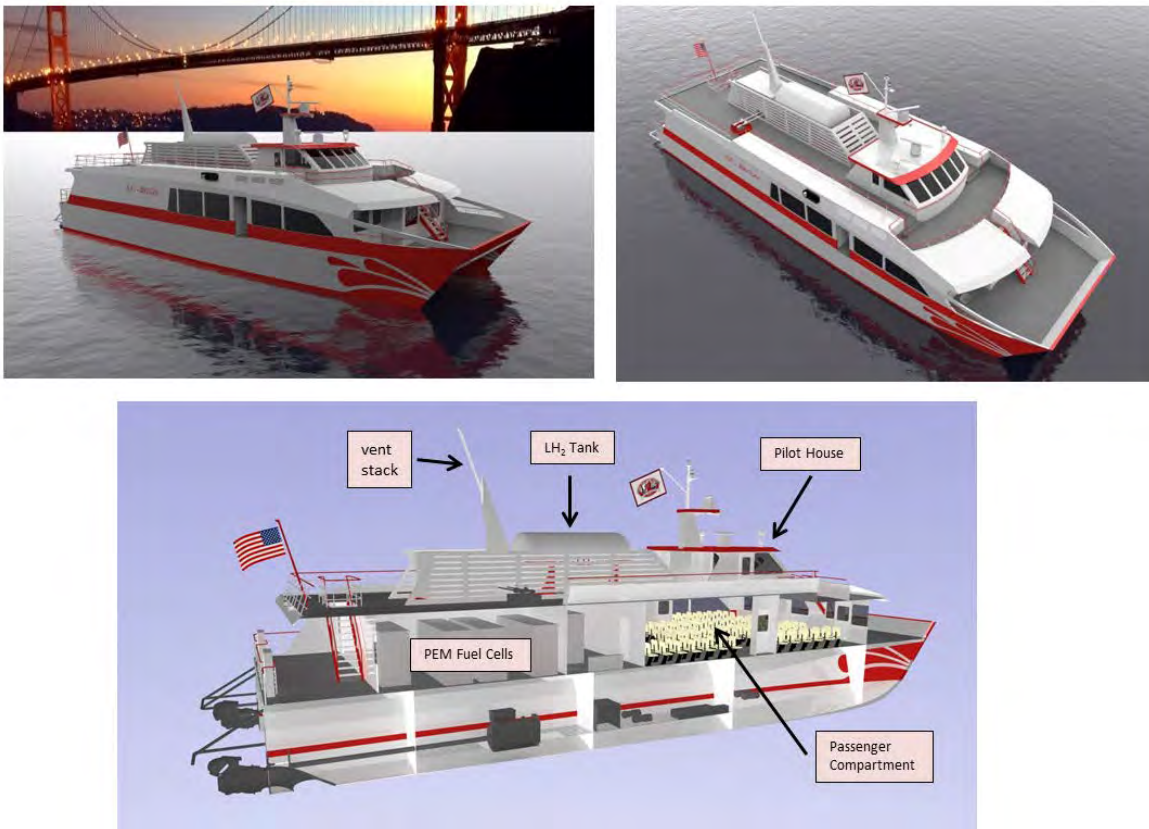

Figure 24: Final engineering models of the SF-BREEZE as designed by Elliott Bay Design Group. The top deck holds the LH₂ storage tank, the associated vent stack, evaporation equipment, and the Pilot House of the vessel. The main deck holds the PEM fuel cell power racks and the passenger compartment.

speed (35 knots) specification requires the lightest method of storing 1200 kg of hydrogen, namely LH₂ storage in a DOT-approved double-walled cryogenic tank. The forty-one 120 kW fuel cell racks are located on the main deck, aft of the passenger compartment. The fuel cells are of the PEM variety, selected for their fast turn on, minimal weight, commercial availability, established track record and ability to run on pure hydrogen.

3.1.4.1 Design Study Report

The design study report (DSR) is the overall summary document for the design. The DSR incorporates information from all other documents as well as from other project partners. For example, the “owner requirements” were determined from the project team as summarized in Section 3.1.1 (performance requirements), Section 3.1.2 (choice of powerplant), and Section 3.1.3 (choice of hydrogen storage). Regulatory requirements were determined from referenced regulations and guidelines and frequent regular discussions with USCG and ABS (a discussion of the regulatory aspects of the design package is given in Section 3.2).

The DSR includes examination of pollutant and greenhouse gas (GHG) emissions. A detailed examination of GHG emissions is also given in Section 3.1.5 and an extension of the pollutant emission findings in Section 3.1.5.4.

3.1.4.2 Qualitative Hullform Comparison Study

The purpose of the qualitative hullform comparison study was to evaluate monohull, catamaran, and trimaran hullforms across various characteristics. Sketches were made showing the different hulls with generic blocks for the propulsion motors, fuel cells, and hydrogen tanks. The evaluation and sketches were combined to identify a preferred configuration.

The hullform study concludes that a catamaran is the best choice for the SF-BREEZE. Interestingly this has very little to do with the fact that the SF-BREEZE has a novel powerplant, and is primarily a result of the high-speed nature of the vessel. A benefit of the catamaran approach is that it allows the LH₂ tank to be placed on the top deck while maintaining sufficient stability.

One assumption in the hullform study is that locating the LH₂ tanks below passenger accommodation space was assumed to be not preferred in the current regulatory environment as well as physically difficult due to the sizes of the demihulls. While this assumption did not affect the choice of the catamaran hull for the SF-BREEZE, it should be noted that regulation does not prohibit such location. In lower speed craft where a monohull is more appropriate, an approach that is acceptable by regulation should be examined in more detail.

3.1.4.3 Parametric Weight Estimate

The parametric weight estimate provides values for the total weight of the SF-BREEZE, along with estimates for all of the subcomponents including hydrogen storage, fuel cells and other equipment. One feature of this estimate is the comparison to the *Vallejo* ferry, a 300 passenger ferry operated by the San Francisco Bay Ferry/Water Transit Emergency Authority (WETA). Pictures of the *Vallejo* and the SF-BREEZE are shown in Figure 25. The SF-BREEZE’s weight is estimated to be 10% heavier than the *Vallejo* even though it carries fewer passengers; this is due to the larger size of the SF-BREEZE needed to

carry the volume of fuel cells and the LH₂ tank and the weight of the fuel cell and LH₂ system compared to similarly-sized diesel engine and fuel. The weight estimate also includes a 5% additional margin.

3.1.4.4 Speed and Powering Calculations

As EBDG's Speed and Powering assessment states:

Speed and power calculations are critical because the required power determines the required number of fuel cells, which are expensive as compared with a conventional diesel configuration.

The determined power of the vessel required to make the design speed has a very large impact on the cost of the ferry due to the high per-unit cost of the fuel cells. Already the SF-BREEZE design has proven to be heavier than a conventional ferry. (One note of clarification – the Speed and Powering assessment says that an overall weight design margin was not included in the analysis; however, the Speed and Powering calculations use the weights from the Parametric Weight Estimate which include a 5% design margin.)

The sensitivity of the vessel's power to weight is revealed by the following:

The sensitivity of the vessel power to weight changes amounts to approximately a 1.1% change in required power for a 1% change in weight. For example, if the vessel weight were increased by 1,000 lb, an additional 16 kW of power would be needed to maintain 35 knots, or if the weight increased by 7,500 lb, one additional 120 kW fuel cell rack would be needed.

Each 120 kW fuel cell rack is estimated to cost \$300,000 today (Section 5.1.1), so the cost per weight increase can be estimated at \$40,000 per 1,000 lb added to the vessel's design – and this does not include other potential associated costs such as increased sizes of other parts of the electric drivetrain (power conditioning, motors).

Another margin included in the Speed and Powering calculations is through the fact that transom lift devices¹⁴ were not considered in the design. Including such devices would require detailed hydrodynamic analyses that were out of the scope of this study. Inclusion of these devices is estimated to be able to reduce required power by 5%-10%. If a 10% reduction in power could be achieved through a lifting device, the installed propulsive power requirement would be reduced from 4.80 MW to 4.32 MW.

Comparing the SF-BREEZE power requirement to that of the Vallejo, the Vallejo has 3.4 MW of propulsive power installed and carries 300 passengers for a power-per-passenger of 11.3 kW, while the SF-BREEZE has 4.8 MW installed and carries 150 passengers for a power-per-passenger of 32 kW.

The Speed and Powering Calculation shows the technical feasibility of powering the SF-BREEZE at 35 knots, which is a significant step forward for zero emission technology. However, it is also clear from

¹⁴ As described by EBDG, transom lift devices “serve to reduce vessel drag by lifting the stern upward and reduce running trim angle, and total wetted surface. When running trim angle is reduced, then the flat of the bottom of the hull is better aligned with the direction of travel, and the required power to make speed is reduced.”

both the Parametric Weight Estimate and the Speed and Powering Calculations that the SF-BREEZE is less energy efficient on a per-passenger basis than the existing diesel ferry Vallejo.

3.1.5 Emissions of Greenhouse Gases and Criteria Pollutants

As discussed in Section 1.2, hydrogen has the potential to form the basis for a zero-carbon (and zero Greenhouse Gas (GHG)) energy system. This section assesses the real impact on GHG and criteria pollutant emissions of using hydrogen PEM fuel cell technology in the SF-BREEZE high-speed ferry application. GHG and criteria pollutant emissions are determined and directly compared with those from a conventional diesel-powered high-speed ferry to provide context. Figure 25 shows pictures and initial information for the SF-BREEZE and the *Vallejo*, a diesel-fueled ferry currently in service on the San Francisco Bay. The *Vallejo* was chosen as a comparison because it represents typical ferries in use around the world today and operates on a route that is well-characterized and appropriate for the SF-BREEZE. This choice in no way was intended to find fault with the Vallejo, the transit agency that operates it, or the public that supports it.

As described in Section 3.2, this study targets a “Subchapter T” vessel for the SF-BREEZE, which has a passenger limit of 150 passengers. Subchapter T regulatory requirements are somewhat relaxed compared to larger passenger vessels (regulated under Subchapter K), which was thought to facilitate design approval by U.S. Coast Guard and ABS. Although the *Vallejo* is a larger vessel, carrying twice the passengers as the SF-BREEZE, the two vessels can be compared for their GHG and criteria pollutant emissions on a per passenger basis.



SF-Breeze

Top Speed: 35 knots
Power Plant: PEM fuel cells
Fuel: Liquid Hydrogen
Passenger Capacity: 150



Vallejo

Top Speed: 35 knots
Power Plant: Two diesel engines
Fuel: Diesel
Passenger Capacity: 300

Figure 25: (Top): Engineering model for the SF-BREEZE. (Bottom): Photograph of the *Vallejo* ferry.

For this analysis, the Hydrogenics HD-30 fuel cell was adopted as representative of PEM fuel cells in general. Fuel cell selection is further described in Section 3.1.2. The HD-30 has a rated maximum power of 33 kW. Four HD-30 units are assembled per rack, giving a nominal rack power of 120 kW. With forty-one 120 kW racks onboard, the maximum power for the SF-BREEZE is 4,920 kW, with 4,400 kW propulsion power required to achieve 35-knot speed.

The *Vallejo* is powered by two MTU 16V4000 Diesel Engines [63] with a maximum power each of 1,700 kW, giving a total installed propulsion power of 3,400 kW. Both vessels are assumed to have a “hotel” or ship service power of 120 kW, which is needed for normal vessel electrical needs such as navigation, lights, and propulsion cooling systems for both vessels.

3.1.5.1 Vessel Energy

The GHG and criteria pollutant emissions analyses for the SF-BREEZE and the *Vallejo* are based on the energy expended by each vessel performing the same maritime mission, which is described fully in Section 3.1.1.

The information on the SF-BREEZE design generated by EBDG (see Section 3.1.4), public information about the *Vallejo* ferry, along with Figure 6 and Table 1 allow a calculation of the energy needed by both the SF-BREEZE and the *Vallejo* ferries to perform the Vallejo to San Francisco maritime mission. These energy calculations are shown in Table 6 and Table 7 for the SF-BREEZE and the *Vallejo* ferries, respectively, and form the basis for the GHG and criteria pollutant emissions estimates for these vessels. These energy estimates assume vessel operation in a quiescent sea state, but with a 13.5 knot head wind. No other energy margins are assumed. The SF-BREEZE energy requirements take into account the efficiencies of the electric drive components powered by the fuel cells, including DC-DC converters for power conditioning, DC-AC inverters and AC permanent magnet electric motors that provide shaft power. The propulsor (water jet) efficiency is also taken into account. See Appendix A for more details.

The current design of the SF-BREEZE allows it to travel at 35 knots using 4400 kW of fuel cell propulsion power. The total power demand on the fuel cells is the sum of the propulsion power plus the vessel hotel (service) power of 120 kW, making the maximal power demand during the San Francisco Bay crossing 4520 kW. The *Vallejo* ferry can achieve 35 knots with 3400 kW propulsion power. We assume the same 120 kW of service power for the *Vallejo* ferry as well, making its maximal total power consumption 3520 kW during 35 knot crossing of the San Francisco Bay. We presume that the extra 120 kW for the *Vallejo* is provided by a diesel auxiliary generator with the same thermal efficiency as the diesel engines.

Table 6: Vallejo to San Francisco Energy Requirements for the SF-BREEZE. The energy demands on the SF-BREEZE for performing each step of the Vallejo to San Francisco Ferry route are listed. The lower heating value (LHV) of the H₂ fuel needed to perform the step is also shown, which is a function of the fuel cell (FC) thermal efficiency appropriate for that step. The hydrogen LHV is 119.96 MJ/kg. The total engine energy (service energy + propulsion energy) needed for the one-way trip is 1.125×10^{10} J. The total hydrogen fuel energy (LHV) needed for the one-way trip is 2.39×10^{10} J.

SF-BREEZE Step	Duration (min)	Service Power (kW)	Propulsion Power (kW)	Total Energy for Step (J)	FC Efficiency for Step (%)	H ₂ LHV Needed (J)
Passenger Loading	5	120	0	3.60×10^7	53.3	6.75×10^7
Maneuvering	1.2	120	470	4.25×10^7	53.3	7.97×10^7
Mare Island Channel	12	120	1180	9.36×10^8	53.3	1.76×10^9
SF Bay Crossing	37.1	120	4400	1.01×10^{10}	46.6	2.17×10^{10}
Maneuvering at SF	3	120	470	1.06×10^8	53.3	1.99×10^8
Passenger Unloading	5	120	0	3.60×10^7	53.3	6.75×10^7

Table 7: The energy demands on the *Vallejo* ferry for performing each step of the Vallejo to San Francisco Ferry route. The lower heating value (LHV) of the diesel fuel needed to perform the step is also shown, which is a function of the diesel engine thermal efficiency appropriate for that step. The fossil diesel fuel LHV is 43.4 MJ/kg. The total engine energy (service energy + propulsion energy) needed for the one-way trip is 8.78×10^9 J. The total diesel fuel energy (LHV) needed for the one-way trip is 2.17×10^{10} J.

VALLEJO Step	Duration (min)	Service Power (kW)	Propulsion Power (kW)	Total Energy for Step (J)	Diesel Engine Efficiency for Step (%)	Diesel LHV Needed (J)
Passenger Loading	5	120	0	3.60×10^7	21.6	1.66×10^8
Maneuvering	1.2	120	363.3	3.48×10^7	28.7	1.21×10^8
Mare Island Channel	12	120	912.1	7.43×10^8	33.2	2.24×10^9
SF Bay Crossing	37.1	120	3400	7.84×10^9	41.9	1.87×10^{10}
Maneuvering at SF	3	120	363.3	8.70×10^7	28.7	3.03×10^8
Passenger Unloading	5	120	0	3.60×10^7	21.6	1.66×10^8

3.1.5.2 Power Plant Efficiencies

Table 6 and Table 7 list the total energy required for each step of the Vallejo-SF trip. In order to calculate the GHG and criteria pollutant emissions associated with vessel operation, the thermal efficiency of the power generating equipment must be known at various partial load states to calculate the fuel demand. Figure 26 gives the thermal efficiency, as a percentage of the LHV of the input fuel, for the PEM fuel cells and the diesel engines across their operating ranges. The figure assumes a LHV value of hydrogen of 119.96 MJ/kg, and a LHV value for diesel fuel of 43.4 MJ/kg. The PEM fuel cell data is from Hydrogenics specifications for the HD-30 PEM fuel cell [49, 50], which is the core fuel cell component for the SF-BREEZE PEM fuel cell power system. The HD-30 has a maximal power rating of 33 kW. The partial-load thermal efficiency of the MTU 16V4000 *Vallejo* diesel engine was not available, although its thermal efficiency at maximum power output can be inferred from the reported fuel consumption to be 41.9% [63]. For the purposes of Figure 26, we adopted a “typical” diesel generator dependence of efficiency on load level, pinning the 100% load efficiency at 41.9% [63].

The maximal efficiency of the PEM fuel cell is 53.3%, for a fuel cell power about 25% of the full rated power, or 8.25 kW in Figure 26. There are 164 HD-30 fuel cell units on the SF-BREEZE (41 fuel cell racks, with each rack holding four HD-30 fuel cell units). As a result, for any power demand greater than 8.25 kW and less than $164 \times 8.25 \text{ kW} = 1353 \text{ kW}$, the power load can be distributed amongst the fuel cells so that the optimal 53.3% efficiency is maintained. This is an important inherent advantage of having many fuel cells as opposed to a few large diesel engines – the number of fuel cells producing power can be

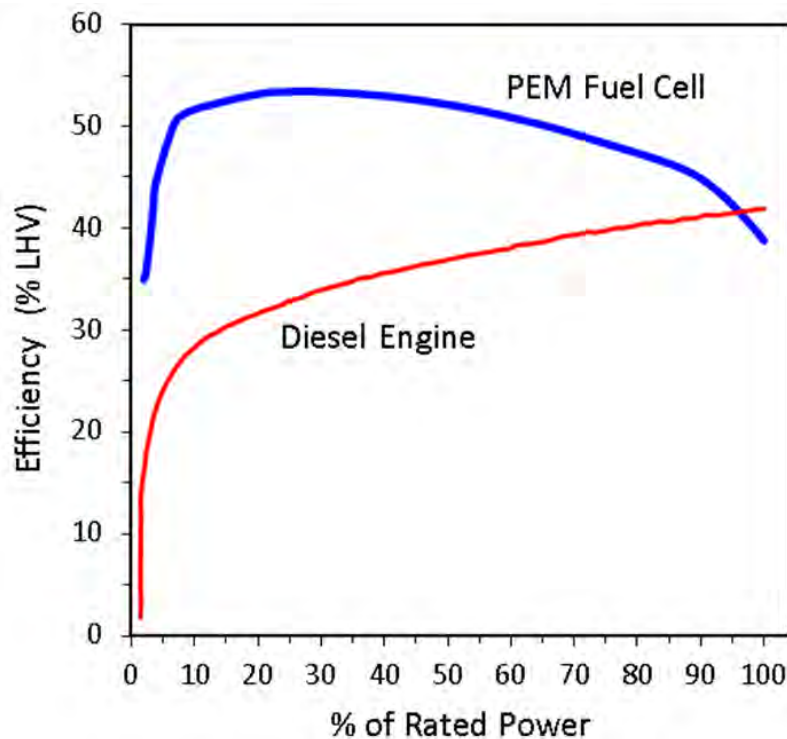

Figure 26: Thermal efficiency of the SF-BREEZE HD-30 PEM fuel cell (thick blue line) and the Vallejo’s MTU 16V4000 diesel engine (thin red line) as a function of the partial load. For the HD-30, the maximal power (100% load) is 33 kW. For one of the MTU 16V4000 diesel engines, the maximal power is 1700 kW. The figure assumes a LHV value of hydrogen of 119.96 MJ/kg, and a LHV value for diesel fuel of 43.4 MJ/kg.

controlled. At part load, the operator can choose to use more cells at lower power to achieve maximal efficiency and reduce fuel cost, or can choose to operate fewer cells at higher power to reduce the number of hours each cell operates on average.

As shown in Table 6, for all trip steps except for the San Francisco Bay Crossing, the fuel cells operate at the maximal efficiency of 53.3%. For total power loads greater than 1353 kW, there is a steady decline in PEM fuel cell thermal efficiency suggested by Figure 26. At full SF-BREEZE power, required for the SF-Bay crossing, the fuel cell thermal efficiency is 46.6% with all the fuel cells sharing the power equally.

This fuel cell power distribution architecture is conceptually different than that of the *Vallejo*. With two diesel engines on the *Vallejo* driving the water jets independently of each other, for any given propulsion power, the propulsion load is assumed to be split evenly between the two diesel engines for the vessel to track in a straight line (except for low power maneuvering of the vessel in port). Thus, during operation at less than maximal load, the two diesel engines are operating at the same sub-maximal thermal efficiencies listed in Table 7. The highest diesel engine efficiency, 41.9%, is achieved for the SF-Bay crossing. Table 6 and Table 7 show that the crossing of San Francisco Bay consumes the vast majority of the energy needed for this maritime mission. For the SF-BREEZE, the crossing requires 89.7% of the total mission energy; for the *Vallejo*, the percentage is 89.3%. Thus, the SF Bay crossing drives ~ 90% of the GHG and criteria pollutant emissions from these vessels during the voyage. The total fuel energy required for the trip, combined with the LHV numbers for the two fuels allows a calculation of the total fuel consumption for each vessel. For the SF-BREEZE, the total hydrogen fuel energy (LHV) devoted to the voyage is 2.39×10^{10} J. Using the hydrogen LHV of 119.96 MJ/kg, we calculate the total LH₂ consumption per trip to be 199.2 kg. For the *Vallejo*, the total diesel fuel LHV energy required for the trip is 2.17×10^{10} J. Using the diesel LHV of 43.4 MJ/kg, and the density of diesel fuel = 0.832 kg/L, we calculate the total diesel fuel consumption per trip is 500.0 kg, or 601.0 L (158.8 gallons).

Note that the total fuel energy (on a LHV basis) required for the SF-BREEZE is 10.1% more than for the *Vallejo*. This is a consequence of the SF-BREEZE being heavier. Despite the fact that hydrogen is the lightest fuel, the weights of the fuel cell power racks, liquid hydrogen tank, evaporator and other balance of plant items are heavier than the two diesel engines with their associated balance of plant. Although the fuel cells on the SF-BREEZE are more efficient than the two diesel engines on the *Vallejo*, the higher weight tips the fuel energy consumption balance in favor of the *Vallejo*. Next we calculate the GHG and criteria emission consequences of this fuel use on the two vessels.

3.1.5.3 Results: GHG Emissions

Water is the only product of PEM fuel cell operation. There is no formation of CO₂, NO_x, SO_x, or particulate matter (PM), making the PEM fuel cell a zero-emissions power plant. As a result, the GHG emissions associated with SF-BREEZE consist entirely of the emissions associated with the production and transport of LH₂ to the vessel. This fuel pathway is referred to as “well-to-tank” (WTT). Analogously, GHG emissions are associated with the production and delivery of diesel fuel. If the diesel fuel originates from petroleum, then there is the additional GHG emissions associated with releasing CO₂ upon combustion. As a result, GHG emissions from the *Vallejo* involve two sources: the WTT production and delivery of the diesel fuel, and combustion of the fuel assuming the diesel is derived

from petroleum. For light-duty vehicles, this entire pathway is referred to as “well to wheels” as it includes combustion of the fuel onboard the vehicle. For our maritime application, we refer to this pathway as “well to waves” (WTT).

Our GHG estimates rely on the WTT GHG analysis conducted by the European commission for automotive fuels in 2007 [64], which were updated in 2013 [65]. We chose this study because its authors come from a variety of stakeholders including automakers (Ford, Renault, Volvo, Fiat, etc.), energy companies (Exxon/Mobile, BP, Shell, etc.) and environmental experts from across the EU. In addition, the study considered a wide variety of pathways (both fossil fuel and renewable) for generating hydrogen. There is also a greater cumulative experience with diverse energy pathways in Europe than elsewhere in the world, which provides confidence in the study results.

As described in Reference [64], the WTT analysis considers the process of producing, transporting, manufacturing and distributing a number of fuels, including hydrogen, diesel, and biodiesel fuel. The study covers all steps in producing and delivering a final fuel product to the storage tank of an end use (vehicle, vessel) with the steps defining a WTT pathway. Energy costs and GHG emissions are assessed along various fuel production/delivery pathways. The study assumes the infrastructure for fuel production and delivery already exists, hence it does not consider GHG emissions associated with construction or decommissioning of plants. It turns out the GHG contributions from these infrastructures are relatively small and within the uncertainty of the estimates. For fuels of biomass origin, such as biodiesel or hydrogen from wood gasification, the predicted GHG emissions do not include emissions caused by land use change, but do include N₂O emissions from use of fertilizer and N₂O release from agricultural lands.

There are 4 general categories defining a WTT pathway:

Production and Conditioning at Source: Generally a fuel can be produced from a number of different primary energy sources, obtained by extraction (as in hydrocarbons or fissile material for nuclear power), capture (as in solar or wind), or growing (as in biomass). The *Production and Conditioning at Source* category captures all operations required to extract, capture or cultivate the primary energy source at its point of capture. For example, petroleum needs to be extracted from the ground. Typically this is done using the natural pressure of the oil field, but it can also require deliberate gas injection to boost pressure. The extracted or harvested energy primary energy carrier typically requires some form of treatment or conditioning before it can be safely transported elsewhere. For example, water may need to be separated out. The energy and GHG emissions associated with such operations at the source are examined in the EU Commission study in this category.

Transportation to Processing Plant: This category captures the transportation of the primary energy carrier to the processing plant where the primary energy carrier is refined into finished fuel. Since this refining is typically not conducted near the source, the transportation distances can be quite long. For natural gas (NG), transportation represents the largest energy requirement. Western Siberian fields are ~ 7000 km from Europe. Pipelines require compression stations at regular intervals along the transport path, consuming energy and producing associated GHG emissions. Leakage in NG pipelines also

represents a transportation pathway source of GHG emissions. This has direct relevance for hydrogen, as steam methane reforming (SMR) of NG is currently the dominant method of producing hydrogen.

Processing at Plant: This category captures the energy and GHG emissions involved in processing and transforming the product into a final fuel to an agreed upon specification near the final market. For the example of hydrogen generation from NG, steam methane reforming takes place at the processing plant and requires significant energy input to produce the furnace temperatures (~ 900 °C) needed for the reformation process. Furthermore, if the hydrogen needs to be liquefied (as it does for the SF-BREEZE), liquefaction also takes place at the centralized plant and involves significant energy input with associated GHG emissions.

Distribution: This category captures the energy and GHG emissions associated with transport to the final customer end use. For NG, distribution is made via an extensive pipeline distribution network. Hydrogen can also be delivered by pipeline, but for delivery to hydrogen stations serving light-duty fuel cell vehicles, or a hydrogen station serving the SF-BREEZE, the hydrogen will initially be delivered by road tanker carrying LH₂. For some light-duty vehicle hydrogen stations, hydrogen is delivered as a compressed gas.

The major GHGs accounted for in the study are carbon dioxide (CO₂), methane (CH₄) and nitrous oxide (N₂O). The results are expressed as “CO₂ equivalence” (CO₂ (eq.)) and each gas is assigned a CO₂ (eq.) “weighting factor.” CO₂ has a weighting factor of 1, whereas CH₄ has a factor of 23 and N₂O has a weighting factor of 296. Thus methane is 23 times more potent a GHG than carbon dioxide, which makes NG leakage a significant concern for GHG emissions associated with NG transport. Carbon dioxide is produced in gigantic quantities by combustion of fossil fuels. Nitrous oxide emission derives primarily from nitrogen fertilizer production and release from open agricultural fields. Although produced in relatively smaller amounts, N₂O is an important GHG because of its very large weighting factor of 296. In contrast to CO₂, CH₄, and N₂O, H₂ is not a GHG, so leaks of hydrogen, while an economic loss, have no environmental impact.

The LH₂ WTT pathways considered in this study are depicted in Figure 27. Approximately 90% of the hydrogen used today comes from the steam reforming of fossil NG. Steam methane reforming to LH₂ is identified in the EU Commission study as pathway GPLH1b. The NG is conditioned at the source, transported via NG pipeline 4000 km, reformed at a central reforming facility, liquefied at the plant, and then transported as a liquid in a road tanker a distance of 300 km. Since all of the carbon in fossil-based NG is released into the atmosphere during pathway GPLH1b, we anticipate large GHG emissions from the SF-BREEZE using LH₂ from this pathway.

A second LH₂ production pathway is electrolysis of water using grid power, in this case, the grid mix of the European Union. This pathway is indicated in Figure 27, and identified in the EU Commission report as pathway EMEL1/LH1. Table 8 compares the 2007 EU grid mix assumed for the study [64], and that of the State of California in 2014 [66]. There are distinct differences between the two grid mixes. The EU has more low-carbon nuclear, while the State of CA has considerably less high-carbon coal. The State of CA has more low-carbon wind, but less zero-carbon hydroelectric power. Overall, we judge these two

LH₂ from Fossil NG (GPLH1b):

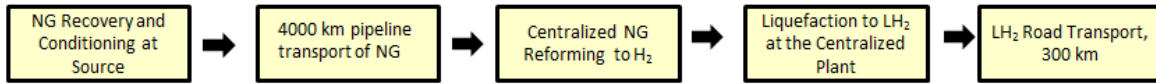

Conventional Electrolysis (EMEL1/LH1):

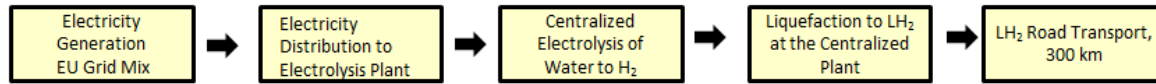

Renewable Pathways:

LH₂ from Wood Gasification (WFLH1):

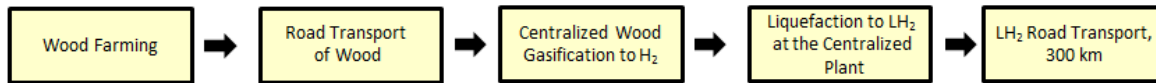

LH₂ from Wind Electrolysis of Water (Modification to WDEL1/CH2):

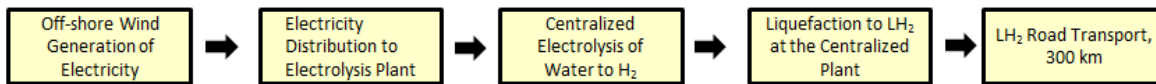

LH₂ from Nuclear Power Electrolysis of Water (Modification to NUEL/CH1):

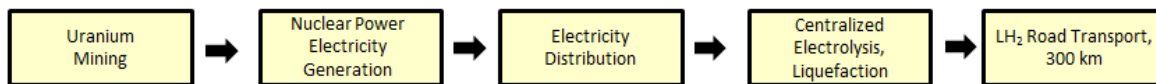

Figure 27: WTT LH₂ pathways considered in the GHG analysis of the SF-BREEZE and Vallejo Ferries. Pathway codes in parenthesis identify the pathway describe in detail in the European Commission [64, 65].

grid mixes to be comparable as bases for GHG calculations. More recent assessments of the EU grid mix in 2013 show only small variations from the grid mix of 2007 [65].

Table 8: A comparison of the 2007 EU grid mix assumed in the studies of Reference [64] with the 2014 State of California grid mix described in Reference [66].

Grid Resource	2007 EU Mix (%)	2014 State of CA (%)
Nuclear	37.5	8.5
Coal	22.4	6.4
Oil	9.6	0
Natural Gas	15.5	44.5
Hydroelectric	12.4	5.5
Wind	0.4	8.1
Waste	1.8	2.5
Other Renewables	0.3	9.5
Other	0.1	15

“Renewable Pathways” of hydrogen production are those that don’t involve the release of carbon, or if carbon is released, then it came recently from CO₂ in the air, making the pathway “carbon neutral.” The EU commission studies [64, 65] incorporated one renewable pathway that led directly to LH₂, namely wood gasification (WFLH1). Other renewable pathways to hydrogen include using offshore wind to electrolyze water (WDEL1/CH2) and using nuclear generated electricity to electrolyze water (NUEL/CH1), as depicted in Figure 27. For these later two pathways, compressed hydrogen gas was produced, not LH₂. To estimate a GHG emission number for the pathway that would have led to LH₂, we modified the path to include a hydrogen liquefaction step, and increased the GHG emissions reported by the EU commission for the renewable compressed hydrogen product by a factor of 1.286 to reflect increased emissions associated with liquefaction using renewable energy. This factor was determined by taking the ratio of the GHG emissions reported for making LH₂ by fossil NG reforming (GPLH1b), 126.3 g CO₂ (eq.)/MJ_{fuel} to the GHG emissions reported for making compressed hydrogen by fossil NG reforming (GPCH2b), 98.2 g CO₂ (eq.)/MJ_{fuel}. That ratio is 1.286 and is used to correct renewable pathway GHG emission reported for compressed gas to obtain the GHG emission for producing LH₂ via the same production method.

The results for the EU Commission report for total WTT GHG emissions in CO₂ (eq.) for the LH₂ production pathways of Figure 27 are reported in Figure 28. Only the total GHG figure is given. The EU Commission report [64] can be consulted for the breakdown in the GHG emissions according to each

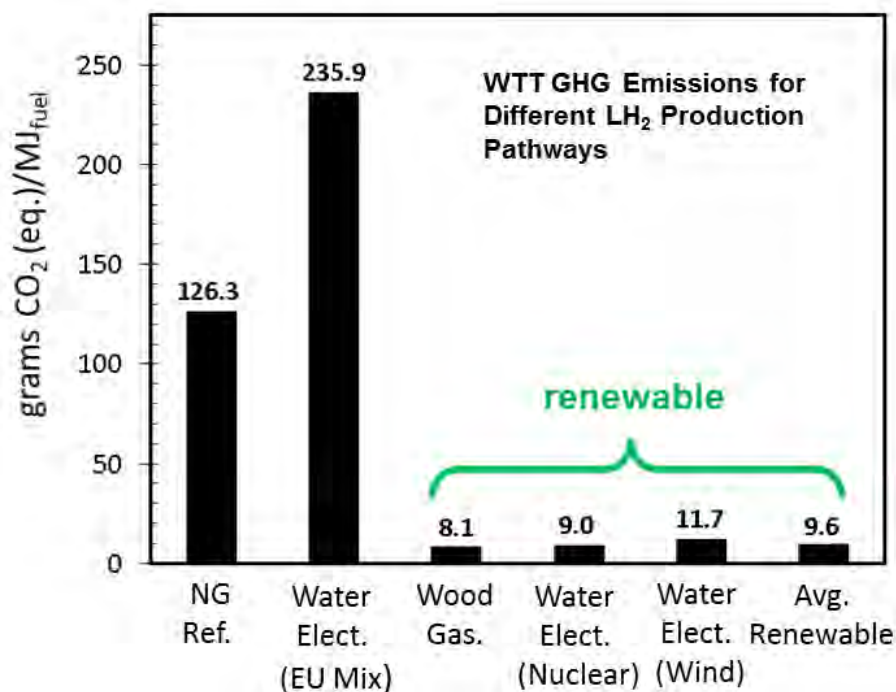

Figure 28: Total fuel pathway (WTT) GHG emissions in grams CO₂ (eq.)/MJ_{fuel} for the LH₂ production pathways considered in this study: (L-R); NG reforming, electrolysis of water using the EU grid mix, wood gasification, water electrolysis using nuclear-based electricity, water electrolysis using wind-based electricity, and the average of the renewable paths. The figure reports the GHG emissions associated with producing one MJ of finished fuel on a LHV basis, MJ_{fuel}. GHG emissions in units of grams CO₂ (eq.)/MJ_{fuel} are given for the LH₂ production pathways considered in this study. The figures report the GHG emissions associated with producing one MJ of finished fuel on a LHV basis, MJ_{fuel}.

pathway step (production at source, transportation to processing plant, processing to fuel, and fuel transport to market).

Figure 28 shows that the current commercial method of making LH₂, namely NG reforming to hydrogen followed by liquefaction (GPLH1b) produces 126.3 grams of CO₂ (eq.) per megajoule of LH₂ on a LHV basis. Recall that the LHV of hydrogen is 119.96 MJ/kg. Thus, 15.1 kg of CO₂ (eq.) emissions are released in the production of 1 kg of LH₂.

Water electrolysis using conventional grid power comprised of the EU mix produces 235.9 grams of CO₂ (eq.)/MJ fuel, significantly worse than the fossil NG reforming route. This is because water electrolysis is very energy intensive. The EU Commission reports that it takes 1.13 MJ of process energy for every 1.0 MJ of LH₂ fuel produced by NG reforming. In contrast, it takes 4.22 MJ of process energy to make 1.0 MJ of LH₂ via water electrolysis. Thus, if the current carbon-rich electrical grid is used to perform the electrolysis, LH₂ production via water electrolysis is not competitive from a GHG perspective with steam methane reforming. We will not consider water electrolysis via the grid further, but will assess its GHG and criteria pollutant emissions when low-carbon (renewable) sources of electricity are available.

Figure 28 shows that when renewable sources of hydrogen are available, then fuel pathway GHG emissions are dramatically reduced. Wood gasification (WFLH1) yields 8.1 grams of CO₂(eq.) for every 1.0 MJ (LHV) of LH₂. Electrolysis of water using low-carbon electricity sources such as nuclear power or wind also yield very low GHG emission values of 9.0 and 11.7 g CO₂ (eq.)/MJ_{fuel}, respectively. Taking the average of these renewable paths, we get an average renewable GHG emissions for the production and delivery of renewable LH₂ as 9.6 grams CO₂(eq.)/MJ_{fuel}. Since PEM fuel cells produce no emissions of any kind at the point of use, these WTT LH₂ production numbers provide the entire basis for estimating GHG emissions from the SF-BREEZE. In other words, since the PEM fuel cell is zero emissions, the WTT emissions equal the WTW emissions.

In contrast, the use of diesel fuel on the *Vallejo* has two components of GHG emission. The first component lies in the production and delivery of diesel fuel. The EU Commission study reports that GHG emissions associated with diesel production is 14.2 g CO₂ (eq.)/MJ_{fuel}. Recalling the LHV of diesel is 43.4 MJ/kg, and noting the density of diesel fuel is 0.832 kg/L, making one gallon of diesel fuel releases 1.94 kg CO₂ (eq.) per gallon produced. This figure is significantly less than the 15.1 kg of CO₂ (eq.) emissions released in the production of 1 kg of LH₂ by fossil NG reforming. The emissions for manufacture of diesel fuel are less because there is dramatically less process energy used in refining petroleum to diesel fuel than in steam reforming NG to hydrogen. The EU Commission reports that it takes 0.16 MJ of process energy to make 1.0 MJ of diesel fuel. This can be compared to the 1.13 MJ of process energy it takes to make 1.0 MJ of LH₂ fuel by NG reforming. Only a portion of the process energy is tied up in liquefaction of hydrogen. The EU reports that to make and deliver 1.0 MJ of hydrogen compressed to 880 bar (pathway GPCH2b) still requires 0.72 MJ of process energy. Summarizing, making LH₂ is very energy intensive compared to making diesel fuel, even when using the least-energy-intensive pathway for making hydrogen, namely steam reforming of fossil NG.

Since the carbon atoms in fossil diesel fuel came from the atmosphere millions of years ago, its combustion represents a significant addition to CO₂ already in the atmosphere. The EU commission reports that burning diesel fuel produces 73.2 g CO₂ (eq.)/MJ_{fuel}. This is nearly all produced as CO₂, assuming the average chemical formula for diesel fuel is C₁₂H₂₃. Thus, the total WTW GHG emissions from making and burning (to completion) 1.0 MJ (LHV) of fossil-derived diesel fuel is 14.2 g CO₂ (eq.) + 73.2 g CO₂ (eq.) = 87.4 g CO₂ (eq.)/MJ_{fuel}.

We consider “biodiesel fuel,” specifically fatty acid methyl ester (FAME), to be the “renewable” fuel that could be used in the Vallejo. Since biodiesel could be to first approximation a “drop in” fuel for the Vallejo, we can consider the impact of fueling the Vallejo with a renewable biodiesel because we don’t anticipate there would be dramatic changes to the engines, fuel tanks, fueling systems or passenger capacity. With the hardware, weight and passenger allotment of the vessel remaining the same, we can use the same values of “step energy” shown in Table 7 to assess GHG emission for the Vallejo running on biodiesel.

The EU Commission reports [64, 65] the energy and GHG emissions associated with making and delivering biodiesel fuel, with the most updated figures from the 2013 Report [65]. In Europe, biodiesel is mostly produced from rapeseed with some production using sunflower seeds as the feedstock. Since the carbon in these living materials came recently from atmospheric CO₂, burning biodiesel with CO₂ release is considered carbon neutral, and the WTW GHG emissions equal the WTT GHG emissions for biodiesel. However, the WTT GHG emissions for making and delivering biodiesel are not zero, since significant process energy is needed for farming the seeds and converting the biomass to fuel. Making biofuels from these seeds takes 1.20 MJ of process energy for every megajoule of biodiesel fuel produced. This is 7.5 times more process energy than it takes to make the energy equivalent of diesel fuel from petroleum (0.16 MJ/MJ_{fuel}). The WTT GHG emissions associated with making biodiesel fuel by the rapeseed and sunflower pathways is (taking the average of the two feedstocks) 55.0 g CO₂ (eq.)/MJ_{fuel}. [65] Although burning biodiesel does not release net CO₂, criteria pollutants are created, such as NO_x, HC and PM.

With this information in hand about the WTT GHG emissions associated with making and delivering LH₂ via the pathways of Figure 27, the WTT GHG emissions associated with making and delivering fossil diesel and biodiesel, as well as the GHG emissions associated with burning fossil diesel, we can now assess the well-to-waves GHG emissions from both the SF-BREEZE and the *Vallejo* in travelling from Vallejo CA to San Francisco CA. The results are shown in Figure 29.

Figure 29 shows that the WTW GHG emissions from the SF-BREEZE fueled with LH₂ from fossil NG would be 20.12 kg CO₂ (eq.)/passenger/trip, produced entirely during the production and delivery of the LH₂ fuel. This is significantly worse than the *Vallejo* running on fossil diesel, with WTW GHG emissions of 6.32 kg CO₂ (eq.)/passenger/trip. The reasons for this increase are that the SF-BREEZE carries half the number of passengers as the *Vallejo* and also requires more fuel energy. Since the GHG results are normalized to the number of passengers, this produces a factor-of-two increase for the SF-BREEZE GHG emissions based on passenger capacity alone. Further increases in the GHG emissions come from the fact that making hydrogen is energy intensive in the first place, and hydrogen liquefaction involves

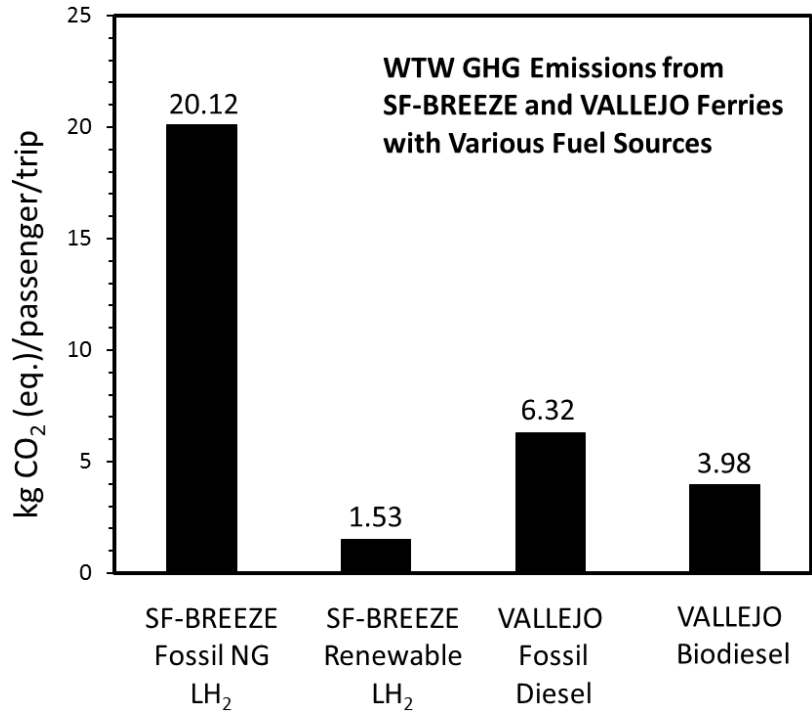

Figure 29: Predicted well-to-waves (WTW) GHG emissions per passenger for the SF-BREEZE and the *Vallejo* for the Vallejo-San Francisco route described in Figure 5 and Figure 6 and in Table 1. Emissions are given based on a one-way trip. Note the change in vertical scale units from Figure 28 to Figure 29, from grams CO₂ (eq.) (Figure 28) to kilograms CO₂ (eq.) (Figure 29).

significant energy and associated GHG emissions. Thus, the reduced passenger count, the higher fuel energy consumption, and GHG penalties associated with making hydrogen from fossil NG and liquefying it, produce undesirable GHG emissions for the SF-BREEZE along the fuel production and delivery path.

The situation is dramatically improved using renewable hydrogen. Taking the average value of the renewable production pathways, 9.6 g CO₂ (eq.)/MJfuel in Figure 28, Figure 29 shows the WTW GHG emissions from the SF-BREEZE per passenger for a one-way trip from Vallejo to San Francisco using renewable LH₂ becomes 1.53 kg CO₂ (eq.)/passenger/trip. This is 75.8% less than the WTW GHG emissions from the *Vallejo* running on conventional diesel fuel on a per passenger, per trip basis.

Figure 28 and Figure 29 show that the real potential in hydrogen technology to reduce GHG lies NOT in the use of hydrogen derived from fossil NG, but rather in using renewable hydrogen. The renewable hydrogen considered for Figure 28 and Figure 29 is nearly 100% renewable. In California, the current mandate is that all state-funded hydrogen stations being built in the State for light-duty fuel-cell vehicles need to provide hydrogen that is at least 33% renewable. That percentage must increase significantly to make the cuts in GHG emissions needed to properly address global climate change. In our discussions with the gas suppliers, renewable LH₂ can be made available to the SF-BREEZE today (see Section 4.1.4). The major gas suppliers are currently working to make renewable hydrogen more broadly available.

One could consider using biodiesel as a drop-in renewable fuel for the *Vallejo*. Figure 29 shows that the well-to-waves GHG emissions are indeed reduced, from 6.32 kg CO₂ (eq.)/passenger/trip for diesel fuel to 3.98 kg CO₂ (eq.)/passenger/trip for biodiesel. This represents a 37% reduction in GHG emissions. The

analysis does not take into account that more biodiesel would have to be stored on the *Vallejo* because the LHV of biodiesel is ~ 37 MJ/kg [67], down from 43.4 MJ/kg for diesel fuel. The extra biodiesel fuel needing to be stored would increase the weight of the *Vallejo*, increasing the energy demand for the trip from Vallejo to San Francisco. Also, we note here that the biodiesel results in Figure 29 are for the particular FAME biodiesel production paths considered in Ref. [65]. Biodiesel production paths can vary considerably, especially with regard to the fertilizer and water requirements. The WTW GHG emissions for a particular biodiesel pathway differing from those of Ref. [65] would have to be evaluated separately.

Traditional biodiesel is the fatty acid methyl ester product that results from the transesterification of vegetable oil or animal fats with methanol. The oils themselves are not compatible with diesel engine operation due to their higher viscosities, thus requiring the transesterification processing. In the ~ 2010 timeframe, there emerged alternative methods of oil processing that produced fuels whose composition more closely resembled fossil diesel. These products are called “renewable diesel” or “green diesel” [26].[68] Renewable diesel is produced primarily by “hydrodeoxygenation” in which the oil or fat feedstock is treated with hydrogen at elevated temperatures and pressures to produce long chain alkanes (not the esters of biodiesel) that resemble the components of fossil diesel fuel. In Europe, the product is called “hydrotreated vegetable oil” (HVO).[65] The 2013 EU commission study [65] reports that the WTT GHG emissions (grams CO_2 (eq.)/MJ_{fuel}) for HVO and biodiesel are essentially the same. This means that the WTW GHG emissions for the VALLEJO ferry operating on renewable diesel would be essentially the same as that depicted in Figure 29 for biodiesel.

Summarizing the GHG results of Figure 29, hydrogen PEM fuel cell technology can dramatically reduce the GHG emissions from high-speed ferry operations. However, nearly 100% renewable hydrogen must be used to achieve the desired deep cuts (76%) in GHG emissions that are commensurate with the challenge presented by global climate change.

3.1.5.4 Results: Criteria Pollutant Emissions

Criteria pollutant emissions from the combustion of fossil fuels, among them nitrogen oxides (NO_x), hydrocarbons (HC) and particulate matter (PM) continues to be of concern due to their immediate adverse health effects. Since the PEM fuel cell does not involve combustion, it is incapable of producing criteria pollutants at the point of use. As a result, any criteria pollutant emissions associated with the SF-BREEZE arise entirely from emissions associated with the production and transport of LH_2 to the vessel, namely the WTT criteria pollutant emissions. Criteria pollutant emissions can arise from combustion used to create the process heat needed to heat the reactants of the SMR process or as a byproduct of the SMR process. Alternatively, combustion could be used to generate the electricity used in hydrogen liquefaction.

Analogously, criteria pollutant emissions are associated with the production and delivery of diesel fuel. For example, the diesel-fueled tanker truck delivering diesel fuel is a source of diesel pathway criteria pollutant emissions. If the diesel fuel originates from petroleum (“fossil diesel”), then there is the additional criteria pollutant emissions associated with burning the fuel in the ferry diesel engines. As a result, criteria pollutant emissions from a diesel-powered vessel using fossil diesel fuel involve two

sources: (1) production and delivery of the diesel fuel and (2) combustion of the fuel onboard the vessel. If the diesel fuel originates from biomass (“biodiesel”), there are still criteria pollutant emissions released on the vessel, even though biodiesel reduces GHG emissions because the carbon released on the vessel originated recently from CO₂ in the air.

The European commission WTT analysis for automotive fuels in 2007 [64], updated in 2013 [65], were used as the basis for our GHG analysis. However, these studies did not provide information on criteria pollutant WTT emissions. For WTT fuel pathway criteria pollutant emissions, we use a 2007 analysis conducted by Unnasch and Pont of TIAX LLC for the California Energy Commission (CEC).[69]

The TIAX WTT study provides estimates for criteria pollutant emissions based on the energy consumption of various fuel paths, including the production and delivery of LH₂, diesel fuel and biodiesel. Combustion energy consumption is the principle source of criteria emission in these fuel pathways. The study reports emissions from the perspective of exposure to an individual in California, and thus is somewhat California specific. For example the electricity grid mix employed was that of California, and California emissions standards on stationary equipment were assumed.[69] This is an advantage of the analysis for the present purposes as we consider the case of the SF-BREEZE operating in the San Francisco Bay in Northern California.

The TIAX study generally follows the spirit of the pathways indicated in Figure 27. The pathway for production of LH₂ from fossil NG is similar to that in Figure 27 (labeled GPLH1b from the European Commission study), except that the distance for LH₂ road transport was assumed to be 80.5 km (50 miles) instead of 300 km. The renewable pathways for LH₂ production shown in Figure 27, namely wood gasification, wind electrolysis of water and nuclear power electrolysis of water, were not considered in the TIAX criteria pollutant emissions analyses. However, there was an analysis performed for criteria emissions associated with conventional water electrolysis (labeled EMEL1/CH1 from the European Commission study) producing gaseous hydrogen using 70% renewable power at an on-site facility (i.e. no road transport). We multiply the criteria pollutant emissions for this 70% renewable path by the factor 1.286 to account for emissions associated with liquefaction using renewable energy, and also add emissions associated with tanker transport of the LH₂ over a distance of 80.5 km. We adopt this revised pathway to represent criteria pollutant emissions associated with “70% Renewable LH₂.”

Table 9 reports the WTT criteria pollutant emissions associated with the fuel pathways for LH₂ produced by steam methane reforming of fossil NG, 70% renewable LH₂, fossil diesel fuel and biodiesel. The results are reported in terms of grams of pollutant emitted per gigajoule (LHV) of the fuel energy.

The “Fossil NG LH₂ Fuel Pathway” has sizeable criteria pollutant emissions. This is due to the use of combustion (typically of NG) to heat the SMR reactor to the required ~ 900 °C. In addition, combustion is used to provide electricity for the process equipment via the California grid (of which 50.9% is derived from burning NG or coal, see Table 10), and combustion is used to power the LH₂ tanker truck as it drives 80.5 km in delivering LH₂. In the TIAX study [69] it was noted for this fuel pathway that there exists somewhat high PM emissions for natural gas combined cycle power plants which constitute 44.5%

Table 9: WTT criteria pollutant emissions for fuel pathways on a LHV basis. GJ_{fuel} represents the lower heating value (LHV) of the indicated fuel in gigajoules (GJ). $1\text{ GJ} = 1 \times 10^9\text{ J}$.

Fuel Pathway	NO_x (g/ GJ_{fuel})	HC (g/ GJ_{fuel})	PM (g/ GJ_{fuel})
Fossil NG LH₂ Fuel Pathway	45.0	3.5	5.0
70% Renewable LH₂ Fuel Pathway	2.1	2.0	3.9
Fossil Diesel Fuel Pathway	1.4	3.5	0.06
Biodiesel Fuel Pathway	4.5	3.4	0.18

of the California grid mix. The origin is not the increased (~ 2x) PM emissions associated with LH₂ trailer transport compared to diesel fuel transport.[69] Indeed, the PM release from trailer transport of 4000 kg of LH₂ a distance of 80.5 km is predicted [69] to be only 0.029 g/ GJ_{fuel} ; ~0.6% of the overall WTT PM emissions of 5.0 g/ GJ_{fuel} for the Fossil NG LH₂ Fuel Pathway reported in Table 9. It is the energy intensity of hydrogen production, not transport, which drives the associated WTT criteria pollutant emissions.

The “70% Renewable LH₂ Fuel Pathway” has substantially reduced NO_x emissions because the electrolysis of water does not require the high process heat of the SMR production method. However, as stated previously, electrolysis of water is very energy intensive. Recall that it takes 4.22 MJ of process energy to make 1.0 MJ of LH₂ (LHV) via water electrolysis. The 30% of the energy that is not renewable (fossil-fuel based), combined with the large requirement for electrolysis process energy, produce non-zero amounts of NO_x, HC and PM emissions per GJ_{fuel} , as shown in Table 9.

Table 9 also lists the WTT criteria pollutants associated with making and delivering fossil diesel and biodiesel. The criteria pollutant emissions for biodiesel are generally higher than for fossil diesel because of the increased process energy needed to make biodiesel fuel, as mentioned earlier.

Using these values in Table 9, we can calculate the fuel pathway (WTT) criteria pollutant emissions on a per passenger per trip basis for the SF-BREEZE and again compare to the Vallejo diesel ferry. We do this by combining the WTT criteria pollutant emission values in Table V with the vessel energy use numbers for the SF-BREEZE and the Vallejo reported in Table 6 and Table 7, respectively. These results are shown in Table 10 for the SF-BREEZE and the Vallejo. Well-to-waves (WTW) criteria pollutant emissions (pathway + engine) for the SF-BREEZE are equal to the LH₂ well-to-tank (WTT) fuel pathway emissions because the PEM fuel cell criteria pollutant emissions are zero. The results for WTW criteria pollutant emissions shown in Table 10 are presented graphically in Figure 30.

For Table 10 and Figure 30, we constrain both the diesel and biodiesel engine emissions of the *Vallejo* to be at the Tier 4 criteria pollutant emission limits. In this way, we are comparing the SF-BREEZE to a new vessel build (one based on either fossil diesel or biodiesel) which must meet the Tier 4 limits by regulation. This is not to say that the emissions from fossil diesel and biodiesel would be the same if

Table 10: Fuel pathway (WTT) criteria pollutant emissions and well-to-waves (pathway + engine, WTW) emissions on a grams per passenger/trip basis calculated for the SF-BREEZE and the *Vallejo* for the Vallejo to San Francisco route of Figure 5. The SF-BREEZE carries 150 passengers, while the *Vallejo* carries 300 passengers. The engine criteria pollutant emissions of the *Vallejo* are set to the Tier 4 limits for both fossil diesel and biodiesel operation.

	NO _x (g/passenger/trip)	HC (g/passenger/trip)	PM (g/passenger/trip)
SF-BREEZE Fossil NG LH₂ Fuel Pathway	7.17	0.557	0.796
SF-BREEZE 70% Renewable LH₂ Fuel Pathway	0.338	0.321	0.620
SF-BREEZE Fuel Cell Engine	0.00	0.00	0.00
SF-BREEZE Fossil NG LH₂ Total (Pathway + Engine)	7.17	0.557	0.796
SF-BREEZE 70% Renewable LH₂ Total (Pathway + Engine)	0.338	0.321	0.620
Diesel Fuel Pathway	0.101	0.253	0.00433
Biodiesel Fuel Pathway	0.322	0.246	0.0130
<i>Vallejo</i> Tier 4 Engine	14.63	1.54	0.325
<i>Vallejo</i> Tier 4 Diesel Total (Pathway + Engine)	14.73	1.79	0.329
<i>Vallejo</i> Tier 4 Biodiesel Total (Pathway + Engine)	14.95	1.79	0.338

burned in the same engine. Indeed, as reviewed by Knothe [68], biodiesel releases ~ 12% more NO_x compared to fossil diesel, but produces substantially (50 – 70%) less HC and PM than fossil diesel when burned in the same engine.

While the hydrogen PEM fuel cell technology automatically satisfies the Tier 4 criteria emission requirements because it is zero-emission technology at the point of use, the WTW analysis captures important fuel production pathway and delivery emissions.

The first aspect of Figure 30 to notice is that the WTW criteria pollutant emissions for the *Vallejo* running on diesel fuel or biodiesel are very nearly the same. Although the WTT criteria pollutant emissions for the production and delivery of biodiesel are higher than those for fossil diesel (see Table 10) due to the increased process energy required, the WTT criteria pollutant emissions are only a small fraction of the overall WTW criteria pollutant emissions, as indicated in Table 10. This finding, combined with the onboard criteria emissions for the *Vallejo* running on fossil diesel or biodiesel set equal to each other at the Tier 4 limits, produces the similarity for these fuels seen in Figure 30.

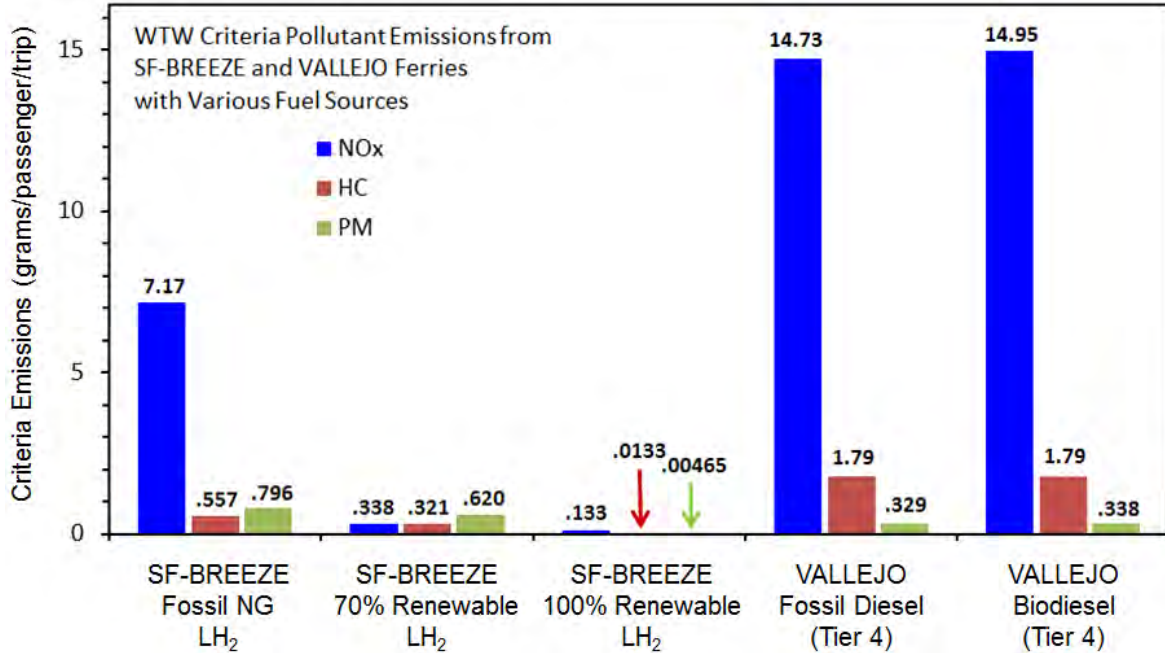

Figure 30: Predicted well-to-waves (WTW) criteria pollutant emissions per passenger for the SF-BREEZE and the *Vallejo* on the Vallejo-San Francisco route described in Figure 5 and Figure 6 and in Table 1. Emissions are given based on a one-way trip. The SF-BREEZE carries 150 passengers, while the *Vallejo* carries 300 passengers. The *Vallejo* engine emissions are set equal to the Tier 4 limits for both fossil diesel and biodiesel operation.

The TIAX report [69] did not examine criteria emissions from renewable diesel¹⁵ because it was a barely emerging technology at the time of the report. There have been no published analyses of the WTT criteria pollutant emissions associated with the production and delivery of renewable diesel. However, the EU Commission study [65] reports that the WTT energy required to make HVO (renewable diesel) and biodiesel are very nearly the same. This suggests that the WTW criteria pollutant emissions from the *Vallejo* operating on renewable diesel would be similar to that reported in Table 10 and Figure 30 for the *Vallejo* operating on biodiesel. This finding is analogous to the similarity of renewable diesel and biodiesel in the WTW GHG emissions discussed previously in connection with Figure 29.

Table 10 and Figure 30 show that the SF-BREEZE operating on LH₂ derived from NG SMR reduces WTW NO_x by ~ 51.3% below that of the *Vallejo* operating on fossil diesel fuel (but held to Tier 4 emission standards). Using 70% Renewable LH₂ on the SF-BREEZE, the WTW NO_x is reduced 97.7% below the Tier 4 *Vallejo* levels. These reductions in NO_x can be traced to relatively less NO_x being produced when NG is burned for SMR process heat, and dramatically less NO_x associated with electrolysis of water using 70% renewable electricity.[69] WTW HC is reduced ~ 68.8% below that of the *Vallejo* operating on fossil diesel fuel (but held to Tier 4 emission standards) when the SF-BREEZE is operated on LH₂ derived from NG SMR. Using 70% Renewable LH₂, the WTW HC is reduced 82.1% below the Tier 4 *Vallejo* levels.

Figure 30 shows that the WTW PM emissions associated with the SF-BREEZE using 70% Renewable LH₂ are higher than that of the WTW PM emissions of the *Vallejo* running on fossil diesel. If the production

¹⁵ Refer to the last paragraph of Section 3.1.5.3 for a comparison of “biodiesel” and “renewable diesel”.

of LH₂ from water electrolysis were conducted using 84% renewable electricity or higher, the WTW PM emissions would fall below that for the *Vallejo* running on diesel fuel with Tier 4 compliance. Using 100% renewable electricity, the WTW criteria pollutant emissions for the SF-BREEZE would collapse to those for LH₂ trailer transport operating on diesel fuel, giving SF-BREEZE WTW NO_x, HC and PM emissions of 0.133 grams/passenger/trip, 0.0133 grams/passenger/trip and 0.00465 grams/passenger/trip, respectively. We have added these “100% renewable” SF-BREEZE emissions to Figure 30. Note that the TIAX report [69] did not report separate HC emissions for LH₂ trailer transport, so for discussion purposes we assume the HC emission to be 10% that of NO_x. Thus, using 100% renewable electricity, the SF-BREEZE WTW emissions would represent a 99.1% reduction in NO_x, a 99.2% reduction in HC and a 98.6% reduction in PM compared to the *Vallejo* running on diesel fuel with Tier 4 emission constraints. If the LH₂ trailer ran on 100% renewable hydrogen instead of diesel fuel, the criteria pollutant emissions could be essentially eliminated.

Summarizing these criteria pollutant emission results, the SF-BREEZE goes far beyond the Tier 4 criteria pollutant emissions requirements for new ferry construction in the U.S. because the powerplant is zero emissions at the point of use. Hydrogen PEM fuel cell technology can dramatically reduce WTW NO_x and HC emissions below the most advanced Tier 4 criteria pollutant emissions requirements regardless of whether the hydrogen is made by NG reforming or via water electrolysis using 70% or greater renewable energy. Renewable LH₂ made with greater than 84% renewable process energy is required to also drop the SF-BREEZE WTW PM emissions below that equivalent to Tier 4 requirements for high-speed fuel cell ferry transportation.

Our work takes place against the backdrop of prior measurements of maritime criteria pollutant emissions. These prior studies [70-73] report emissions per engine power or energy output, in units of g/MJ or g/kW-hr, respectively. For comparison to this prior work, we summarize in Table 11 the criteria pollutant (NO_x, HC and PM) and GHG (CO₂ (eq.)) emissions per trip for the SF-BREEZE running on LH₂ derived from fossil NG and renewable LH₂, as well as for the *Vallejo* running on fossil diesel fuel and biodiesel constrained to the Tier 4 criteria pollutant emission limits. This comparison does not normalize for the number of passengers being carried. Rather, it is a direct comparison of criteria and GHG emission on a “total engine energy” basis for these vessels performing one trip from Vallejo to San Francisco using the route profile of Figure 6. Recall that the total engine energy required (service energy + propulsion energy) of the SF-BREEZE to execute the Vallejo to San Francisco route is 1.125×10^{10} J (see Table 6) and that for the *Vallejo* running the same route is 8.78×10^9 J (see Table 7).

The results of the measurements of criteria pollutant emissions [70-73] from various vessels report NO_x emissions in the range 12 -15 g/kW-hr, HC in the range 0.027 – 0.208 g/kW-hr, and PM in the range 0.11 – 0.29 g/kW-hr. These emissions reflect engine pollution without selective catalytic reduction (SCR). Nuskowski and co-workers [73] conducted a study in which engine emissions were measured with and without SCR treatment. The study found that SCR reduced NO_x emissions from 15.35 g/kW-hr to 5.54 g/kW-hr. These post-treatment emissions are generally consistent with observations by Cooper [72] in which NO_x measurements for a marine diesel engine with SCR was observed to be 2.0 g/kW-hr. Since none of these marine engines were under Tier 4 constraints, their criteria pollutant emissions are larger

Table 11: Well-to-waves criteria pollutant and GHG emissions (in grams) reported per integrated engine output energy (in MJ and kW-hr) for the SF-BREEZE and the *Vallejo* for the Vallejo-San Francisco route described in Figure 5 and Figure 6 and in Table 1.

Per Trip Emission per Engine Power and Energy	SF-BREEZE Fossil NG LH ₂	SF-BREEZE Renewable LH ₂	<i>Vallejo</i> Fossil Diesel	<i>Vallejo</i> Biodiesel
NO_x (g/MJ)	0.0956	0.00450 ^a	0.503	0.511
NO_x (g/kW-hr)	0.344	0.0162 ^a	1.81	1.84
HC (g/MJ)	0.00743	0.00427 ^a	0.0614	0.0612
HC (g/kW-hr)	0.0267	0.0154 ^a	0.221	0.220
PM (g/MJ)	0.0106	0.00826 ^a	0.0113	0.0115
PM (g/kW-hr)	0.0382	0.0298 ^a	0.0407	0.0414
CO₂ (eq.) (g/MJ)	268.27	20.395 ^b	216.00	135.93
CO₂ (eq.) (g/kW-hr)	965.77	73.422 ^b	777.60	489.35

^aCriteria pollutant (NO_x, HC, PM) emissions per trip for SF-BREEZE fueled with Renewable LH₂ based on TIAx WTT input data [69] assuming 70% renewable energy used in the production of LH₂.

^bCO₂ (eq.) emissions per trip for SF-BREEZE fueled with Renewable LH₂ based on EU WTT input data [64, 65] assuming fully renewable energy used in the production of LH₂.

than those estimated for the SF-BREEZE using fossil NG LH₂ or renewable LH₂, as well as those estimated for the *Vallejo* using fossil diesel fuel or biodiesel under Tier 4 emission constraints. Note that the experiments measure emissions from the engine output only, and do not include fuel pathway criteria pollutant emissions, which we have seen are relatively small for the diesel and biodiesel fuels.

3.1.5.5 Summary

A theoretical comparison was made between the GHG emissions from the SF-BREEZE high-speed hydrogen PEM fuel cell ferry and the *Vallejo* Ferry, powered by traditional diesel engine technology. The emissions were calculated for a common maritime mission, the current ferry route between Vallejo CA and San Francisco CA. This route is challenging for the design of the fuel cell vessel because it is a long ferry route (24 nautical miles) and demands a high transit speed of 35 knots. Calculations were made of the fuel energy required for the SF-BREEZE and *Vallejo* to perform the mission route profile, taking into account the varying engine efficiencies in effect during different parts of the voyage. It was found that the SF-BREEZE requires 10.1% more fuel energy (LHV) than the *Vallejo*, primarily due to the SF-BREEZE being heavier. Since the PEM fuel cell is a zero-emissions power plant, the WTW GHG emissions for the Vallejo to San Francisco route are determined entirely by the WTT GHG emissions associated with hydrogen production. In contrast, for the *Vallejo*, if fossil-based diesel fuel is used, the vessel WTW GHG emissions are determined by the sum of the GHG emissions associated with diesel fuel production and delivery plus the carbon released in diesel combustion onboard the vessel.

A description was given of the 2007/2013 European Commission study of WTT pathways and GHG emissions associated with hydrogen, diesel and biodiesel fuel production. Using this prior work, estimates were made for the WTT SF-BREEZE GHG emissions associated with five LH₂ production pathways. The LH₂ production pathways are: 1) steam methane reforming of fossil-based NG; 2)

electrolysis of water using grid power; 3) hydrogen production from wood gasification; 4) electrolysis of water from wind-based electricity and 5) electrolysis of water from nuclear-based electricity. Pathways 3 – 5 are considered renewable LH₂ production methods. We also examined the *Vallejo* WTW GHG emissions associated with fossil-diesel use, as well as with biodiesel, which can be considered a renewable fuel replacement for conventional diesel fuel.

Using this input data, we predict that the WTW GHG emissions from the SF-BREEZE using LH₂ derived from reforming NG is 20.12 kg CO₂ (eq.)/passenger/trip for the Vallejo to San Francisco Ferry route. Using renewable LH₂, the WTW GHG emissions for the SF-BREEZE drop dramatically to 1.53 kg CO₂ (eq.)/passenger/trip. For the *Vallejo*, we find that the WTW GHG emissions using fossil diesel fuel are 6.32 kg CO₂ (eq.)/passenger/trip. Using biodiesel, we estimate the WTW GHG emissions from the *Vallejo* are 3.98 kg CO₂ (eq.)/passenger/trip. The GHG results show that hydrogen PEM fuel cell technology can dramatically reduce the GHG emissions from high-speed ferry operations. However, nearly 100% renewable hydrogen must be used to achieve the desired deep cuts (76%) in GHG emissions that are commensurate with the challenge presented by global climate change.

We also compared the criteria (NO_x, HC, PM) pollutant emissions for the SF-BREEZE to that of the *Vallejo* held to Tier 4 emissions standards fueled by diesel fuel or biodiesel. While the hydrogen PEM fuel cell technology goes far beyond the Tier 4 criteria emission requirements because it is zero-emission technology at the point of use, it is important to consider the fuel production pathway and delivery emissions in a well to waves (WTW) analysis. Using WTT estimates for criteria pollutant emissions from a study by TIAx associated with the production of LH₂ (by both renewable and non-renewable means) diesel and biodiesel, we compared the WTW criteria pollutant (NO_x, HC, PM) emissions for the SF-BREEZE to that of the *Vallejo* held to Tier 4 emissions standards fueled by diesel fuel or biodiesel. Compared to *Vallejo* Tier 4 emissions using diesel fuel, the SF-BREEZE using LH₂ derived from steam reforming of fossil natural gas reduces NO_x by 51.3%, HC by 68.8%, but PM emissions increase a factor of 2.5 times. Using 70% renewable LH₂, the SF-BREEZE reduces NO_x by 97.7%, HC by 82.1%, but PM still is elevated, by a factor of 1.9. Thus, even when considering the hydrogen production and delivery pathway, hydrogen PEM fuel cell technology dramatically reduces WTW NO_x and HC emissions below the most advanced Tier 4 criteria pollutant emissions requirements regardless of whether the LH₂ is made by NG reforming or via water electrolysis using 70% renewable energy. Renewable LH₂ made with greater than 84% renewable process energy is required to also dramatically drop the SF-BREEZE WTW PM emissions below that of the equivalent Tier 4 for high-speed fuel cell ferry transportation. Using 100% renewable electricity, there would be a 99.1% reduction in NO_x, a 99.2% reduction in HC and a 98.6% reduction in PM compared to the *Vallejo* running on diesel fuel with Tier 4 emission constraints.

Overall, the results show that operating a hydrogen fuel cell ferry on nearly 100% renewable hydrogen provides the dramatic reduction in vessel GHG and criteria pollutant emissions commensurate with the problems of global climate change and increasing maritime air pollution worldwide.

3.2 Regulatory Assessment

As a novel vessel, there is no existing regulation that completely covers the design and operation of the SF-BREEZE. This is primarily due to the presence of hydrogen, and to a lesser extent, that of the fuel

cells. The base regulation for the vessel is 46 CFR Subchapter T – Small Passenger Vessels (or just, “Subchapter T”) but it does not have any scope covering hydrogen as a fuel. To cover this gap, the project team relied heavily on other codes and regulations. For example, the Regulatory Gap Analysis prepared by EBDG as part of their Design Study Report summarizes 68 different aspects of vessel design and finds that just 11 are covered by Subchapter T.

One of the primary documents used to fill in the gap with respect to on-board hydrogen as a fuel is the 2015 International Code of Safety for Ships using Gases or other Low-flashpoint Fuels (IMO MSC 95/22/Add.1) or simply, the “IGF Code”. While its title is inclusive of hydrogen (a “low flashpoint fuel”), by its own admission the current version is written to be applicable for natural gas. Furthermore, the code is written for vessels that fall into the SOLAS (Safety of Life at Sea) category, that is, large international, ocean going vessels. By contrast, the SF-BREEZE is a small passenger vessel to be operated in the inland waters of the San Francisco Bay. Therefore, some of the requirements in the IGF Code are not appropriate for the SF-BREEZE – many are too conservative.

The proposed design is therefore in conflict with some recommended regulations and codes. The project team is well aware of the precedent that can be set by approval of a vessel that is the first of its kind, as the SF-BREEZE is in the United States. For this reason the design was based on technical judgment considering the unique properties of hydrogen. The goal is to ensure that regulations imposed on the SF-BREEZE and future hydrogen-powered vessels are based on sound science resulting in an acceptable balance between safety and practical implementation. This approach was supported by the U.S. Coast Guard.

The regulatory aspects of the vessel design are largely described in EBDG’s Design Study Report. Regulations also require a detailed Risk Assessment for any novel features. For the SF-BREEZE, EBDG prepared a preliminary Risk Assessment, also included in Appendix A.

The design package was evaluated by both the USCG and ABS for regulatory acceptance. This section includes additional detail and discussion on certain aspects of the design and risk assessment, especially those areas identified by EBDG as in conflict with existing regulation, and by USCG and ABS as caveats in their acceptance of the design. ABS’ conditional Approval In Principle (AIP) of the design can be found in Appendix B. While the USCG has declined to formally review the design, this section includes discussion of specific issues raised and anticipated design requirements based on the regular discussions with USCG staff throughout the project.

3.2.1 Relevant Standards (Design Basis)

The base regulation governing the vessel design is 46 CFR Subchapter T – Small Passenger Vessels. The following regulations, rules, guidance, and standards were also used when needed:

- 46 CFR Subchapter J – Electrical Engineering
- 46 CFR Subchapter F – Marine Engineering
- 2015 International Code of Safety for Ships using Gases or other Low-flashpoint Fuels (IMO MSC 95/22/Add.1 (Adopted IGF Code))
- IMO CCC 2/3/1 (IGF Code with Fuel Cell Additions)

- 2016 ABS Rules for Building and Classing Steel Vessels (SVR)
- 2016 ABS Rules for High Speed Craft
- 2016 ABS Guide for Propulsion and Auxiliary Systems for Gas Fueled ships
- ASME B31.12 Hydrogen Piping and Pipelines
- ANSI/CSA America FC1-2004 Stationary Fuel Cell Power Systems
- IEC 60092-502 Electrical Installations on Ships
- IEC 60079-10 Electrical Apparatus for Explosive Gas Atmospheres
- IEC 62282-2 Fuel Cell Technologies - Part 2: Fuel Cell Modules
- IEC 62282-3 Fuel Cell Technologies - Part 3-100: Stationary Fuel Cell Power Systems - Safety
- IEC 60068-2-6 Environmental Testing – Part 2-6: Tests – Test Fc: Vibration (Sinusoidal)

3.2.2 Fire Protection

Fire protection refers to the on-board systems that protect the vessel, crew, and passengers in case of an on-board fire. For the SF-BREEZE, typical fire protection systems were specified for the non-novel part of the ferry. However, the areas on the top deck around the LH₂ tank, and on the main deck in the fuel cell rooms were examined in more detail. Through collaborative discussions with fire protection experts at USCG and Sandia (which has a decades-long experience in the safe use of hydrogen) along with the rest of the project team, the following strategies were adopted by the present design.

3.2.2.1 Fire on Upper Deck

A fire on the upper deck could be from a hydrogen leak or from a non-hydrogen source. In either case the recommendation is to shut off the hydrogen source and use aqueous film forming foam (AFFF) to fight the fire and keep the surfaces cool.

AFFF is deployed as a concentrate that is mixed into the water going to the spray nozzles. Its density and viscosity can be tailored for the best effectiveness given the environmental conditions. It sticks to surfaces and will not get blown away by the wind. AFFF is 94% water so its primary function cooling (like water), but AFFF also fights the fire.

A spray-down of AFFF would typically last for 30-40 minutes, after which plain water will continue to flow out of the nozzles until the system is deactivated. This would likely be a manual system because on the open deck it would be hard to remotely detect gas buildup, heat, or smoke as they would dissipate quickly if the vessel were at 35 knots.

AFFF is common on Liquid Gas Carriers (LGCs). Although the IGF Code requirements are specific to water, the USCG acknowledges that AFFF may be an acceptable substitute on vessels which use hydrogen as a fuel.

3.2.2.2 Fire in the Fuel Cell Room

Similar to the upper deck, a fire in the fuel cell room could result from a hydrogen leak or non-hydrogen source (such as an electrical fire). From a technical standpoint the following fire protection method was determined to be the most appropriate:

1. Shut the hydrogen source using at least two redundant methods

2. If there is hydrogen in the room, ventilate using existing ventilation installed on the SF-BREEZE
3. If there is fire/smoke in the room, close ventilation and use a gaseous fire suppressant system
4. Water can be used as a backup to gas suppression

As it turns out, this is the same strategy called for in the IGF Code for a machinery space and is consistent with the requirements of Subchapter T. It was determined that this would therefore be an acceptable regulatory approach.

Some of the details of the fuel cell room fire protection system remain to be designed. In particular, automation and sequencing, returning to normal atmosphere without flashback, and type of gas suppressant. On the latter, discussion focused around the trade-offs between using FM200 and CO₂ (FM200 is the Dupont tradename for heptafluoropropane). FM200 will disperse cleanly once deployed and leave no residue on equipment, and it is non-toxic. FM200 is a more effective suppressant than CO₂ because it interrupts the chemical reaction of combustion while CO₂ simply displaces oxygen to smother the fire by lack of oxidant. Because of this difference FM200 can work at concentrations as low as 7% (typical, but depends on room size and other factors). This means that the room where it is deployed does not need to remain completely gas tight. (For example, Sandia uses FM200 in computer server rooms where ventilation is constantly 6 air changes per hour (ACH). However, the normal ventilation air flow through the fuel cell room is planned to be 30 ACH; hence the rationale for shutting down the ventilation system in case of fire.)

3.2.2.3 Fire Barrier Insulation

EBDG's Design Study Report notes that the current design does not comply with IGF Code in terms of fire protection insulation on the upper deck of the vessel. The IGF Code requires A60-class insulation, while Sandia analysis of the properties of hydrogen dispersion, LH₂ spills, and resulting fires shows that fires of even very large amounts of hydrogen are completed in a very short time – much shorter than a pool fire of conventional liquid fuels (Section 3.2.6.7). The design team therefore proposed to USCG and ABS the removal of the A60 insulation requirement on the top deck in effort to minimize the weight of the vessel.

ABS' AIP notes that the current level of detail is not sufficient to evaluate the acceptance of the proposed design. It recommends a developed HAZID/HAZOP in the detailed design submittal after which time the proposal will be evaluated.

USCG likewise needs additional information (unspecified to-date) prior to full evaluation of this concept.

The vessel will be feasible whether or not ABS and USCG accept the elimination of the A60 barrier. Requiring the A60 barrier will affect only the weight of the vessel and resulting cost, see Section 3.1.4.4, and can always be installed if required by regulation.

3.2.3 Hazardous Zones

Hazardous zones are identified in order to determine required precautions in the design, such as installation of rated electrical equipment and placement of ventilation systems and passenger accommodation spaces. EBDG identifies hazardous zones in accordance with the IGF Code in the EBDG

Design Study Report. In this process, two areas of exception were identified between the design of the ferry and the IGF Code requirement. The EBDG DSR describes the issue and proposed solution; here we discuss the acceptability of each of these proposed designs.

3.2.3.1 IGF Code Paragraph 6.7.2.8 (Pressure Relief Valve Outlets)

As designed, the air inlets for the fuel cell rooms are within 10 m of the LH₂ storage tank's pressure relief valve outlets, the minimum distance specified in the IGF Code. Considering the high buoyancy of hydrogen (Section 3.2.6), existing land-based codes for hydrogen systems (NFPA 2 and by reference CGA 5-5) use a 10 ft minimum distance. ABS requires a more detailed risk assessment and HAZID/HAZOP study to complete its evaluation of this conflict. The USCG will likely require a gas dispersion analysis for its evaluation. If the design is rejected, re-routing the relief valve outlet will be required and may result in a taller vent mast, but would not have an effect on vessel feasibility.

3.2.3.2 IGF Code Paragraph 13.3.5 (Air Inlets)

Two instances of air inlets do not meet the minimum distance requirements of the IGF Code: the lazarette and steering gear rooms relative to the fuel cell room, and the fuel cell room relative to the downward spillage coaming around the vaporizers on the top deck. In both cases the high buoyancy of hydrogen (Section 3.2.6) makes it extremely unlikely that hydrogen will flow downward and enter the inlet in question.

In the first case, additional consideration is that the fuel cell room is not considered hazardous in normal operation, only if a hydrogen leak is detected. ABS has indicated their acceptance of the design as proposed. USCG also felt this was reasonable based on alignment with the IGF Code's "ESD protected machinery space concept" for natural gas fueled vessels.

In the second case, ABS requires a more detailed risk assessment and HAZID/HAZOP study to complete its evaluation of this conflict. USCG may require a gas dispersion analysis prior to making their determination. EBDG is confident of being able to find an engineering or design solution if the design is not accepted as proposed.

3.2.4 LH₂ Tank and Vaporizers

The current design of the LH₂ tank and vaporizer system has a single tank and two vaporizers and is in compliance with the IGF Code. Typically the IGF Code requires redundant fuel supply including tanks, although there is an allowance for a single tank if the tank is "Type C" (a pressure vessel). The SF-BREEZE utilizes a Type C tank so it falls into this category.

The IGF Code also has redundancy requirements for piping and vaporizers between the tank and the engine room (fuel cell room). To save weight and space, it would be preferred to have a single vaporizer. While the equipment is robust, there is a concern around a gas detection event shutting down the vaporizer or isolating the piping, causing a total loss of power on the vessel. For the design of the SF-BREEZE it was conservatively decided to plan on having dual redundant vaporizers and dual, cross-connected piping to meet what seems to be the intent of the IGF Code (see Figure 31). However, for a boat operating in inland waters, failure of the propulsion system is tolerated by regulation (Subchapter T does not include any such redundancy requirement). The SF-BREEZE also includes a

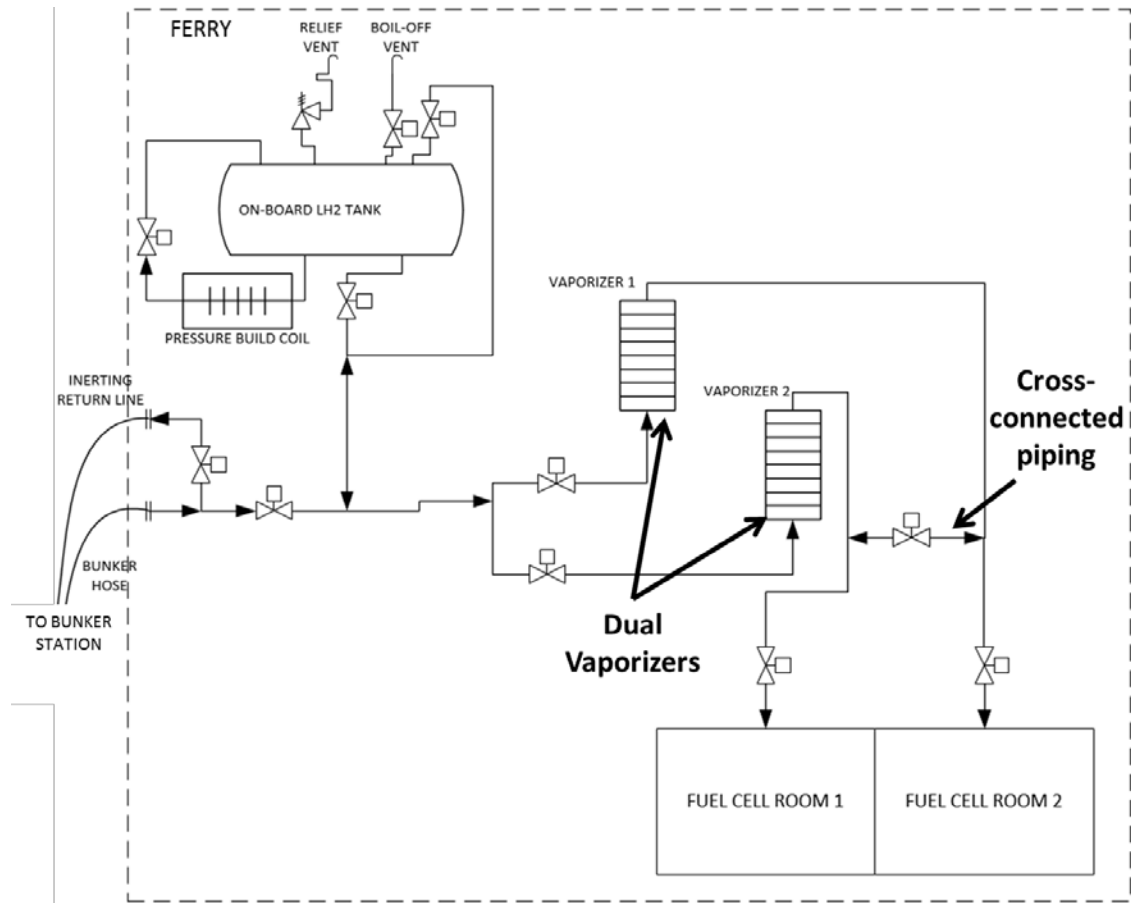

Figure 31: Schematic of the fuel system on-board the SF-BREEZE highlighting the location of the redundant vaporizers and cross-connected supply piping. For the accompanying bunkering station schematic see Figure 43.

battery system that can be used to power communications and navigation equipment for 1-2 hours. Considering the actual risk to passengers of a power failure in the San Francisco Bay, it may be possible for the vessel to include only a single vaporizer and be equivalent with Subchapter T requirements. This would reduce the design weight by close to 2,000 lb.

One additional factor in this consideration was raised by USCG Sector San Francisco. While operation in the San Francisco Bay with its wide availability of support vessels and short distance to shore in all areas offers advantages in case of power failure, the Bay is also trafficked by large ships calling on the various ports. A power failure in a shipping lane could be a serious hazard. Based on this input, it may be that the best solution for the particular case of the SF-BREEZE be including a single full-size evaporator and a smaller redundant evaporator that is sized for hydrogen flow necessary to restore maneuvering power (but not operate at full speed).

The number and size of the vaporizers does not affect vessel feasibility. However, reduction in the number or size of the vaporizers would reduce vessel weight and cost.

3.2.5 Vessel Operation

The project team met with USCG Sector San Francisco on three different occasions to discuss the project and to understand any potential operational or local issues that may affect feasibility. In general the Sector was extremely supportive and offered the following observations:

- There needs to be a plan for the on-board LH₂ if the vessel needs to be in dry dock for maintenance.
- The fueling station may need to be manned for security.
- While design regulations may not require redundant propulsion power, the Sector believes the vessel should have enough backup power to get out of the shipping channels in the Bay.
- Suggest that the bunkering system be tested with LN₂ before LH₂ is used.

All of these suggestions are implementable with no effect on feasibility.

3.2.6 LH₂ as a Vessel Fuel (With Comparison to LNG)

As noted in the preceding sections, regulations governing the use of LH₂ as a fuel on board vessels are in the developmental stages. While not excluding LH₂, it is clear that the current focus of the “low flashpoint fuels” regulations is on LNG. Part of this is the large commercial movement towards LNG as a fuel. However, another aspect is the lack of familiarity with LH₂.

This section discusses LH₂ as a vessel fuel, from description of its fundamental properties to its practical application and safety aspects, with the SF-BREEZE as a case study. Since maritime regulations have been formulated to cover LNG use as a primary propulsion fuel, it was natural that our examination of the safe use of LH₂ as a primary fuel for ferries be couched as a comparison to LNG, for both the maritime environment generally, and specifically for the SF-BREEZE. This comparison required pulling information from many sources in order to form a complete picture of the differences between LH₂ and LNG as practical maritime fuels. This section reviews both the physical and chemical nature of these fuels that impact safety, as well as the very different character of the fires derived from burning LH₂ and LNG. We supplement this existing information with new analyses that shed additional light on the uses of LH₂ and LNG in marine applications.

3.2.6.1 Background

It is timely to compare and contrast the physical and combustion properties of LH₂ and LNG. In 1978, Hord provided [74] an excellent and comprehensive comparison of the safety properties of hydrogen and methane (the primary constituent of NG), with both fuels being compared to gasoline. In 1981, Donakowski [75] assessed LH₂ and LNG physical and combustion properties with regard to safety. Also in the early 1980's NASA sponsored separate work by Lockheed and the Arthur D. Little Company to investigate hydrogen-fueled commercial aircraft. Both studies involved technical and safety comparisons between LH₂, LNG and conventional jet fuel (Jet-A) in their use as primary aviation fuels. Brewer has published the results of the Lockheed work in both journal [76] and book [77] form. The results of the A.D. Little study were summarized in several NASA reports in 1960, 1964 and 1982 [78-80]. The comparative properties of LH₂ and liquid methane (LCH₄) for aviation were later reviewed by Contreras and co-workers in 1997 [81], who also reviewed some subsequent designs for LH₂ aircraft conceived by

the Airbus consortium and Boeing. In many ways, hydrogen use in aircraft is similar to its use in high-speed ferries, as both aircraft and high-speed watercraft are very weight-sensitive applications, favoring storing hydrogen on-board as a liquid. Safety comparisons between compressed natural gas and compressed hydrogen as automotive fuels were reported by Karim in 1983 [82].

Since these prior comparisons, there has been significant progress in elucidating the combustion properties of hydrogen, particularly with regard to the effects of buoyancy and turbulent mixing on combustion and the “deflagration to detonation transition” (DDT). Advanced modeling studies have clarified how cryogenic fuels spread and vaporize when spilled on the ground or other surfaces. In addition, there have been a couple of decades of further experience handling LH₂ and LNG, and development of associated codes and standards. Here we provide an updated review with these new developments, with a focus appropriate for the comparison of LH₂ and LNG in maritime applications.

3.2.6.2 Physical Properties

Unlike hydrogen derived from LH₂, LNG is a mixture with composition that varies depending on place of origin. LNG is typically ~ 93% methane, ~ 5% ethane, with the balance being propane, butane, nitrogen and other trace gases. The percentage of methane runs from 87% to 96% depending on source (see, for example, Ref. [83]). While in some cases the approximation is made that the physical and combustion properties of LNG can be fairly represented by those of LCH₄, it is worth noting that the composition variations do have observable effects (typically modest) on the combustion properties [84] and the net GHG emissions associated with LNG combustion [83]. The fact that LNG consists of a mixture introduces the phenomenon of compositional “stratification” whereby density and temperature differences arising from the mixture can lead to increased local vaporization (called rollover) [85]. Because of its purity, LH₂ in the tank is not susceptible to rollover.

Hydrogen is the lightest gas, with a density of 0.08376 kg/m³ at normal temperature and pressure (NTP), 293.15K, 1 atmosphere pressure. Methane is considerably heavier, with a density at NTP of 0.65119 kg/m³. Both gases are more buoyant than air, which has a NTP density of 1.204 kg/m³. It is generally not possible to accurately specify the “rising velocity” of a practical hydrogen or methane release, because the terminal rising velocity is established as a balance of the buoyant force (pointed up), gravitational force (pointed down), and the atmospheric drag (pointed down) on the gas volume as it rises. The atmospheric drag depends on the shape and cross-sectional area of the released gas volume, which in practical releases is unknown and can depend on the initial conditions of the release, turbulence and wind conditions. Furthermore, the density of air depends on relative humidity. To give a sense of the relative rising rates for hydrogen and methane at NTP for spherical volumes of released gas in the absence of wind or turbulence, we show in Figure 32 a plot of the terminal rising velocity in air (under these assumptions) for both gases. For the hydrogen fuel complement of the SF-BREEZE (1200 kg), this mass of hydrogen would, at NTP, occupy a sphere with radius 15.07 m, with a terminal rising velocity of 27.92 m/s (62 mph). The same mass of methane would occupy a sphere of radius 7.61 m with terminal rising velocity of 13.93 m/s (31 mph). Clearly, hydrogen is significantly more buoyant than methane, although both rise quickly in air at NTP.

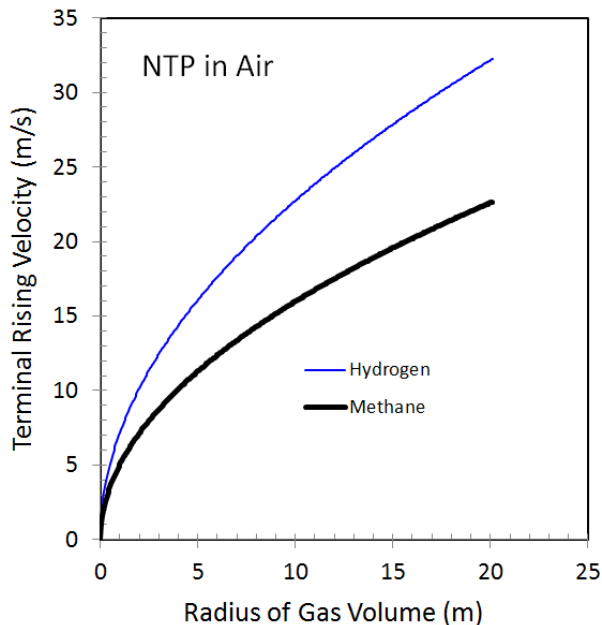

Figure 32: The terminal rising velocity for spherical volumes of hydrogen and methane in air at NTP (293.15 K, 1 atmosphere pressure). The figure assumes NTP gas densities of 1.204 kg/m³ for air, 0.08376 kg/m³ for hydrogen and 0.65119 kg/m³ for methane.

Being a homolytic diatomic molecule, hydrogen has no dipole moment, and vibrations of the molecule cannot produce charge separation along the bond axis. This means that hydrogen does not interact with infrared radiation, and is not a greenhouse gas. In contrast, since methane is a heterolytic molecule with different elements bonded together, the bonds are inherently polar, and stretches and bends of C-H bonds produce charge fluctuations that can couple to infrared electromagnetic radiation. This character makes methane a potent greenhouse gas, ~ 23 times more capable of trapping heat in the atmosphere than CO₂. This fundamental difference between hydrogen and methane makes methane leaks from LNG infrastructure a serious environmental concern and an economic loss, whereas leaks from a hydrogen infrastructure would have only an economic impact.

A defining characteristic of molecular hydrogen is the very weak attractive van der Waals interactions between H₂ molecules. The intermolecular attractions between H₂ molecules are weaker than those between CH₄ molecules, which explains the lower boiling temperature for LH₂ compared to LCH₄ (LNG). The normal boiling point for hydrogen is 20 K; the normal boiling point for LCH₄ is 111 K. An important consequence for the difference in boiling points is that liquid methane (at its boiling point) cannot liquefy air, whereas LH₂ can liquefy air, whose main components N₂ and O₂ condense at 77.3 K and 90.2 K, respectively. These atmospheric gases can also solidify when exposed to LH₂, as the melting points for solid N₂ and solid O₂ are 63.3 K and 54.8 K, respectively. The potential for liquefying or solidifying air introduces safety concerns arising from clogging hydrogen lines with condensed air, as well as concerns about reactivity stemming from condensed oxygen. As a practical matter, these air condensation issues are routinely handled in LH₂ fueling operations by purging the LH₂ plumbing lines with hydrogen or helium (more typically hydrogen due to its availability and lower cost).

The weak intermolecular attraction for hydrogen, combined with hydrogen's low mass, makes LH₂ a low-density fluid. The density of LH₂ is 71 g/L at its normal boiling point of 20 K and 1 atm. The density of LCH₄ at its normal boiling point of 111 K is 422 g/L at 1 atm. For comparison, the density of liquid water at NTP is 1000 g/L. Because the gravimetric energy density of hydrogen is more than twice that of methane (120 kJ/kg for hydrogen vs 50 kJ/kg for methane), for the same amount of stored energy, LH₂ has 0.38 times the mass of LCH₄, but has 2.4 times the volume.

Both hydrogen and methane are less dense than air at room temperature and pressure. An important safety-related question is: when these liquids evaporate, producing either cold hydrogen gas at 20 K, or cold methane gas at 111 K, how much do these gases have to warm before they become more buoyant than ambient air? If we assume that for small leaks, the ambient air is not cooled too much and remains near NTP, then the cold gaseous hydrogen will become more buoyant than NTP air (with density 1.204 kg/m³) at 22.07 K [86]. In other words, cold hydrogen gas formed from a release of LH₂ needs only to warm up by ~ 2 K in order to become more buoyant than air at NTP conditions. In contrast, methane needs to warm up 53.3 K, from 111 K to 164.3 K, before its gas-phase density equals that of NTP air [86]. As a result, when LCH₄ evaporates at 111 K, the cold methane gas stays non-buoyant for significantly longer times than does LH₂.

The weak intermolecular attractions between hydrogen molecules leads to the enthalpy of vaporization ΔH_{vap} of LH₂ being only 0.92 kJ/mole, 9.2 times less than that of LCH₄, whose ΔH_{vap} value is 8.5 kJ/mole [58]. For comparison, the ΔH_{vap} of liquid water is 40.66 kJ/mole, due to the strong hydrogen bonding found between water molecules. For equal amounts of stored energy, LH₂ takes 3 times less thermal energy to evaporate than LCH₄.

3.2.6.2.1 Permeation

Hydrogen permeation arises from the dissociation of molecular hydrogen at metal and oxide surfaces into hydrogen atoms, and the subsequent diffusion of hydrogen atoms through materials involved in hydrogen storage and plumbing lines. Hydrogen atoms produced in this way can also lead to hydrogen embrittlement, which is a very important phenomenon in materials science. Many misinterpret hydrogen permeation (even in the absence of embrittlement) as a leak risk. The concern is that hydrogen diffusing through tubing and other fittings can pass through the material and exit as hydrogen gas.

Permeation as a source of leaking is not an issue for the practical performance of tubing, valves or other hardware because the quantities of gas exiting in this way are infinitesimal. San Marchi and co-workers have described hydrogen permeation in stainless steels at high pressure [51], reviewing the fundamental thermodynamics and kinetics of hydrogen permeation, diffusion and solubility in a material supporting a pressure differential. Hydrogen permeation is defined as the product $D \cdot K$, where D is the diffusivity and K is the equilibrium constant for hydrogen dissolving from the gas phase into a material. We now assess hydrogen dissolution, permeation and diffusion in metals as a leak risk using experimentally determined values for solubility and diffusion in steel alloys [51].

We ask the question: “If the entire 1200 kg fuel complement of the SF-BREEZE LH₂ tank were vaporized to room temperature, and compressed to 150 psi (the maximal pressure to be found anywhere on the SF-BREEZE), what would the rate of hydrogen diffusion be through 1/16” thick 300 series (304, 316) stainless steel?” This corresponds to the maximal hydrogen permeation conditions (highest temperature, highest pressure, smallest hardware wall thickness) that could exist in the SF-BREEZE hydrogen-fueling manifold. Note that the solubility, permeation and diffusion of hydrogen in 304 and 316 alloys are the same to within experimental accuracy [51]. If one takes the entire 1200 kg of hydrogen, vaporizes it to room temperature, and enclosed it in a spherical 316 container and compressed the gas to 150 psi, the sphere would have a radius of 7.0 m. Assuming a 1/16” wall thickness for the sphere, we can calculate the rate of passage of hydrogen from the interior of the sphere to the exterior, exiting the sphere as hydrogen gas “leaking” across its entire external surface area. Under these circumstances, the flux of hydrogen out of the sphere in steady state would be 1.56×10^{-9} moles/s. Hydrogen diffusion is a thermally activated process, and drops off drastically as the temperature is lowered. At 200 K, the rate of flux would be 1.13×10^{-14} moles/s, which shows how dramatically this thermally activate process is reduced for even mildly cryogenic conditions.

This leakage rate of 1.56×10^{-9} moles/s needs context. If one were to fill a classic model KS-21716 AT&T telephone booth (dimensions H x W x D = 211 cm x 85 cm x 85 cm) with this permeation leakage of hydrogen, it would take 60 years to reach the 4% LFL. One might ask how much hydrogen the 150 passengers on the SF-BREEZE are releasing. Hydrogen is a well-known product of human metabolism, produced at ~ 3 ppm levels in human respiration. Assuming an average human lung tidal volume of 0.5 liters/breath, and a respiration rate of 20 breaths /minute, one can readily calculate that it would take 10.3 days for the hydrogen from passenger respiration, directed into the KS-21716 phone booth, to reach the 4% LFL. This assumes of course that only hydrogen from the respiration enters the phone booth. The point of this discussion is that permeation in the context of the SF-BREEZE is not an issue for leakage from plumbing systems such as valves, fittings, tubes, etc. because it is infinitesimal. Passenger breathing represents a vastly larger source of hydrogen. It is also worth noting that welds do not affect the rate of diffusion in metal samples, and in fact, microscopic defects in welds can actually act as hydrogen traps, slowing diffusion. Hydrogen solution, permeation and diffusion, even though involving vanishingly small quantities of hydrogen from a leak perspective, are key ingredients to the phenomenon of hydrogen embrittlement.

One might reasonably ask if CH₄ containment can lead to molecular dissociation, releasing hydrogen atoms into a vessel wall material where it can then diffuse, resulting in permeation and perhaps even hydrogen embrittlement. The surface science of methane adsorbed on Fe is very different from hydrogen adsorbed on Fe. In investigations both experimental [87] and theoretical [88], methane bonds to Fe films in a very weakly bound “physisorbed” state, characterized by thermal desorption from the surface at 130 K. Methane does not adsorb to iron surfaces at room temperature. Even for temperatures below 130 K in which methane is bound to Fe, there is no dissociation into hydrogen and carbon, because the energy barrier for breaking the C-H bonds is unfavorable [89]. In contrast, hydrogen is dissociated at Fe surfaces as revealed in theoretical [89] and experimental [90] studies, forming bound chemisorbed H atoms that are stable at room temperature and desorb only if the

temperature is raised to greater than ~ 625 K. This basic surface science explains why methane does not dissociate at stainless steel surfaces (with majority component Fe), and as a result is not a source of hydrogen atom production at internal natural gas plumbing or storage surfaces.

3.2.6.2.2 Embrittlement

Hydrogen embrittlement is a significant area of materials science, and it is beyond the scope of this report to cover it in a comprehensive manner. Excellent reviews exist [91, 92]. As described above, hydrogen embrittlement does not exist for materials carrying LNG, NG or methane because there is no methane dissociation at the metallic surface. On the other hand, hydrogen atoms produced by the dissociation of H_2 at metallic surfaces can diffuse into the bulk of the material, and accumulate at defect sites in the presence of material strain (which all practical materials have to some extent). Because of the combination of hydrogen, pre-existing defects and strain, hydrogen atoms can accumulate at defect sites, and form brittle metal hydrides such as FeH_2 and CoH_2 . If the pre-existing defect is a small crack, the hydriding of the surrounding metal can lead to facile crack growth and eventual material failure. This is a problem for ferritic (bcc) steels, but not for austenitic (fcc) steels, or copper or aluminum, as described in prior reviews [91, 92].

As a practical matter, hydrogen embrittlement is circumvented in hydrogen technology by using 304 or 316 stainless steels, aluminum, or copper in hydrogen storage systems and piping. Decades of industrial experience show these materials are robust to hydrogen embrittlement. This materials choice is similar in spirit to choosing copper over iron in the manufacture of electrical wiring. (Copper has a higher electrical and thermal conductivity than Fe, and using copper reduces resistive losses and promotes thermal management.) Similarly, the correct materials must be chosen for hydrogen service. The practical experience of the gas providers is that hydrogen embrittlement is not a maintenance issue for LH_2 or other hydrogen plumbing (tubing, piping) when type 304 or 316 stainless steel materials are properly used [61]. Like most commercial LH_2 tanks, the interior liner of the LH_2 tank of the SF-BREEZE will be 304 stainless steel. One could contemplate using lighter weight aluminum for the inner liner, but it is structurally weaker and requires using thicker liners (which mostly defeats the lighter weight advantage), and has an undesirable larger thermal conductivity, which increases heat leak.

3.2.6.3 Spills

The A.D. Little Company [80] performed an early comparison of LH_2 and LNG (LCH_4) in the context of cryogenically fueled commercial aircraft. This work concentrated on the combined problem of fluid flow when in contact with the ground along with ignition. Witcofski and Chirivella at NASA Langley [93] conducted the first large scale spill tests of LH_2 in the absence of ignition, with a focus on the measured hydrogen content of vapor clouds at varying distances from the pool spill. This NASA work motivated subsequent work on predicting the duration and physical extent of LH_2 spills, as well as those of other cryogens including LCH_4 . Verfonden and Dienhart performed pioneering model studies of the NASA experiments and conducted controlled spill tests focusing on the extent and duration of LH_2 spilled onto water and aluminum [94, 95], two surfaces very relevant for the SF-BREEZE application. These workers also developed a mathematical model called LAuV to address the relevant phenomena involved in cryogenic pool spreading and vaporization. The LAuV model predictions for pool radius and duration received prior validation by comparison with LNG pool spreading experiments.

The NASA spill tests did not emphasize the size and duration of the LH₂ pool, but one spill trial did provide data that a spill of 5.7 m³ (404.7 kg) of LH₂ produced a maximal radius of 2 - 3 meters and the entire pool evaporated within 5 seconds after cessation of active spilling (with occurred after 38 seconds). Verfonden and Dienhart's model of this spill test predicted a LH₂ radius of 6.5 m, and excellent agreement with the duration data [94, 95]. These foundational studies point to LH₂ spills having very short durations and relatively small physical extents, both due to the high vaporization rate produced by the low ΔH_{vap} value. Heat conduction from the ground is the dominant contributor to evaporation of spilled pools of cryogenic liquids [94, 95].

The LAuV model gave an excellent account of the controlled LH₂ spill tests on both the surface of the water and on aluminum [94, 95]. Experimentally, the duration of the pool was determined mostly by the practical speed at which LH₂ could be physically spilled, which was 62 seconds in these tests. For example, for 0.31 m³ (22.0 kg) of LH₂ spilled on water, the observed and calculated pool radii were both ~ 0.6 m, and the model predicts the pool completely evaporates at 62.9 seconds, within 1 second of completion of fuel spill. Spills onto water had a larger radius (0.6 m vs. 0.4 m) than those on aluminum due to ice formation and the subsequent poorer heat transfer to the LH₂ pool. Overall, spill results on water or solid surfaces were comparable in size and duration.

The LAuV model was also used to predict the pool radii and vaporization times (duration) for 40 m³ instantaneous spills of the LH₂ and LNG (modeled as 87% methane and 13% propane) on solid ground. Table 12 summarizes these results [95].

It is clear from Table 12 that due to the exceptionally low ΔH_{vap} value, LH₂ spills are very short duration events. Using the duration and size predictions in Table 12 for 2,840 kg of LH₂ as a basis for linear interpolation to 1200 kg, we estimate for the SF-BREEZE that if the entire 1200 kg contents of the LH₂ tank instantaneously spilled onto the top deck, the cryogenic pool would last ~ 6 seconds and spread to a maximal radius of ~ 8 meters.

The extraordinarily low ΔH_{vap} value for hydrogen has another important consequence for its use as a maritime fuel: because it takes less energy to evaporate it, LH₂ will cool surrounding surfaces much less than an LCH₄ (LNG) spill. This is an important consideration for structural elements of a ferry, as mild ferritic steels can undergo brittle fracture when exposed to cryogenic temperatures [96]. The SF-BREEZE structure is made of aluminum, which does not suffer brittle fracture even when cooled to very cold temperatures [97].

Using the information described in the above-mentioned studies, we have analyzed the effect of spilling the entire 1200 kg LH₂ fuel complement onto the top deck of the SF-BREEZE. We consider this example

Table 12: Predicted size and duration of instantaneous LH₂ and LNG spills on solid ground from LAuV model, from Ref. [95].

Pool Characteristic	LH ₂ (17,040 kg)	LH ₂ (2,840 kg)	LNG (40,725 kg)*	LNG (18,000 kg)*
Radius (m)	42	20	49	38
Duration (s)	25	13	80	65

*assumes an LNG density of 450 g/L

to highlight the differences between LH₂ and LNG only in a worked example. The USCG does not consider such a spill a credible accident scenario because these cryogenic tanks have no history of failing in this way. The deck, with area 162.65 m², thickness 0.794 cm and mass 3483 kg would be cooled from 298 K to a minimum temperature of 168 K. The cooling of the aluminum deck is greater if LCH₄ is spilled, due to the significantly higher ΔH_{vap} value of 8.5 kJ/mole. For the same top deck, spilling an energy-equivalent mass of LCH₄ (3198 kg) cools the top deck from 298 K to a minimum of 111 K. Thus, due to the higher ΔH_{vap} value for methane, spills of LCH₄ will produce greater reductions in deck temperature.

More recently, theory was extended to account not only for the dimensions of the LH₂ pool, but also for the composition of the vapor phase immediately above the pool. Middha and co-workers [98] used a 3-D computational fluid dynamics (CFD) code named FLACS to simulate the NASA and the Verfonden and Dienhart tests for both pool formation and hydrogen content in the air above the pool and downrange. The FLACS and LAuV models were in general agreement with each other with regard to pool formation (radius, duration), although the FLACS model had higher evaporation rates and smaller pool radii due to the inclusion of thermal effects other than ground conduction. The FLACS model gave a reasonable account (within factors of 2) of the gas dispersion data that was available. The FLACS model did not take into account possible gas-phase complications such as the condensation of air components (oxygen, nitrogen) in the hydrogen cloud or perhaps freezing very close to the LH₂ pool, or in the pool itself. Condensation or freezing of atmospheric water was not included the FLACS model studies [98]. The condensation/freezing of atmospheric components (water, O₂, N₂) is at the edge of the state-of-the-art in theoretical modeling of spilled cryogenic pools.

3.2.6.4 Combustion Properties

The physical properties just discussed for hydrogen and methane are the foundation for the discussion of the combustion properties of these two fuels. Table 13 provides values for “classic” physical and combustion properties of hydrogen and methane. Some of the gaseous hydrogen properties listed are from Ref. [99].

Before discussing the combustion of these fuels by explicit ignition sources, we consider the phenomenon where releases of these gases can spontaneously ignite even in the absence of specific ignition sources.

3.2.6.5 Spontaneous Ignition

Dryer and coworkers [100] were among the first to recognize that compressed hydrogen and methane, when suddenly released, can undergo “spontaneous ignition,” also called “autoignition.” Spontaneous ignition is a particular safety concern, because it represents an ignition pathway that can persist even if one has successfully removed all explicit ignition sources from the design of a particular application involving these fuels. A number of different mechanisms have been considered [101]. The evolving picture is that spontaneous ignition arises when a sufficiently high pressure boundary between the compressed gaseous fuel and surrounding (lower pressure) air results in a shock wave that can rapidly mix and heat fuel and oxygen, leading to ignition and flame propagation fed by the continuing fuel release. Dryer and co-workers [100], along with other investigators [102], have examined spontaneous ignition as a function of release pressure, and downstream hardware configuration, which can affect the

Table 13: Physical and Combustion Property Values for Hydrogen and Methane.

Quantity	Hydrogen	Methane
Molecular Weight	2.016	16.043
Density of Gas at NTP, kg/m ³	0.083764	0.65119
Temperature to Achieve NTP Neutral Buoyancy in Air (1.204 kg/m ³), K	22.07	164.3
Normal Boiling Point (NBP), K	20	111
Liquid Density at NBP, g/L	71	422
Enthalpy of Vaporization at NBP, kJ/mole	0.92	8.5
Lower Heating Value, MJ/kg	119.96	50.02
Limits of Flammability in Air, vol%	4 – 75	5.3 - 15
Explosive Limits in Air, vol%	18.3 – 59.0	6.3 – 13.5
Minimum Spontaneous Ignition Pressure, bar	~ 41	~ 100
Stoichiometric Composition in Air, vol%	29.53	9.48
Minimum Ignition Energy, J	0.02	0.29
Flame Temperature in Air, K	2318	2148
Autoignition Temperature, K	858	813
Burning Velocity in NTP Air, m/s	2.6 – 3.2	0.37 – 0.45
Diffusivity in Air, cm ² /s	0.63	0.2

course of the shock propagation and reactant mixing. The results show that the tendency to autoignite is higher for hydrogen than methane. The minimum pressure for which spontaneous ignition has been observed, independent of downstream hardware geometry, is ~ 41 bar for hydrogen and ~ 100 bar for methane.

While spontaneous ignition can be a concern for hydrogen fuel-cell vehicles, which currently employ high-pressure (350 bar, 700 bar) hydrogen, the SF-BREEZE employs LH₂ storage of hydrogen. The highest pressure in the SF-BREEZE fueling system will be ~ 10 bar, which corresponds to the pressure relief for the LH₂ tank vent. The manifold inlet pressure to the PEM fuel cells will be ~7 bar. As a result, the overall SF-BREEZE system pressures are too low for spontaneous hydrogen ignition to come into play. The mechanistic cause of spontaneous ignition continues to be an active research topic.

3.2.6.6 *Explicit Ignition*

In order to discuss combustion caused by specific ignition sources, some definitions are in order:

Weak (Thermal) Ignition Sources: Matches, sparks, hot surfaces, open flames with initiation energy of < 50 mJ are called “weak” or “thermal” ignition sources. These are the ignition sources of accidents.

Strong (Shock Wave) Ignition Sources: blasting caps, TNT, high-voltage capacitor shorts (exploding wires), lightning are all examples of “strong” ignition sources with initiation energy of > 4 MJ. Note that strong ignition sources are ~ 10⁸ times stronger than weak initiators. This is an enormous difference in

ignition input energy. Other than lightning, strong ignition sources are the sources of intentional ignition, not accidental ignition.

Fire: Fire is the term for ordinary combustion familiar in everyday life where the flame propagates through the unburned fuel/air mix at low speeds (~ 20 m/s or less). Fires are not loud, and produce negligible overpressure in the surrounding air. Fires are produced by weak ignition sources in contact with flammable mixtures of fuel and air. Despite their familiarity, it is important from a safety perspective to remember that fires are dangerous, especially on an isolated vessel.

Deflagration: Fast combustion where the flame propagates through the unburned fuel/air mix rapidly, but at subsonic speeds (~ 100 - 400 m/s). Deflagrations can be loud, and can produce overpressures that can rupture eardrums and cause other injury. Under the right conditions, deflagrations are initiated by weak ignition sources. From a safety perspective, deflagrations are very dangerous.

Explosion or Detonation: The terms explosion and detonation are often used interchangeably, and will be so used here. Explosions are extremely fast combustion events where the flame propagates through the unburned fuel/air mix at supersonic speeds (> 700 m/s). Explosions produce loud bangs and very damaging overpressures. Direct explosions are caused by strong ignition sources with specific conditions of fuel/air mix and confinement. From a safety perspective, explosions and detonations are very, very dangerous.

3.2.6.6.1 Fires

Both H₂ and CH₄ mixtures with air ignite easily using weak ignition sources to produce fires. Fire regulations focus on the “Lower Flammability Limit” (LFL), expressed as a volume percentage (vol%):

$$\text{vol\%} = [\text{Volume (Fuel)}/\text{Volume (Fuel + Air)}] \times 100$$

The LFL is the focus of safety regulations, since the risk of fire typically comes from the accumulation of flammable gas in initially clean air. The classic values [99] for the flammability range (LFL to upper flammability limit (UFL)) for H₂ = 4.0 – 75.0 % at 298 K. The LFL to UFL of methane is = 5.3 – 15.0 % at room temperature [99]. For context, the LFL – UFL values for gasoline are 1 – 7.6% [99]. Thus, while hydrogen has a much wider flammability range than methane (making it more of a fire risk), from the perspective of building up flammable gas in an initially clean environment, hydrogen and methane have similar LFLs, with similar threshold gas accumulations that can be ignited. The minimum ignition energy for CH₄ = 0.29 mJ; that for H₂ is 0.020 mJ. Static discharges from human beings are ~ 10 mJ, so both CH₄ and H₂, when present between the LFL – UFL limits, ignite easily when exposed to with common (weak) ignition sources. Table 13 lists these combustion properties for hydrogen and methane.

As described by Cashdollar and co-workers [103], in quiescent mixtures of fuel and air, fuel buoyancy alters the LFL required for self-sustaining fires. In a self-sustaining fire, combustion advances at nearly the same speed for upward, horizontal and downward directions. Upward flame propagation is intrinsically faster than other propagation directions because combustion products are hotter and less dense than the original fuel and air mixture. However, for sufficient concentrations of fuel, the combustion is hot enough that flame propagation is facile in all directions. Hydrogen mixtures ignited at

4 % produce very little heat, and flame propagation is almost exclusively upward. Thus, for a spherical hydrogen/air mixture, weak initiation at the sphere center at the LFL will only produce combustion for a relatively small upper slice of the spherical volume, producing fire that cannot sustain itself to the point of complete combustion of the fuel. For sustained hydrogen fires, the hydrogen/air mix needs to be ~ 8% for combustion to propagate in all three directions with complete combustion of the fuel [103]. Since methane is less buoyant than hydrogen, buoyancy effects are correspondingly less, and full-three dimensional flame propagation is achieved at a methane/air mix of ~ 6%, up from the classic LFL value of 5.3 %.

Interestingly, intentional active mixing of the fuel/air mixture can largely counteract the effects of buoyancy. In some of the experiments of Cashdollar et al. [103], a mixing fan produced flows of order 1 – 1.5 m/s along the fan rotation axis. In this mildly turbulent condition, the threshold for a self-sustaining fire in hydrogen returned to 4%. For methane, for which buoyancy effects are small to begin with, mild turbulent mixing produced the same ignition concentration threshold as quiescent conditions. The effect of the active mixing is to introduce a velocity element that can overcome the influence of buoyancy and promote mixing, which produces hotter burning, and faster flame speeds that propagate well in all three directions.

In typical accidental scenarios involving slow releases of hydrogen in the SF-BREEZE fuel cell rooms, we anticipate the conditions will correspond more closely to the quiescent scenario, suggesting a LFL for sustained combustion in the fuel cell rooms to be closer to ~ 8%. Overall, from the point of view of fire risk coming from fuel release into initially clean air, hydrogen and methane have very similar ignition risks because their LFLs are similar. Laboratory experiments have shown that the LFL holds even if the ignition source is highly intermittent. Schefer and coworkers [104] have shown that in ignition tests on hydrogen and methane turbulent jets using a 100-mJ laser with a 9-ns pulsewidth, ignition is not possible unless the instantaneous concentration of fuel present at the time of the laser pulse is above the classic LFL.

3.2.6.6.2 Explosion and Detonation

Hydrogen and methane can both detonate given the right conditions of fuel/air mixture, confinement and strength of ignition source. Ng and Lee [105] have discussed the explosion risk for hydrogen in the transportation setting. The lower explosion limit (LEL) of H₂ at room temperature (% by volume) - upper explosion limit (UEL) = 18.3 – 59.0 % at room temperature [99]. The LEL to UEL of methane is = 6.3 – 13.5 % at room temperature [99]. Thus, hydrogen has a much wider explosive range than methane, making it more of an explosion risk in general. From the perspective of building up flammable gas in an initially clean environment, the LEL of methane is reached considerably sooner than that of hydrogen.

In the SF-BREEZE design, hydrogen release is a concern for two locations. On the top deck where the LH₂ tank is situated, we have an essentially unconfined environment in which a release of H₂ would be free to disperse upward without blockage. The main deck holds the PEM fuel cells, which are distributed into a Starboard (right, facing forward) and Port (left, facing forward) Fuel Cell Rooms. In these fuel cell rooms, there exists a confined situation where hydrogen (if released) would enter an enclosed room, albeit with installed ventilation providing 30 room exchanges of air per hour. We examine combustion

beyond normal fires to include assessment of explosions and deflagrations with varying degrees of confinement.

The A.D. Little Company evaluated the practical explosion risk from large-scale releases of hydrogen in confined and unconfined environments in a series of experiments and modeling studies for the U.S. Air Force and the NASA Lewis Research Center over the period 1960 – 1982 [78-80]. These impressive and comprehensive tests represent the first modern scientific investigations of the consequences of spilling and igniting large quantities of LH₂. The original work, published in 1960 [78] with aspects reported again in 1964 [79], reported the combustion of stoichiometric mixtures of hydrogen and air confined in large balloons with diameters ranging from 5 to 8 feet. Even though clearly “confined,” such balloons were a departure from the highly confined small tube experiments that had been used up to that time, and gave an indication of combustion properties in “free space.” For the 5-ft balloon, detonation of the stoichiometric H₂/air mix required a strong ignition source (2 grams of pentolite explosive). This data revealed that a three-dimensional shock wave could be propagated in “free space” in a H₂/air mix if a sufficiently strong initiator were used. Importantly, ignition of these confined H₂/air stoichiometric mixtures via weak ignition sources (sparks) yielded only fires with no measureable overpressure.

The A.D. Little investigators assessed if a larger volume balloon could provide a sufficient path length to allow a transition from fire to deflagration to detonation. Using an 8-foot diameter balloon containing a stoichiometric mixture of hydrogen and air, ignition by weak spark sources produced again only fire with negligible overpressure. The conclusion from this work is that both confinement and explosive initiation are required for the direct explosion of confined hydrogen/air mixtures in which explosion occurs instantaneously. Furthermore, in free space (with no obstacles present), over a distance of ~ 4 feet (the balloon radius), there is no transition of the combustion from fire to deflagration to detonation using weak ignition sources.

In the LH₂ spill tests using 32 gallons in which a vapor cloud forms in the open (no confinement of any kind), the Little researchers found no detonation or tendency towards detonation even when strong explosive initiators were used to ignite the vapor cloud. Since detonation using explosive charges was observed in the 5-foot balloon tests, they concluded that the vapor clouds above real spills had non-ideal mixing that inhibits direct detonation. These observations led the authors to conclude [78], “even with shock-wave initiation, detonation is unlikely of the hydrogen-air cloud from a large-scale spill.”

Summarizing these early tests of practical hydrogen combustion risks, direct detonation requires strong ignition sources, confinement, and hydrogen/air mixes within the LEL - UEL range. Weak ignition sources produce fires even when the hydrogen/air mix is within the explosive range and confined in a balloon. Ignition of vapor clouds above sizeable LH₂ releases using strong or weak ignition sources produces only fires. Experimental results for ordinary combustion and detonation were consistent with the LFL – UFL and LEL – UEL ranges listed in Table 13.

For LNG, ignition tests over LNG pools conducted at Sandia National Laboratories as part of the “Phoenix Program” [106] gave similar results. Ignition of LNG vapors above pools with weak ignition sources produced fires, not deflagrations or explosions.

These experimental results from the 1960s already help frame the hydrogen fire safety issues for the SF-BREEZE. On the top deck where the LH₂ is stored, fire is the only credible combustion risk, (rather than detonation, explosion, or deflagration) because of the lack of confinement on the top deck and the absence of strong ignition sources. In the confined Starboard and Port Fuel Cell Rooms, direct detonation is not possible because of the lack of strong (intentional) ignition sources. However, we need to examine these fuel cell rooms more carefully to assess the role of confinement and internal obstacles on the acceleration of ordinary fires to deflagrations, with possible subsequent deflagration to detonation transition (DDT).

In the decades since the 1960s, there has been enormous growth in the scientific understanding of hydrogen and methane flammability, deflagration and detonation, which supports and helps understand the A.D. Little test results. This foundational understanding is essential for the design of hydrogen technology systems [105]. Matsui and Lee quantitatively determined [107] the minimum ignition energy required for direct detonation of hydrogen/air and methane/air mixtures and how this threshold energy varies with the fuel/air mix. The minimum ignition energy occurs near the stoichiometric mix (29.53 % for H₂, 9.48 % for methane), and is 4.16×10^6 J for hydrogen and 2.28×10^8 J for methane.[107] The value for methane is orders of magnitude larger than any other hydrocarbon, making methane exceptionally insensitive to direct detonation. The minimum detonation energy for both hydrogen and methane are $\sim 10^8$ times larger than the energy required to start normal burning-- an enormous ignition energy requirement essentially precluding direct detonation of hydrogen or methane in accident scenarios.

So far, we have considered two physical limitations to the direct detonation of hydrogen or methane, namely the fuel/air mixture has to be within the range LEL – UEL and a strong (shock wave) initiator is required. A third physical requirement has been discovered over the past several decades: the combustion volume must be larger than the “detonation cell size” of the explosive mixture. As discussed previously by Ng and Lee [105] and Yang [108], it has been experimentally observed that detonations form distinctive physical patterns called “detonation cells” which can be observed in experiments as a “smoke foil” record [109]. For a detonation to occur, the spatial extent of the reacting system must be larger than one cell dimension. For a stoichiometric mix (equivalence ratio = 1) for hydrogen, at room temperature and atmospheric pressure, the detonation cell size is ~ 1.5 cm [109]. The detonation cell size for methane at room temperature and atmospheric pressure is ~ 33 cm [109]. For the SF-BREEZE Top Deck, and the Starboard and Port Fuel Cell Rooms, the physical dimensions are significantly larger than these detonation cell sizes, meeting the geometry requirement imposed by the detonation cell size. The detonation cell size determines how wide experimental tube reactors must be in the transverse direction (normal to the flame propagation) in order to study tube-based detonations in these gases. If the tube diameter is ~ 13 times the detonation cell size, then a confined planar detonation can transform into an unconfined spherical detonation wave upon exit from the tube [109]. The larger detonation cell size for methane requires using significantly larger tubes or tunnels for experiments than required for hydrogen, making it technically more challenging to examine detonation phenomena in methane.

3.2.6.6.3 Deflagration to Detonation Transition (DDT)

Although the absence of strong (intentional) ignition sources precludes the direct detonation of hydrogen and methane in accident scenarios, under certain circumstances it is possible to have a detonation with weak ignition sources given a fuel/air mix within the LEL – UEL range, confinement and obstacles or internal structures within the reacting volume. Unlike direct detonation, which requires a strong ignition source, this type of explosion can start with a normal fire. In the confined/obstructed environment, the speed of the combustion accelerates over time and distance to a deflagration due to turbulent mixing of the unburnt fuel-air mixture near the obstacles. With further acceleration, the deflagration transitions to a detonation, producing a Deflagration to Detonation Transition (DDT). For H₂, DDT can only occur for 12% fuel /air mix or higher. Both H₂ and NG can experience DDT, although it is easier for hydrogen. Note that for the A.D. Little balloon tests, which showed no acceleration of combustion for either the 5-foot balloon or the 8-foot balloon, there were no internal structures or obstacles which would have promoted a DDT.

A cutaway view of the Main Deck of the SF-BREEZE is shown in Figure 33 . The SF-BREEZE Starboard and Port Fuel Cell Rooms each measure 7.4 m long x 5.1 m wide x 2.7 m tall. These rooms each hold twenty 120 kW fuel cell racks each, which constitute obstacles and potential weak ignition sources for the present discussion. If there were to be a significant hydrogen leak into one of these fuel cell rooms that could not be handled by the ventilation system, a legitimate question is whether or not the hydrogen buildup, presence of confinement, obstacles and ignition sources could potentially lead to a fire that evolves into a DDT.

An early and particularly illuminating series of DDT tests for H₂/air mixtures was performed at Sandia in the early-mid 1980s in the “FLAME Facility” [110]. Figure 34 gives a diagram of the FLAME facility. The FLAME tunnel was 1.83 m wide, 2.44 m tall and 30.48 m long, and constructed of heavily reinforced concrete. The transverse dimensions are similar to the 5.1 m x 2.7 m transverse dimensions of the SF-BREEZE Starboard and Port Fuel Cell Rooms. Sherman et al. placed flow obstacles in the tunnel, blocking one third of the cross section of the tunnel (33% blockage ratio), and monitored the speed of combustion as it traversed the FLAME tunnel using thermocouples. The experiments were conducted at atmospheric pressure and ambient temperature.

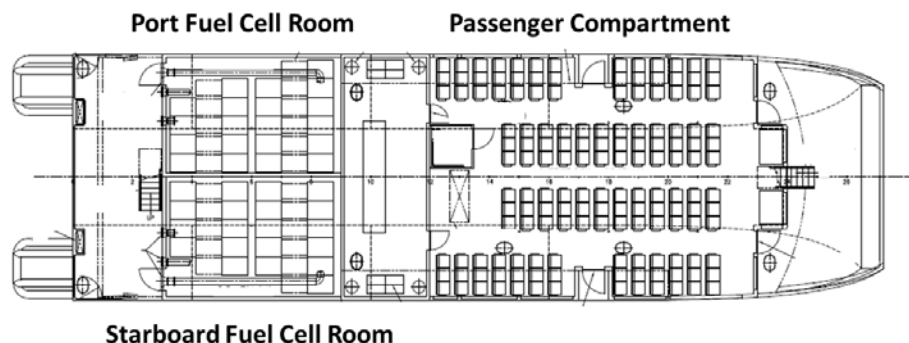

Figure 33: Cutaway view of the Main Deck of the SF-BREEZE. The PEM fuel cells are distributed into a Starboard Fuel Cell Room and a Port Fuel Cell Room, with ~ 20 fuel cell racks in each room. The Passenger Compartment holds 150 passengers. The “beam” (width) of the SF-BREEZE is 10 m.

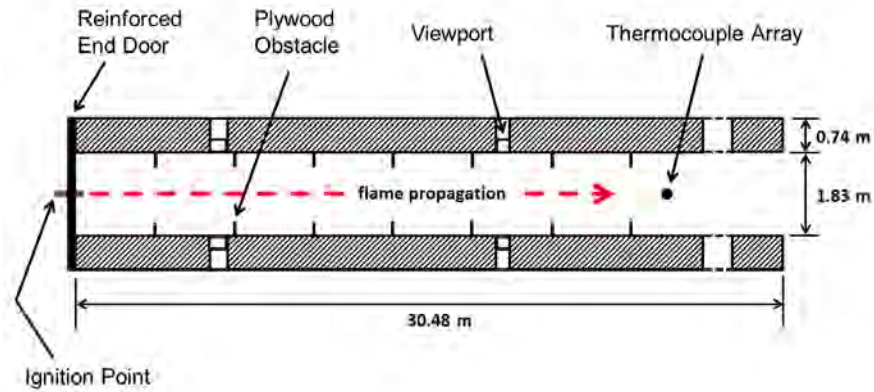

Figure 34: Schematic of the Sandia FLAME facility. Figure is reproduced with modification from Reference [110].

Figure 35 shows results for the planar flame speed as a function of distance downrange from the ignition end for various H_2 /air mixtures in the tunnel with obstacles removed [110]. This figure shows that for hydrogen concentrations of 12.9% or less, the flame velocities are slow, less than ~ 20 m/s. There is no change in the flame velocity as the flame propagates down the tunnel, and thus no flame acceleration with run distance. This is the propagation of an ordinary fire.

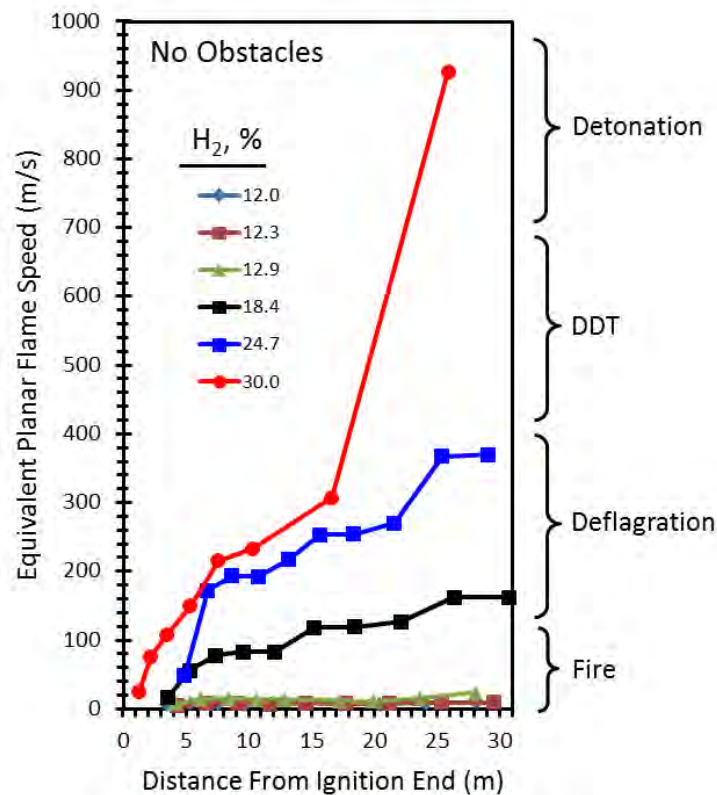

Figure 35: Planar flame speed plotted against distance from the ignition end in FLAME experiments. Obstacles were removed from the tunnel for these measurements. The figure uses data reported in Reference [110].

However, given confinement, significant downrange run distance and an increase in the hydrogen concentration to 18.4%, one can see in Figure 35 that the flame velocity increases with distance from the ignition end, reaching 162 m/s at the end of the tunnel. Increasing the hydrogen concentration to 24.7%, the flame accelerates to 367 m/s at 25 meters. Flame speeds in the range 100 – 400 m/s are considered “deflagrations” in comparison to the slower “fire” speeds at ~ 20 m/s or less. For the 30% mix, a near-stoichiometric mix of hydrogen and air, one sees significant acceleration to 307 m/s at a run distance of 16.6 meters. Thereafter a dramatic jump in flame speed occurs, and the velocity measured 26 meters down the tunnel is a supersonic 927 m/s. This represents the transition from deflagration to detonation. The entire figure shows how confinement, increasing hydrogen concentration and run distance can cause acceleration from normal fire to deflagration to detonation in relatively confined spaces even if obstacles are absent.

Figure 36 shows the same experiment, only with obstacles placed in the flame propagation path. The presence of obstacles induces an acceleration of the flame velocity at H₂/air concentrations that would otherwise not experience flame acceleration. Given a run-up distance of 10 meters, the flame speeds for concentrations greater than 12% accelerate from normal fire speeds to deflagration speeds (~ 100 – 400 m/s). With more run time and distance, even at mixtures as low as 15.5%, very fast deflagration velocities of order 600 m/s are observed if obstacles are present. A key finding from this work is that hydrogen concentrations less than 12% cannot support DDT even with obstacles present. The lowest H₂/air mix for which DDT was observed in the Sandia tests was 15%. Other studies [111] of large-scale hydrogen/air mixtures have found a lower concentration threshold for hydrogen DDT to be ~ 12.5%.

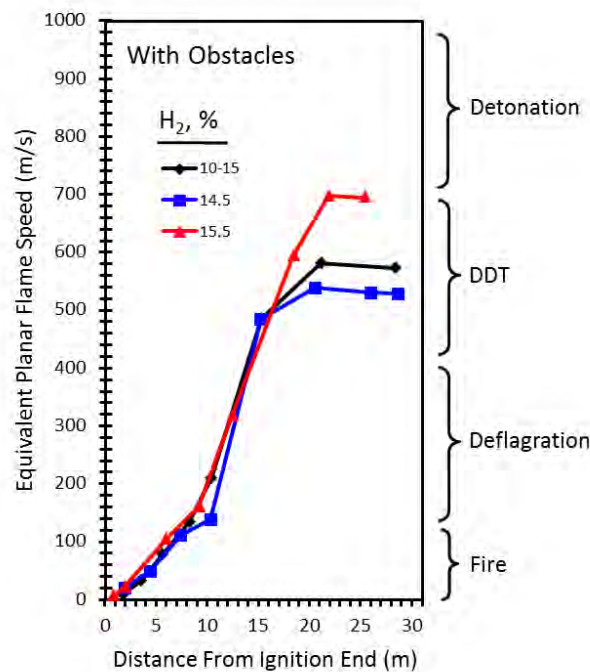

Figure 36: Planar flame speed plotted against distance from the ignition end in FLAME experiments. Obstacles were placed in the tunnel for these measurements. The figure uses data reported in Reference [110].

Recent studies using sophisticated experimental and theoretical approaches have revealed the basic mechanism for DDT [105, 112-115]. Flame acceleration requires a feedback mechanism between the advancing (initially low-speed laminar) flame and the unburnt fuel/air mix ahead of the flame. Consider the tunnel geometry of the FLAME apparatus in Figure 34. At any given position and moment in time, the flame influences the temperature and pressure in the unburnt flow field ahead of the flame (towards the right in Figure 34). This interaction produces small turbulent structure in the unburnt flow field. When the flame advances and engulfs this turbulence, the flame will burn hotter because the turbulence increases the area of the boundary between flame and unburnt fuel/air (i.e. the flame area increases), and the combustion itself becomes hotter because the fuel and air are better mixed. This increased flame area and temperature affects the new unburnt flow field ahead even more than before, which in turn further increases the combustion energy when, at a later time and downrange distance, the flame encounters this new turbulent area. This feedback continues, increasing the flame speed until the flow reaches the sonic limit consistent with the composition of the combustion products. When the flame speed approaches the speed of sound, shock waves form and shock-flame interactions become an important mechanism for flame wrinkling and further turbulence generation. The deflagration transitions to a detonation at this point.

The role of obstacles is to increase the rate of formation of turbulent structures. For example, obstacles can induce vortices in the upstream flow field, reminiscent of the turbulent structures issuing from aircraft wingtips. As flow moves past the edge of an obstacle, the shear layer can roll up into a spiraling turbulent structure that provides the feedback to the flame needed for an accelerated flame velocity as the flame moves down the tunnel.

Recently, Johansen and Ciccarelli [115] have captured the creation of a turbulent flow field ahead of the advancing flame for stoichiometric methane-air mixtures using a high-speed schlieren video system. The images show directly how the advancing flame affects the unburnt flow field ahead of the flame, the creation of turbulence at obstacles, and how this turbulence alters the combustion within the flame once the flame passes through the turbulent region. Such experiments have also been successfully modeled theoretically [114].

Figure 35 and Figure 36 reveal the importance of “run up distance” in the DDT phenomena. For the Sandia FLAME experiments, 10 meters of run-up distance is needed to attain deflagration speeds of 100 – 200 m/s. In the SF-BREEZE design, the Starboard and Port Fuel Cell Rooms have dimensions 5.1m wide x 2.7 m tall x 7.4 m long. Distributing the PEM fuel cells amongst these two rooms not only creates redundancy in the vessel power system (as required by U.S. Coast Guard regulations), but also limits the run-up distance available to a hydrogen fire should one break out in one of these rooms.

The studies of Groethe and coworkers [112] demonstrate the importance of limited “run-up” in limiting the acceleration of hydrogen combustion caused by obstacles. Their experimental setup is shown in Figure 37. A hemispherical tent of radius 5.7 meters (300 m³ total volume) was outfitted with a weak ignition source (40 J spark) at the hemisphere center, along with 18 cylindrical aluminum cylinders measuring 0.46 m diameter by 3 m height. The cylinders were arranged around a central point of

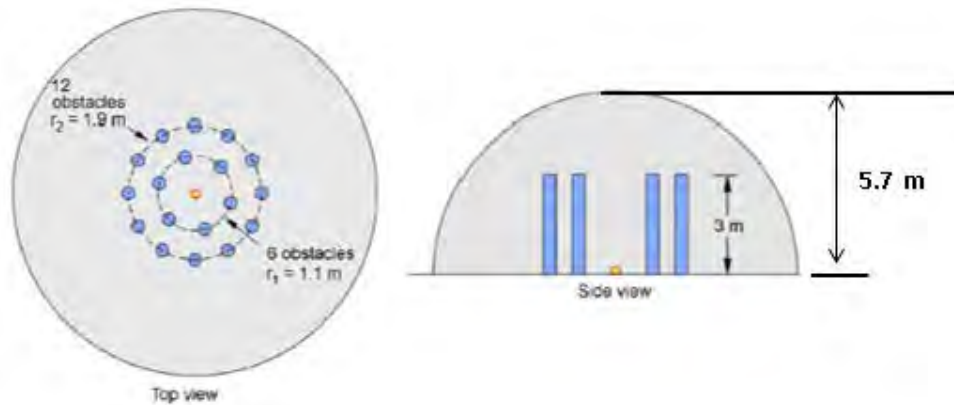

Figure 37: Experimental setup for the experiments reported in Reference [112]. Figure reproduced from Reference [112].

ignition as shown in the Figure 37. Experiments on hydrogen combustion were conducted with and without the cylinders present to assess the role of obstacles in producing DDT in this geometry.

Figure 38 shows optical video images of the combustion using a 30% hydrogen-air volumetric mix [112]. These images show the flame velocity with obstacles present was ~ 85 m/s, consistent with a fast laminar flame. The form of the flame looks like an ordinary fire. Pressure sensors outside the hemispherical tent showed no difference between combustion events with or without the obstacles placed inside. A reasonable explanation for the lack of obstacle-induced acceleration is that the geometry of Figure 37 does not provide sufficient run-up distance. With only 5.7 m of run-up available, there is insufficient distance for obstacle-induced flame acceleration to occur.

Although the tent provided confinement and an optimal near stoichiometric 30% H_2 /air mix, there was no detonation or explosion. This is because a weak ignition source was used. In one experiment, the researchers replaced the weak ignition source with 10 g of C-4 high explosive to initiate the combustion. With a strong ignition source, confinement and a H_2 /air mix in the LEL–UEL range, all the necessary ingredients are in place for a detonation. Figure 39 shows high-speed video images of the detonation.

The time scales in Figure 39 are much shorter than for Figure 38. The video images show that the flame velocity is 1980 m/s, well into the detonation range. Also, note the completely spherical shape of the detonation wave. In a detonation, the flame front advances so rapidly that the fuel/air mixture has essentially no time to move in response to the combustion event. Over the 5088 microseconds of the detonation event, the gas is essentially motionless, with no turbulent structures developed. A nearly perfectly spherical combustion front is created. In contrast, using a weak initiator in Figure 38, over the 65-millisecond duration of the photography the gas volume has time to react to the combustion, producing irregular flame structures. The work of Goethe is very educational and helps to develop an intuitive picture of the difference between ordinary combustion and a detonation, in addition to revealing how short run distances can limit DDT even when obstacles are present.



Figure 38: High-speed optical video images of hydrogen combustion for a 30% hydrogen/air mixture, ignited with a 40 J spark. Figure reproduced from Reference [112].

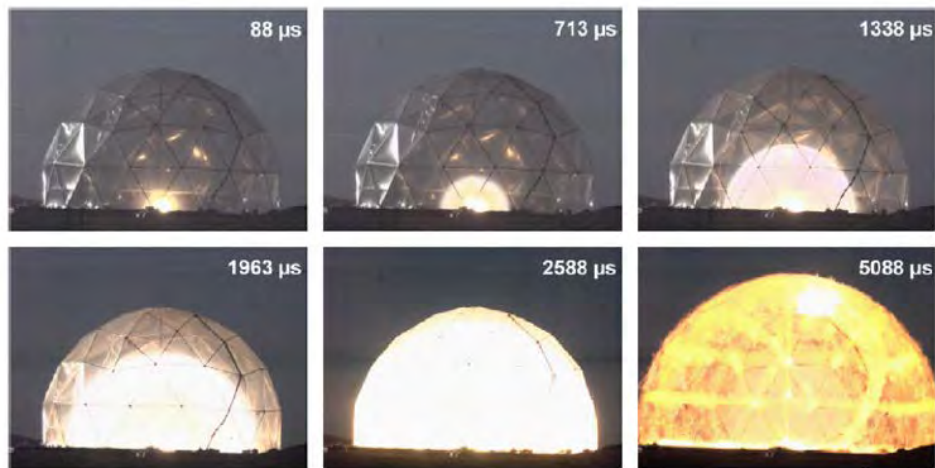

Figure 39: High-speed optical video images of hydrogen combustion for a 30% hydrogen/air mixture, ignited with 10 grams of C-4 high explosive. Figure reproduced from Reference [112].

3.2.6.7 Pool Fires

One of the striking differences between hydrogen and natural gas is the radiant nature of their fires. When hydrogen burns, the product of combustion is primarily water vapor, with other species such as OH and H radicals, and HO₂ and H₂O₂ produced in trace (< 1 %) amounts. As a result, the vast majority of thermal radiation from hydrogen fires originates from vibrationally excited water molecules. In contrast, when methane burns, although some water is produced, most of the thermal radiation comes from carbon-containing species, and especially carbon soot, which is an efficient radiator of thermal energy. As a result, the thermal radiation emitted from methane fires is (on a fuel LHV basis) 2 - 3 times higher than for a hydrogen fire. This property is quantified as the “radiant fraction,” which gives the fraction of fuel combustion energy that is released as radiation. We estimate that for a “pool fire” involving combustion of the entire 1200 kg of the LH₂ fuel complement, the radiant fraction would be 0.045. A pool fire burning an energy equivalent amount of methane (3198.9 kg) would have a radiant fraction of 0.10. Thus, the methane fire would release 2.2 times more radiant energy than a hydrogen fire for the same combustion energy.

Because a hydrogen fire is emitting infrared (IR) radiation in the vibrational (bending, stretching) modes of water, residual water in the atmosphere is the perfect absorber (and re-emitter) of radiation from hydrogen fires. Thus, humidity in normal air significantly reduces the transmission of thermal radiation issuing from hydrogen fires. Gerritsma and Haanstra [116] have made quantitative measurements of the IR transmission of atmospheric air at room temperature and a relative humidity of 62%. Over a 4.7-meter path length, the average transmission for the water IR bands through the air is 68.2%. Thus, 31.8% of the thermal radiation issuing from a hydrogen fire over a 4.7 m distance would be blocked by atmospheric water vapor [116]. The atmospheric absorption of thermal radiation from a methane fire would be significantly less.

This difference in radiant energy has consequences for the impact fire has on surrounding structures and personnel. In their 1982 study [80], A.D. Little calculated the closest approach one could get to a pool fire of LH_2 and LCH_4 and still not suffer a thermal skin injury (whose threshold was assumed to be 5 kW/m^2) for varying quantities of fuel burned. For a fuel heat content of 144 GJ, corresponding to 1200 kg of LH_2 and 3198.9 kg of LCH_4 , calculations were made of the closest approach to the fire in the horizontal direction at grade. For 1200 kg of burning hydrogen, the closest approach is $\sim 19 \text{ m}$. For LCH_4 , the closest approach is $\sim 58 \text{ m}$. One can get closer to a hydrogen fire because it radiates less thermal energy and water vapor in the atmosphere efficiently absorbs and redistributes the IR radiation from a hydrogen fire. These two effects more than compensate for the slightly higher flame temperature of hydrogen compared to methane (Table 13).

To bring together the concepts that have been discussed thus far for fuel buoyancy, pool formation, fuel combustion, and fire radiation, it is useful to compare and contrast two hypothetical accident scenarios where the entire 1200 kg LH_2 fuel complement of the SF-BREEZE and the energy equivalent in LNG is instantaneously spilled and ignited on the Top Deck of the vessel. This is a “pool fire” scenario, which has been the subject of many studies given its importance in fuel and fire safety [117-122]. It was of initial interest to the SF-BREEZE project, because aluminum was used as the material for the top deck (to reduce weight), but aluminum is not as structurally strong as steel in traditional (diesel) fires, which initially raised some concerns. Indeed, as specified by Alcan [123], “if a load-bearing structure made from age hardened aluminum alloys is exposed to temperature above $150 \text{ }^\circ\text{C}$ for several hours, then the residual mechanical characteristics of components made from alloys belonging to the 6000 series will have to be tested after fire.” It turns out that the U.S. Coast Guard does not consider the spilling and ignition of the entire fuel complement to be a credible accident scenario for the SF-BREEZE, because there is no history of LH_2 tanks catastrophically failing in this way. Nonetheless, considering this scenario pulls together the hydrogen and methane physical and combustion properties discussed thus far into a worked example.

The energy produced by burning 1200 kg of H_2 is 143,952 MJ, using a LHV value of 119.96 MJ/kg for hydrogen. In the 1982 A.D. Little study [80] of crash scenarios for LH_2 aircraft, predictions were made for pool diameters, duration and flame heights for such an accident. According to the Little study, 4.5% of the hydrogen combustion energy is converted to thermal radiation (radiant fraction = 0.045). Thus, the thermal energy radiated from burning the 1200 kg of hydrogen from the SF-BREEZE would be 6,477.8 MJ. The Little modeling work predicts that spilling 1200 kg (16.90 m^3) of LH_2 on solid ground



Figure 40: A 10-m diameter LNG pool fire from the Sandia Phoenix Tests. Figure reproduced from Reference [117].

would result in a pool of diameter 15 m (radius = 7.5 m), yielding a pool fire of duration 7.2 seconds, and a flame height of 105 m. These predictions for LH₂ pool size and duration are consistent with our earlier estimates based on the work of Verfonden and Dienhart [94, 95] which suggested a pool radius of ~ 8 m and a duration of 6 seconds for the spilling of 1200 kg of LH₂. Given these dimensions for the fire column, and the 6477.8 MJ of radiant energy, the emissive power of the hydrogen fire would be 169.8 kW/m² averaged over the entire flame surface during the fire duration of 7.2 seconds. These estimates for the pool diameter and duration for an LH₂ pool fire are consistent with estimates inferred from the cryogen spill investigations and modeling of Verfondern and Dienhart [94]. The result of the instantaneous spill and ignition is to produce a very tall fire. Tall fires do exist, as shown in Figure 40 for a 10-m diameter LNG (consisting of 99% methane) pool fire on water from the recent Sandia Phoenix tests [117].

The average concentration of hydrogen within the 105 m tall and 15 m diameter combustion column would be 41.9%, well within the LFL – UFL range for hydrogen. The radiant fraction estimated by A.D. Little for hydrogen is in reasonable accord with the expectations for the flame residence time (13 ms) calculated for a hydrogen fire column of the dimensions given.

The combustion column is so tall because hydrogen gas is so buoyant. As a result, most of the thermal radiation emitted from the flame surface is directed well above and away from the vessel, with only a small fraction directed downward towards the deck. The percentage of the entire flame area at the base of the fire column is 3.3% (area of the bottom circular surface of the cylindrical column as a fraction of the total area of the entire cylindrical column). Therefore, thermal radiation directed from the fire to the deck is 213.7 MJ. None of this IR radiation is absorbed directly by the LH₂ pool, because hydrogen is inactive in the IR. The lack of IR absorption by LH₂ pools is an important consideration for quantitative models of LH₂ pool fires. The 213.7 MJ of IR radiation directed downwards passes through the LH₂ pool and strikes the aluminum deck that can absorb the IR radiation. Assuming a conservative (more highly absorbing) emissivity value of 0.4 for aluminum [124], the total thermal energy absorbed by the aluminum top deck is 85.5 MJ (0.4*213.7).

As described in Section 3.2.6.3, when LH₂ spills (instantaneously in this example) onto the top deck of the SF-BREEZE, the hydrogen cools the aluminum deck via the enthalpy of vaporization of the liquid. For a conservative estimate (one that leads to the least cooling, and therefore the highest final temperature for the aluminum) we assume a liquid initially at 29 K under pressure, for which the enthalpy of vaporization is 323.9 kJ/kg. Thus, 388 MJ is needed to fully evaporate the 1200 kg of LH₂ fuel. With the dimensions of the top deck being 0.794 cm thick, with an area of 162.5 m² (determined from the design drawings of the vessel), there is sufficient thermal energy contained in the structure to evaporate all the LH₂. Using the temperature-dependent heat capacity of aluminum, we estimated the final aluminum deck temperature induced by spilling the cryogenic LH₂ fluid would be 168 K.

With 85.5 MJ of radiant energy available to warm up the deck, combined with the energy required to evaporate the LH₂ (which initially cooled the deck) we calculate the final temperature to be 199 K after the sequential LH₂ spill and fire. Thus, through spilling and igniting the LH₂ fuel load on the SF-BREEZE, the final temperature of the deck is below room temperature. There is no structural risk to the Al deck, since the temperature during the spill/fire never approaches 150 °C.¹⁶ There is no risk of brittle fracture either, since aluminum is not susceptible to brittle fracture [97].

One can perform a similar analysis using an energy equivalent amount of LCH₄, namely 3198.90 kg of LCH₄. Assuming a fuel LHV of 45 kJ/kg to be representative of LNG, the energy produced by burning 3198.9 of methane is 143952 MJ (same as for hydrogen). Methane fires emit more thermal radiation, since the fuel is based on carbon. We adopt a radiant fraction of 0.10 for methane combustion. Thus, the thermal energy radiated from burning the 3198.9 kg of methane would be 14395.2 MJ. Scaling results from the analyses of Verfondern and Dienhart [94] we estimate this quantity of LNG would occupy a diameter of 14.0 m and the pool would last 12.3 seconds on the ground. If the fire column height were 87 m (shorter than for H₂ because methane is less buoyant), then the flame surface, for this duration, would have an emissive power of 286 kW/m², which is what has been measured in the Phoenix LNG pool fire tests [117].

Note that the average concentration of methane within a column that was 87 m tall and 14 m in diameter would be 25%, outside the UFL range for methane. However, there is little doubt the combination of ignition and density fluctuations within the vapor above the pool would lead to full column combustion. The radiant fraction of 0.10 estimated for methane is in accord with the expectations (34 milliseconds) for the flame residence time calculated for a methane fire column of the dimensions given.

The percentage of the entire methane flame area at the base of the column is 3.7%. Therefore, thermal radiation directed from the fire to the deck is 533 MJ. This value is higher than for hydrogen because of the higher radiant fraction for methane combustion. Unlike the case for hydrogen, LCH₄ is capable of absorbing IR radiation because CH₄ vibrations do involve the creation of a dipole moment. We will ignore this for the present, and assume that all the IR is directed onto the aluminum deck. Assuming an

¹⁶ 150 °C is the temperature at which exposure for several hours may lead to changes in structural integrity – refer to narrative five paragraphs above.

emissivity of 0.4 for the IR emissivity of aluminum, the total thermal energy absorbed by the aluminum deck is 213 MJ.

When LNG spills (instantaneously in this example) on the top deck of the SF-BREEZE, the liquid methane cools the aluminum deck via the enthalpy of vaporization of the liquid. Using the ΔH_{vap} value for LCH_4 of 531 kJ/kg, to evaporate 3198.90 kg of LCH_4 requires 1698 MJ of thermal energy from the SF-BREEZE Al deck. This is much larger than the 388 MJ needed to vaporize the LH_2 , because the stronger intermolecular forces for methane lead to its higher enthalpy of vaporization. Because the ΔH_{vap} of LCH_4 is so much larger than for LH_2 , the Al deck will be cooled down to 111K, the boiling temperature of LNG, and there will still be LNG left over.

With 213 MJ of radiant energy available from the methane fire to warm up the deck, combined with the energy required to evaporate the LNG (which initially cooled the deck) we can calculate the final temperature to be 198 K, again below room temperature. This is actually quite similar to that calculated for LH_2 (199 K). As was the case with LH_2 , there is no structural risk to the Al deck, since the temperature during the spill/fire never approaches 150 °C. There is no risk of brittle fracture, since aluminum does not suffer this materials failure mode [97].

The LH_2 and LNG spill/ignition scenarios produce very similar final temperatures (199 K for LH_2 , 198 K for LNG). This is because the 1200 kg of LH_2 cools the 0.794-cm thick aluminum deck less (via its lower ΔH_{vap}) and heats the deck less (via its lower radiant fraction) than the case for spilling and burning 3198.9 kg of LNG. Liquid methane cools the deck significantly more (via its larger ΔH_{vap}), but also warms the deck significantly more (via its larger radiant fraction), with the two effects balancing to produce a similar final aluminum deck temperature as for LH_2 .

3.2.6.8 The Hindenburg

When considering hydrogen for a new application, for example as a propulsion fuel in the high-speed ferry SF-BREEZE, the existing community for that application invariably references the *Hindenburg* accident in 1937 as a concern for hydrogen use in general. Most people have seen the pictures or the newsreel images from the accident that tragically claimed the lives of 35 people. In discussions with the maritime community, a common misconception is that the *Hindenburg* exploded. With the hydrogen combustion properties now sufficiently described, one can look again at the *Hindenburg* accident with an eye toward the combustion phenomena involved.

It is clear from the photographic record of the event (for example Figure 41) that the accident consisted of a fire, not an explosion. Unlike explosions that are extremely fast (see Figure 39), the airship initially stayed aloft while burning. This is consistent with a fire. The burning airship descended tail-first, because there was still unburned hydrogen in the nose of the airship, due to the relatively slow flame velocity. This also is consistent with a fire. Since the airship provided confinement of the hydrogen, we can conclude that a weak ignition source initiated the hydrogen combustion, not a strong ignition source that would have produced a detonation. Furthermore, there is no evidence for a DDT from the film record of the event. The lack of explosion and the presence of an ordinary fire do not make the accident any less tragic. Fires are dangerous too, and all effort needs to be directed to preventing hydrogen-

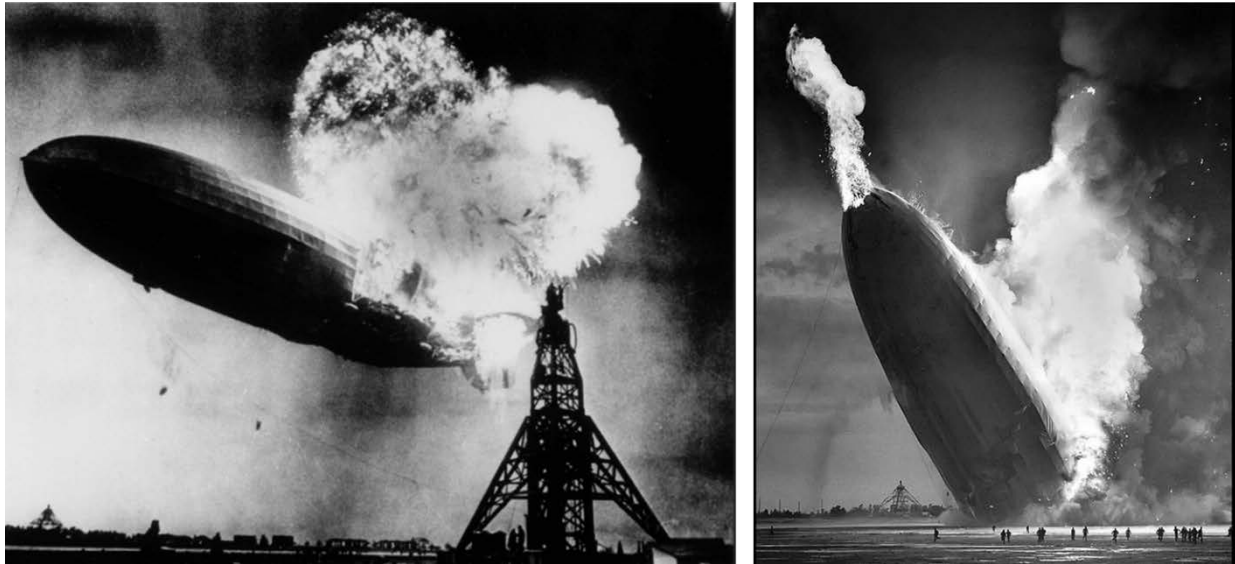

Figure 41: Photographs of the *Hindenburg* disaster (from public record).

based fires. Vessel designs that prevent fires also work to prevent other more dangerous events such as DDT or direct detonation.

In discussions with the maritime community, it has also been helpful to provide context for the *Hindenburg* accident. The *Hindenburg* held ~15 times more H_2 than the SF-BREEZE. The method of storing hydrogen for the airship (rubberized gas bags) bears no resemblance to the highly engineered DOT-approved stainless steel LH_2 tanks in use on the roads today and envisioned in the SF-BREEZE design. Over the past 60 years, NASA has mastered the use of hydrogen, the “signature fuel” of the American Space Program [125]. (Although there have been two tragic accidents involving the space shuttles Challenger and Columbia, these accidents did not originate from the onboard storage of LH_2 .) The Space Shuttle held 102,900 kg of LH_2 , 86 times more than the SF-BREEZE [126]. Through science-based safety engineering and a sound understanding of hydrogen physical and combustion phenomena, hydrogen technology can be used safely in maritime applications. The 50-year record of transporting LNG throughout the world is excellent: 8 accidents involving spills, with no fires and no fatalities [127]. Since LH_2 and LNG are very similar in their physical and combustion properties, minor augmentation of the effective international regulations for LNG transport will enable regulated and safe use of hydrogen fuel cell technology in maritime applications such as the SF-BREEZE high-speed fuel-cell ferry.

3.2.6.9 Summary

The safety-related physical and combustion properties of LH_2 and LNG were reviewed in the context of the SF-BREEZE high-speed fuel-cell ferry. Due to weaker interaction between molecules, LH_2 is colder than LNG, and evaporates more easily. If spilled, LH_2 cools surfaces less than LNG due to its smaller enthalpy of vaporization, ΔH_{vap} . LH_2 spills are smaller and short-lived compared to LNG spills. LH_2 pool dispersal times for the full 1200 kg of LH_2 spilled on the SF-BREEZE deck would be about 6 sec, with a cryogenic pool radius of about 8 m. LH_2 and LNG are similar in their combustion properties, with

hydrogen having a wider flammability range. Vapors of both are easily ignited by weak (thermal) ignition sources and become flammable at low percent volume mixtures with air. H₂ and NG vapors can both directly explode, but require confinement, a strong (shock wave-causing) initiation source such as an explosive charge, and a fuel/air mixture in the LEL – UEL range for direct detonation. Both fuels can experience DDT depending on the geometry with hydrogen being more susceptible to DDT than methane due in part to its smaller detonation cell size. DDT would be unlikely in the SF-BREEZE application (even in the event of a ventilation failure) because of the lack of confinement on the Top Deck, and the reduced physical dimensions in the Starboard and Port Fuel Cell Rooms that limit “run-up.” LH₂ fires are shorter than LNG fires, and produce significantly less thermal radiation, with the hydrogen fire thermal radiation also strongly absorbed by humidity in the air. Permeability is not a leak issue for hydrogen or LNG piping. Hydrogen embrittlement is surmounted by using 304 and 316 stainless steel components for hydrogen rated hardware. Hydrogen embrittlement does not exist for LNG because methane does not dissociate on the Fe-based surfaces (e.g. stainless steel) of pipelines and conventional storage tanks. In a hypothetical scenario where the entire 1200 kg fuel complement of the SF-BREEZE were released and ignited, the temperature of the Top Deck would still be below room temperature due to the combined effects of cryogenic cooling and hydrogen fire radiant heating. Although an analogous LNG spill would cool the aluminum deck more, the higher radiant flux would heat the deck more, producing a similar final temperature. The results show it is safe to use aluminum for the Top Deck of the SF-BREEZE from the point of view of large fuel pool fires because the Top Deck does not approach 150 °C if the fuel complement were spilled and ignited.

Since LH₂ and LNG are similar in their physical and combustion properties, they pose similar safety risks. For both LH₂ and LNG ships, precautions are needed to avoid fuel leaks, minimize ignition sources, minimize confined spaces, provide ample ventilation for confined spaces, and monitor the enclosed spaces to ensure fuel accumulation < 0.4 % (standard for H₂ monitors) which is far below the fuel/air mix thresholds for any type of combustion.

4 Hydrogen Fueling Infrastructure

It was determined early in the ferry design process that liquid hydrogen will be the on-board fuel for the SF-BREEZE. This chapter describes the technical, economic, and regulatory feasibility of the shore-side facility that will supply LH₂ to the SF-BREEZE.

4.1 Technical Assessment

This section describes the technical requirements, design, operation, and siting of the hydrogen bunkering facility. It also discusses LH₂ availability and supply chain logistics. Performance requirements were determined based on vessel design (from EBDG) and operator requirements (from RWF). Except where noted, information about station design, operation, and LH₂ supply and logistics came from many conversations between the authors and representatives of industrial gas companies (IGCs): Air Liquide [128], Air Products and Chemicals [129], Linde [130], and Praxair [131]. To protect the business interests of these companies, in most cases specific information is only attributed to “the IGCs” which refers to one or more of the companies listed.

In examining the design and performance of the station, the siting, the supply of hydrogen, co-location of hydrogen vehicle fueling, and the passenger interface, all areas were found to be technically feasible to implement today.

4.1.1 Performance Requirements

The ferry is estimated to consume roughly 2,000 kg/day and will be refueled twice per day (Section 3.1.3), once either at the beginning or end of the day and once at midday. Turnaround time for the midday refueling was specified to be a maximum of one hour. Taken together, the system must be able to fill roughly 1,000 kg of LH₂ with the vessel at the dock for less than one hour. Minimizing this turnaround time gives the operator flexibility in scheduling the morning and afternoon rush-hour trip timing. It also leaves some flexibility for locating the bunkering station relative to the passenger embarkation point: if the fueling time can be short, then there is a possibility to site the bunkering facility farther away and accommodating the additional transit time. Considering this, the maximum distance between the bunkering facility and the embarkation point was set to 5 nm by RWF.

To put the refueling requirements in context with current methods, Red and White fleet has their diesel-powered vessels fueled directly from a supply truck (Figure 42). Each vessel takes approximately 1,000 gallons at refuel and the refueling flowrate is 24 gallons/minute for a transfer time of about 40 minutes per vessel. Refueling of all RWF vessels is done at the same time, usually beginning early in the morning, and fueling 3-4 vessels typically takes 4-5 hours including preparations before and after the actual transfer. Another example is the refueling of WETA’s ferries at Vallejo. The *Vallejo* uses around 1,800 gallons of diesel per day and it is filled every evening from a stationary tank onshore. The transfer rate is 90 gallons/minute so the transfer operation lasts about 20 minutes. Along with checklists and procedures to follow before and after refueling, the total duration is about 45 minutes.



Figure 42: Conventional diesel fueling operation at the Red and White Fleet. The diesel truck (left) is transferring fuel through the red hose to the vessels in the background.

One important difference between traditional diesel fueling and hydrogen fueling is that the diesel fueling operation must consider the possibility of spills on the water. The threat of diesel spills means operators must have checklists, training, drills, and maintain spill response kits, all of which add cost to the refueling operation [132]. According to RWF, if diesel is spilled into the water, the resulting fines and cleanup expense can be tens of thousands of dollars for even a few gallons. In contrast, hydrogen is non-toxic and poses no risk of water contamination due to spills or air pollution due to vapors. Gaseous hydrogen leaks will quickly disperse into the air and liquid hydrogen leaks onto water, land, or the vessel will quickly and completely evaporate without any residue. Therefore there is potential for hydrogen refueling operations to be easier, cleaner, and less expensive than traditional fossil-fuel bunkering.

The bunkering facility must comply with all regulations and be designed for safety of operators and the public. Other design considerations are:

1. Limiting the necessary amount of on-site storage.
2. Logistics of delivering hydrogen from off-site via tanker truck.
3. Fill into to the ferry's tank at a specified elevation above sea level.
4. Minimizing the amount of hydrogen vented to the atmosphere.
5. Operate weekdays at full capacity and reduced capacity on weekends.

4.1.2 Design and Function

Figure 43 gives a flow schematic of an LH₂ bunkering facility and associated LH₂ equipment on-board the vessel, developed with input from the IGCs. There are three primary components to the bunkering facility: LH₂ source tank (permanent or trailer-mounted), inert gas supply, and flexible bunkering hose assembly.

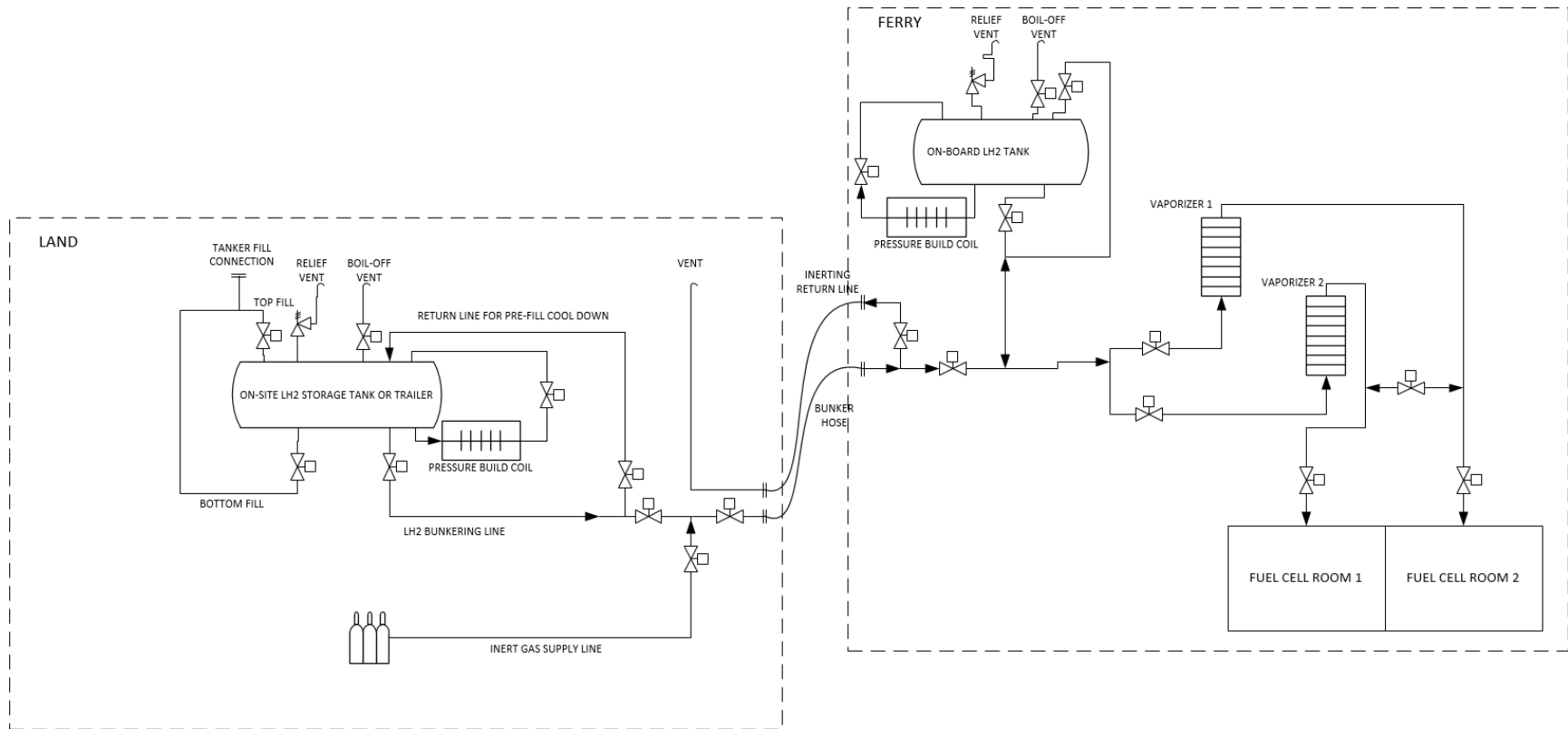

Figure 43: Flow schematic of an LH₂ bunkering facility (left) and, for process clarity, associated on-board LH₂ system (right). Only major components and features are shown.

4.1.2.1 System Operation

EBDG's *Bunkering Procedure* (Appendix A) details the operation of the system. Below are a summary of the steps:

1. Equipment check
2. Precool the shoreside infrastructure
3. Vessel arrival
4. Connect bunkering hose
5. Hose inerting, purging and precooling
6. LH₂ transfer to the vessel tank
7. Removing liquid from the fill hose and inerting
8. Disconnect bunkering hose
9. Vessel departure

The process is similar to LNG bunkering operations. There are a few special considerations for this application. One is the lower boiling point of LH₂ (20 K, -253 C) versus LNG (111 K, -162 C). While equipment and piping has been used for decades that minimizes heat transfer to the fluid, cooling down a warm line or pump will take longer and consume a considerable amount of hydrogen in the process. This has several impacts on the LH₂ bunkering system design. First, LH₂ fill lines should be kept short. In a typical ground-based system, there is a total of 20 ft of line: 5 ft connected to the trailer, 10 ft of flexible hose, and 5 ft connected to the receiving tank (see Figure 44 for an example). Longer fill lines are possible – and there have been LH₂ transfer lines up to 100 ft in length – but typically those would be permanently installed lines.

The second impact is that even with short lines the time needed to cool warm lines and equipment is typically longer than the actual LH₂ transfer, and the total process length is usually longer than the one-hour time limit allotted for the bunkering operation. For example, a 1,000 kg fill process may take 40



Figure 44: LH₂ transfer operation at AC Transit, Emeryville, CA, performed by Linde.

minutes for cooldown, 30 minutes for LH₂ transfer, and 30 minutes for purge and warm-up prior to disconnect. This can be partially managed by precooling the lines and equipment prior to vessel arrival. The IGCs believe a system designed to accomplish a one-hour fill would not be difficult to achieve and is more a matter of implementing the correct control scheme than anything else. On the vessel, it is envisioned that the normal flow of LH₂ from the tank to the vaporizer will pass close by the bunkering fill connection. Thus the amount of piping that needs to be cooled on-board will be minimal.

Transferring the LH₂ from the land tank to the vessel tank can be done quickly. Typical tank transfer times vary today, and the IGCs estimate that the transfer flow rate for bunkering the vessel can be designed high enough to fill 1,000 kg into the tank in 20-40 minutes using either pressure fill (flow by differential pressure of the two tanks) or pump-assisted fill. This kind of “high flow” design includes appropriate sizing of piping and tank nozzles and specification of pressures in the source and receiving tank. Typical tank nozzles are not sized for high flow so it is important to determine the sizes of these nozzles prior to ordering the tanks. While most ground LH₂ tanks commonly have custom designs, this also implies that if filling directly from a trailer, existing road trailers may not have the capability to perform fast transfers and new trailers with the appropriately size plumbing may be required. Appropriate nozzle sizing will not add cost to the tank as long as they are specified prior to build. Summarizing, the requirement for a one-hour fill can be supported from the trailer side with care given to the required LH₂ flow rate that must be supported to achieve the one-hour fill. Refueling of the SF-BREEZE within the one-hour window was therefore deemed straightforward.

4.1.2.2 LH₂ Source Tank

The size and type of the on-site LH₂ storage tank is directly related to the LH₂ production and delivery method. For example, a tank that is sized to supply 2,000 kg/day for the vessel would need to be refilled every day. Most LH₂ delivery trailers carry 3,000 kg to 4,000 kg which means that in this case the trailer would not be able to off-load its entire product that day. This arrangement has little flexibility because it ties vessel operation to LH₂ delivery (if a trailer delivery is delayed or cancelled, the ferry cannot run), and constrains the LH₂ supplier to find other consumers of the LH₂ so as not to return to the terminal with half of a load remaining. In contrast, a tank sized at 10,000 kg could be refilled once every five days, and could receive an entire trailer load at one time. A large tank like this gives maximum flexibility. However, there are factors that could limit the desired amount of LH₂ on-site. 10,000 kg of LH₂ is approximately 37,000 gallons. This would require, for example, at least two standard 16,000 gallon tanks from Chart Industries, each of which is 44 ft long, 10.5 ft high, and 9.5 ft wide, and weighs 47,700 lb. This could be prohibitive based on available space, support structure (especially if on a pier), and the desired “look and feel” if the bunkering facility were to be located in a non-industrial area. In addition, if the total stored quantity of LH₂ is more than 10,000 lb (4535.9 kg) or more (for LH₂ this mass corresponds to about 16,900 gallons), the site must comply with OSHA’s Process Safety Management (PSM) requirements of which the end result is more administrative and operational costs (refer to Section 4.2.3 for details of the OSHA PSM requirement).

If the OSHA PSM threshold is considered as the upper limit of on-site storage, then one 16,000 gallon tank would be sufficient and would hold nearly 4,300 kg of LH₂. This would enable refueling every other day and could receive an entire trailer load of LH₂. It gives some flexibility to the LH₂ supplier so that a

partial LH₂ load could be received by the storage tank on other days if needed. However because of the frequency of filling, it is likely that the LH₂ supplier would need to dedicate two LH₂ trailers for this purpose.

The above scenario involves sending an LH₂ tanker from the liquefaction facility to the bunkering location at least every other day. The amount of on-site storage is not much more than a single LH₂ trailer load. For these reasons it may be simpler to consider no on-site storage tank and filling the vessel directly from the trailer. In this embodiment, the on-site tank would be replaced by a fill piping manifold. An LH₂ trailer could be left at the bunkering facility, hooked up to the fill manifold, and used to fill the vessel directly. When the LH₂ trailer is low, another trailer is parked alongside and connected to the same manifold and LH₂ supply to the ferry can be switched from the empty trailer to the full one. The empty trailer can then be returned to the liquefaction facility to be refilled. The trailer supply logistics are very similar to that of 16,000 gallon on-site tank supply scenario and can actually give more flexibility because the trailers do not need to immediately off-load. In addition, the amount of infrastructure required at the site is minimized which is attractive for both the operator and landowner in case future developments require moving the bunkering location.

Bunkering directly from an LH₂ trailer instead of filling into a large stationary tank first can also reduce the amount of hydrogen vented during filling. When the trailer is filled at the plant, it can be cooled up to 6 K below its boiling point (subcooled). Transferring a cryogenic liquid from one tank to another adds heat to the liquid as it travels through warm components. For a liquid at its boiling point, this immediately results in vaporization and requires venting while for a subcooled liquid this results in a temperature rise of the liquid and it will end up near its boiling point with little or no venting. In a double-transfer process (trailer to tank, tank to vessel) this means that the second transfer will begin with hydrogen at its boiling point and result in vaporized hydrogen and require venting. When considering that the pressure-fill transfer method also requires the receiving tank to be at a lower pressure than the supply tank, the receiving tank will have to be vented down, and/or the supply tank needs to be vented at the end of the fill. Overall this venting can be as much or more than 400kg of vented LH₂ per transfer. As explained in Section 4.1.5, some of this may be able to be captured in a multi-modal fueling station for use in vehicles (that require gaseous hydrogen) but even so losses may be significant.

As indicated in Figure 43, the source tank can be either a trailer or a permanent tank with little changes to the process flows. The disadvantage of this method is the need for capital investment in two LH₂ trailers with sufficient flow capacity to fill the vessel tank in the allotted time. The IGCs were mixed in their preference for on-site storage versus direct fill from the trailer.

One last bunkering option considered does not involve fuel transfer at all. Instead, the tank on the vessel is made to be removed when empty and a full replacement tank is installed. Currently there are DOT-certified ISO container tanks of LH₂ which are made for easy transportation and lifting (see Section 3.1.3.3). These ISO LH₂ containers are based on liquid Helium designs which have very little heat leak and can maintain zero boil-off for weeks. In this scenario, two or more LH₂ ISO containers could be delivered via truck to the bunkering location. A crane on either the vessel or the dock would remove the

empty container from the vessel and load the full one on. The infrastructure is limited to a staging area for the empty and loaded containers and a crane, if needed.

One potential disadvantage of this “swappable tank” method may appear to be the fact that at each tank swap there are multiple connections on the vessel itself that need to be broken and made – that is, the liquid and vapor supply lines to the power plant and perhaps a vent if there is not one built into the ISO tank. The number of connections (two or three) is not significantly different than traditional bunkering but the fact they are on the vessel and subsequently used in normal operation makes it more critical that they are reliable and not prone to repeated failure. In conversations with the IGCs, the kind of connection used for this, a bayonet fitting, is common on all LH₂ delivery trailers today and a single connection point is made and broken used 3-4 times a day, 300 days/year. The lines have gaskets in contact with the liquid and those are replaced only when damage is noted, perhaps two times per year. Some transfer hoses also have O-rings at the seat which are replaced at every transfer. In the decades of experience with LH₂ deliveries, there have not been any observed reliability or lifetime problems with this practice.

While the swappable tank concept is intriguing and technically feasible, it is not considered in any additional detail in this study. If it were to be pursued further some additional issues to consider are:

- Loading/unloading on a pitching or rolling vessel
- Capacity of a single ISO container versus desired time between refueling
- Time required to perform the tank swap
- Suitability of current ISO tank designs to supply LH₂ to the vessel powerplant while in operation. The vessel’s tank is required to maintain a minimum pressure during operation and the tank should be designed to incorporate pressure-building mechanisms and/or anti-slosh baffling to prevent pressure collapse during movement. Current ISO tanks do not include integrated pressure build mechanisms but this could perhaps be built into custom tanks or integrated into the vessel’s LH₂ handling system.
- The act of lifting ISO containers between the dock and vessel adds a different potential hazard whose risk must be characterized and accepted.
- Inclusion of swappable LH₂ tanks into current regulations – currently the IGF Code only considers swappable fuel tanks if they contain LNG.
- Labor required to perform this operation
- Ability to integrate into a multi-modal hydrogen fueling facility (fueling both marine vessels and land vehicles)

4.1.3 Siting and Location

The ferry route used for the basis of this study is between Vallejo and the San Francisco Ferry Building and is described in more detail in Section 3.1.1. One of the requirements of the bunkering facility is that it be within 5 nm of the passenger embarkation point. Figure 45 shows the range of potential shoreline sites within 5 nm of the SF Ferry Building.

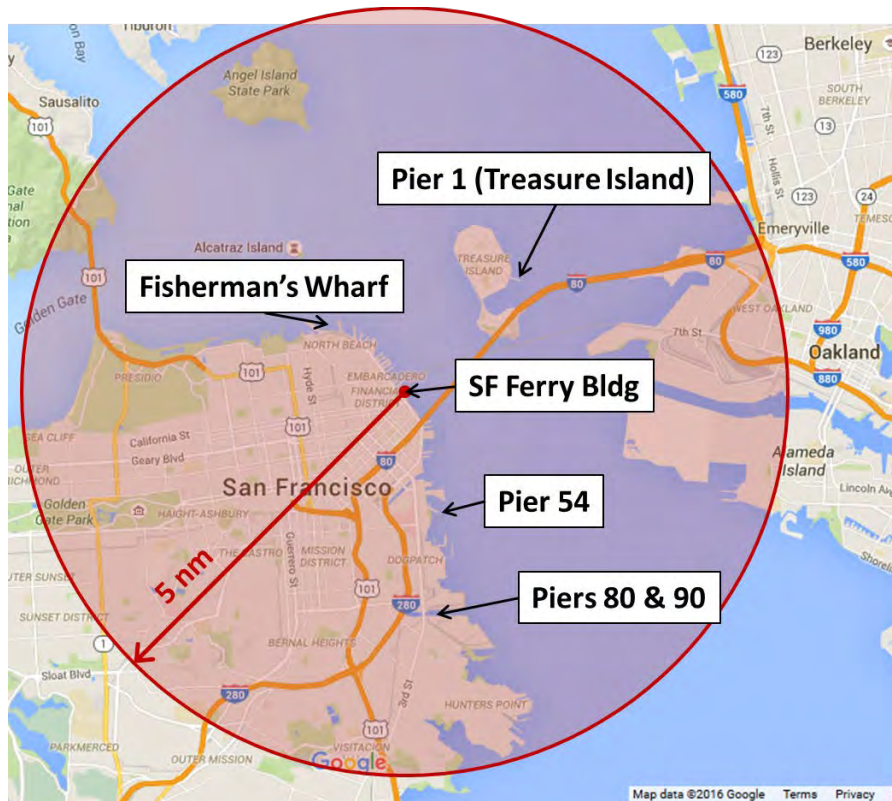

Figure 45: Map of the Bay Area showing a 5 nm radius from the San Francisco Ferry Building and some of the potential bunkering locations evaluated in the study.

In addition to the sites shown in Figure 45, bunkering was considered at the other endpoint of the route, Vallejo, and at the Port of Redwood City. Each site evaluation is described below.

4.1.3.1 Treasure Island – Pier 1

Treasure Island is a man-made island near the center of the San Francisco Bay. Figure 46 shows an overhead close-up of the island. In the southeast corner is Pier 1, a large concrete pier built for use by the US Navy. Treasure Island is in a redevelopment process and its central location in the Bay and large available pier makes it an obvious candidate for consideration as a bunkering facility. Figure 47, designed by Linde, shows a potential layout of the equipment on the pier for both bunkering and hydrogen fueling for fuel cell vehicles.

Treasure Island is central to the San Francisco Bay Ferry system and a bunkering facility there could serve multiple routes [132]. Existing LH₂ trailers have sufficient access to the site to allow convenient refueling. There are no technical issues that would prevent use of Treasure Island Pier 1 for vessel bunkering operations.



Figure 46: Satellite view of Treasure Island. Pier 1 is in the lower right (southeast) corner.

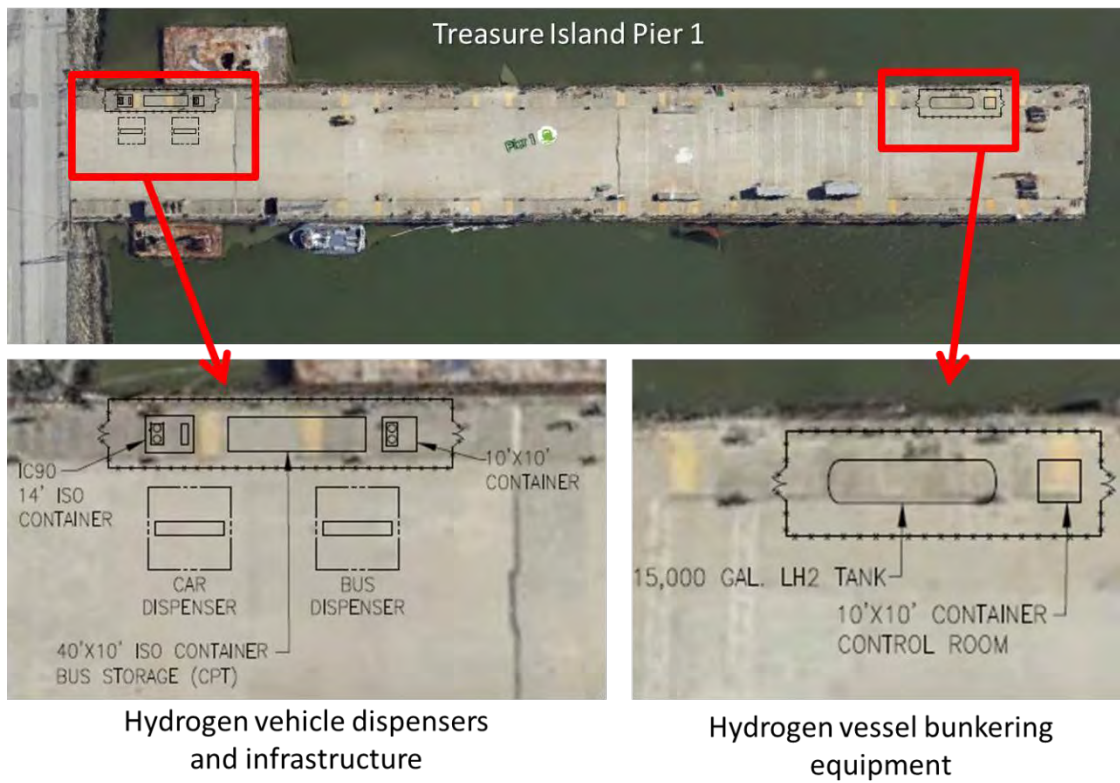

Figure 47: Potential layout of hydrogen infrastructure on Treasure Island Pier 1, including both the equipment for bunkering vessels with LH₂ (right) and that needed for refueling land-based hydrogen vehicles (left). The placement of equipment is flexible; this is just one example. Design and drawings courtesy of Linde.

4.1.3.2 Port of San Francisco

The Port of San Francisco owns and controls most of the waterfront from (referencing Figure 45) west of Fisherman's Wharf to south of Pier 90. Figure 48 shows more details of these boundaries. North of Pier 1, the piers are odd-numbered. South of Pier 1 they are even-numbered. Unless noted otherwise, details in this section come from a combination of site visits and consultations with Port of San Francisco Staff (specific meetings [133, 134] and other conversations).

Before examining specific piers in detail it is helpful to understand some general aspects of siting the bunkering station at any of the piers.

Not all piers have been consistently maintained over the years and some are not able to serve as a vessel dock or equipment host without substantial repair. If repair or development is performed, the amount of water surface area covered or uncovered by the development is reviewed by the BCDC (San Francisco Bay Conservation and Development Commission). Uncovering new water surface area is

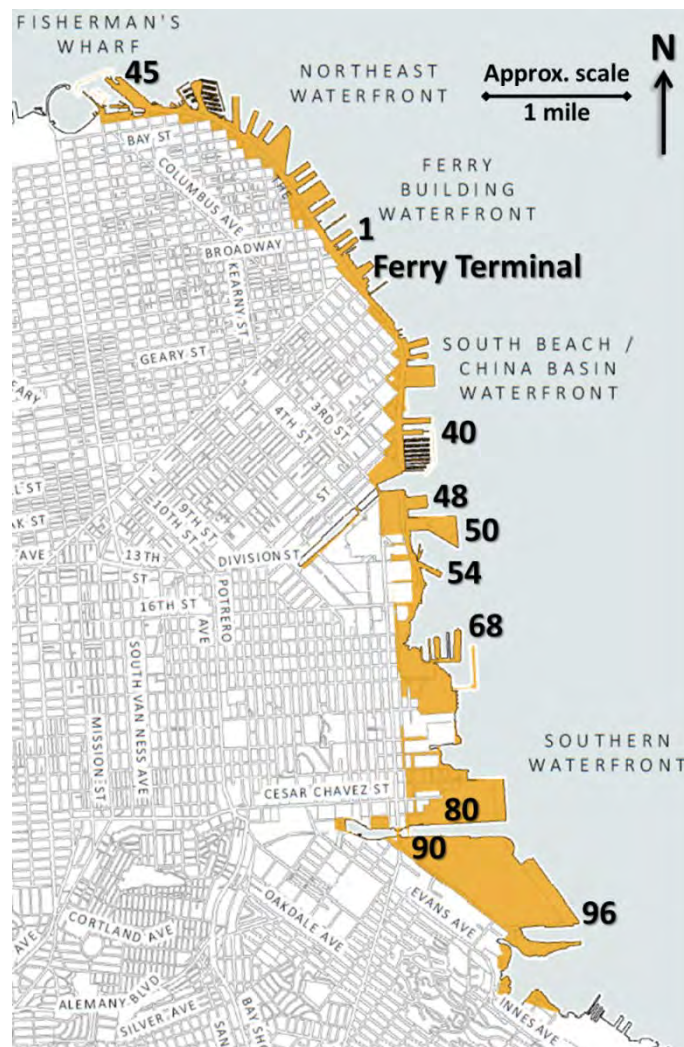

Figure 48: Property owned by the Port of San Francisco (shown in orange shading). Pier numbers relevant to the discussion are overlaid for reference. Map from Ref. [135].

looked upon favorably; conversely covering existing water surface area is not. While there is undeveloped waterfront land within the Port's jurisdiction, development of these lands is a long and complex process due to the sensitive nature of the San Francisco Bay's ecology. Attempting to develop undeveloped land is possible but is estimated to make the project take five-times longer than doing the same project on developed land. Water depth at existing piers must also be considered. The SF-BREEZE ferry needs 10' depth. Dredging of shallow water areas is estimated to take 3-4 years due to necessary permitting.

The bunkering facility owner will lease rather than purchase land from the Port for the project. Unimproved open land leases are currently \$0.30/sqft per month. Improved land such as parking lots which have pavement, curbs, storm drains, etc. are leased for \$0.80-\$1.00/sqft. Apron and open pier space is \$0.32/sqft., and warehouse and building space is higher and depends on the type of structure. Port leases are typically 3-5 years. One implication of this is that a pier with a current tenant may become vacant shortly (however, a tenant who refuses to leave could lengthen the process). However, some areas of the Port are currently in a long-term redevelopment process. Any land that has a redevelopment plan already in place must be excluded from consideration unless the proposed development happens to be able to accommodate the new proposed project.

What follows is examination of specific locations in the Port.

4.1.3.2.1 Pier 40 and All Piers North

In general the piers from 40 to the north have more tenants, more demand, a lower vacancy rate, less open space, and are more public than the piers to the south. While this is attractive from a ferry commercial point of view, it makes siting any kind of industrial-looking facility on the waterfront very difficult if not impossible. There have been several ultimately unsuccessful developments on piers in this area that serve as examples of what can be expected as a likely outcome for any proposed bunkering facility. Excluding these piers as options, the search for a suitable location can begin at Pier 48 and continue south.

4.1.3.2.2 Pier 48

Pier 48 is part of a long term redevelopment plan and is controlled by the MLB's San Francisco Giants baseball club. It is not available.

4.1.3.2.3 Pier 50

Pier 50's north side is under lease to West Star and unavailable. The east end has deep water (>40') but is used by MARAD's ready reserve fleet. The bulkhead end of the pier may not be strong enough to support equipment weight. Thus, Pier 50 was deemed not viable.

4.1.3.2.4 Pier 54

Pier 54 (Figure 49) is leased short-term and does not have any existing development plans. It has significant amount of Port-owned land at its base, which is currently being used as a parking lot. The area where it is located tends to be business/light industrial dominant. However, there are two aspects of Pier 54 that need to be considered. The south side is exposed to very rough swells during storms so the ideal location for the bunkering is at the northwest corner, indicated in Figure 49. In addition, a

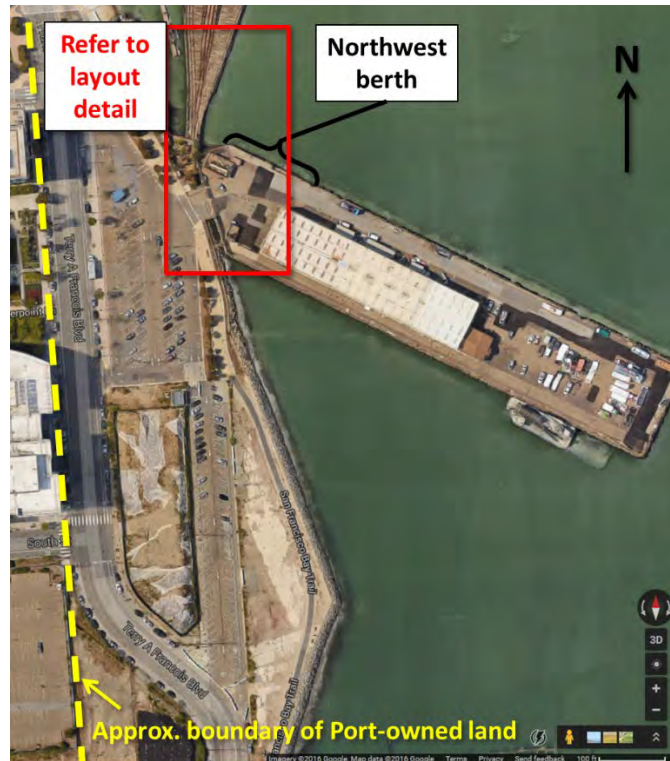

Figure 49: Satellite view of San Francisco Pier 54. A potential facility layout detail (red outline) is shown in Figure 51. The dashed yellow line indicates the approximate boundary of Port-owned land.

structural assessment performed by the Port in 2013 revealed deterioration of some piles and other concrete support members [136]. As a result the pier was classified as Restricted Use and there is currently a 10-ton (gross) limit on vehicle traffic. This means that either (a) repairs are needed if the pier is to support the weight of significant infrastructure, for example an LH₂ storage tank, or (b) any such equipment needs to be located on the adjacent land and piping extended to the bunkering spot.

Pier 54 is located in an area with significant potential for growth. Figure 50 is an artistic rendering of the planned development in the area, highlighted with the addition of the Chase Center, a new arena that would become home to the NBA’s Golden State Warriors basketball team. The area is currently home to the UC San Francisco Medical Center and both the City and the Port expect significant development in the coming years. As part of this plan, the City is considering addition of a ferry landing at 16th Street in an effort to improve mass transit serving the area. If this occurs, this could be used as an embarkation point for the SF-BREEZE ferry in addition to or instead of a landing at the Ferry Building. The site also has excellent freeway access, which is an important requirement for fuel cell electric vehicles needing to refuel at the vehicle refueling part of the multi-modal (vehicles, vessels) hydrogen complex.

Pier 54 is an attractive option. The Port has determined that it is a feasible and preferred location for a hydrogen bunkering operation provided the berthing and structural limitations can be overcome. Figure 51 shows an example layout of hydrogen equipment needed for both the ferry and vehicle fueling operations.



Figure 50: Pier 54 location and surrounding area. Background photo from Ref. [137]



Figure 51: Example layout of hydrogen equipment at Pier 54's northwest berth supporting a vehicle fueling station and direct truck-to-vessel LH₂ bunkering. For orientation see inset on Figure 49. Layout courtesy of Linde.

4.1.3.2.5 Piers 64-70

Piers 64-70 are too dilapidated for current use and there are redevelopment plans in place. They are not available.

4.1.3.2.6 Portrero Power Plant Site

The Portrero Hill power plant (decommissioned) is located between Piers 70 and 80. The land is currently being redeveloped and potentially available. However, the east (water's) edge of the property is exposed making berthing difficult in poor weather, the water depth is too shallow for the SF-BREEZE ferry (about 5 ft), and the soil at the water's edge is potentially contaminated. Therefore this site was deemed not suitable.

4.1.3.2.7 Pier 80

Pier 80 is a technically acceptable location, but as of the time of this writing is being leased to a priority tenant and cannot be considered for a bunkering location. The evaluation that follows is still included in case the situation changes in the future.

Pier 80 (see Figure 52) hosts the last cargo operations at the Port. The north, east and southeast berths are in a secure perimeter and not available. A potential berth is on the north side of Pier 80 near Warm Water Cove. However this area does not currently have a dock and the development of that could be difficult. It is not likely suitable for passengers and access is convoluted.

The berth at the southwest corner ("A" berth) on the Islais Creek Channel, closest to the Illinois St. bridge, is outside the secure perimeter and cargo operations and is a technically viable spot for the ferry to dock. There is also a large parking lot on the land next to this location which could be used for

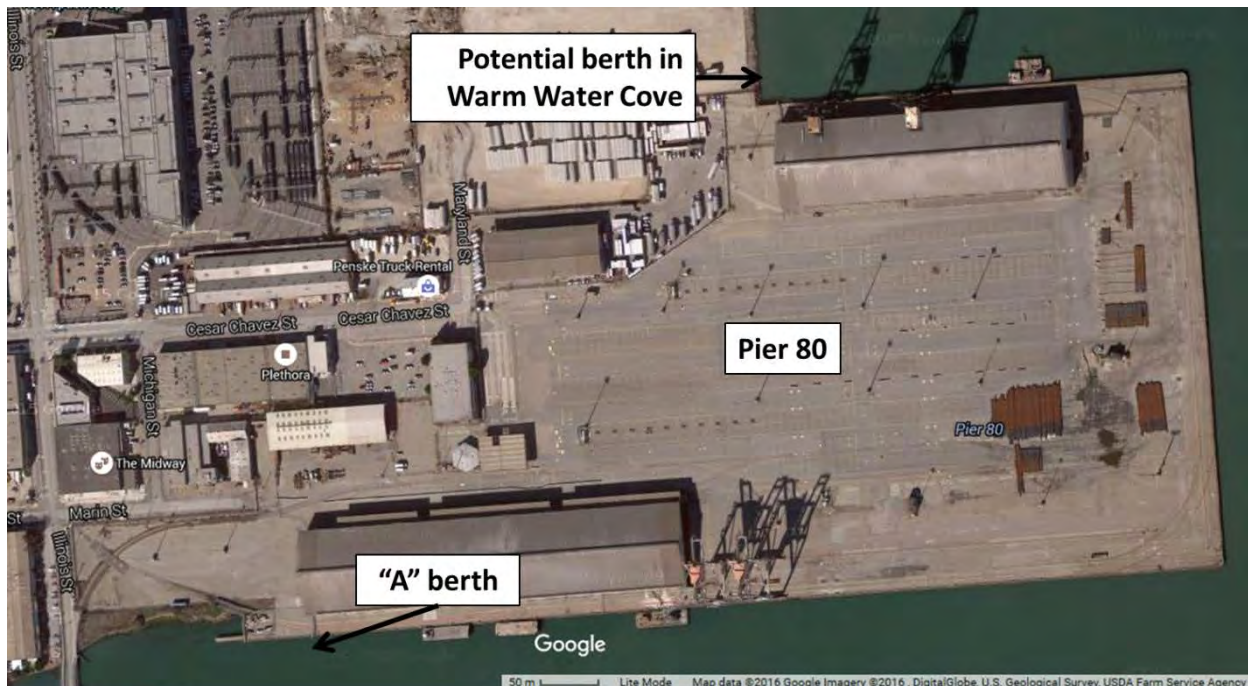

Figure 52: Satellite view of Pier 80, San Francisco CA.

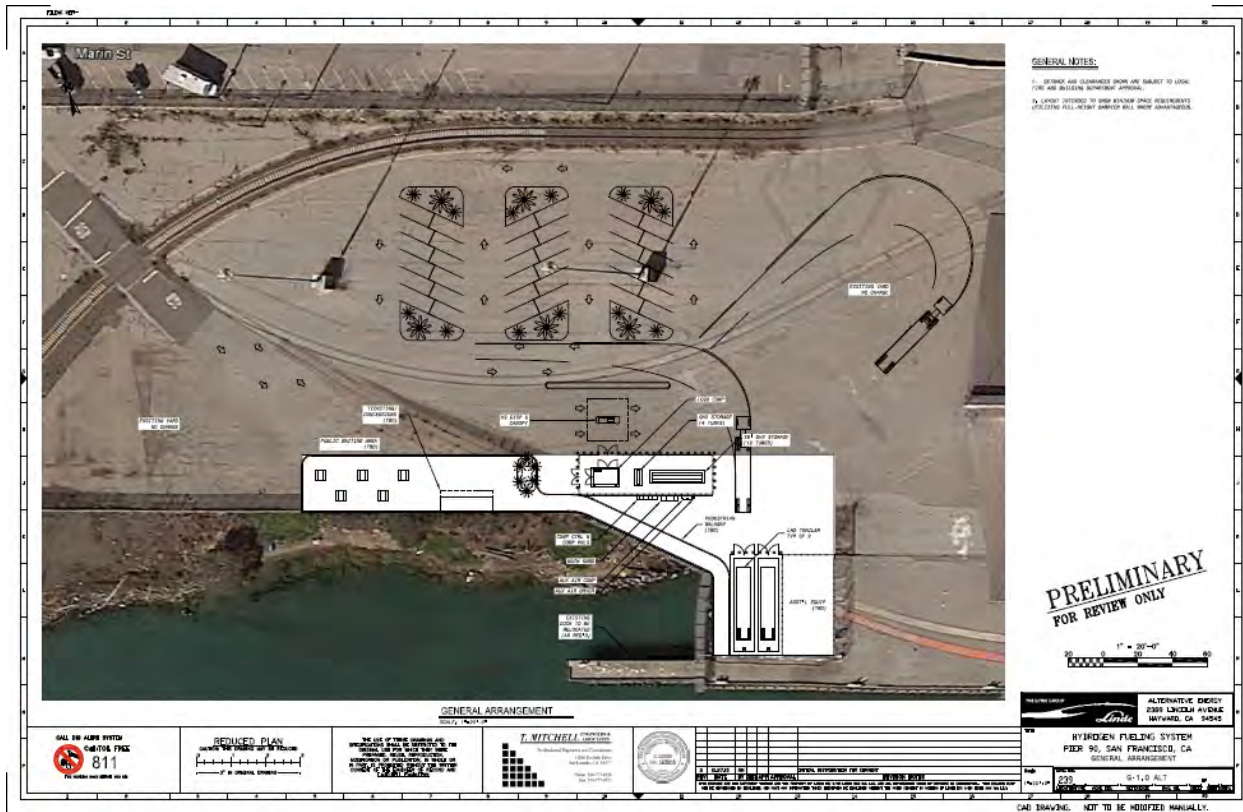

Figure 53: Example layout of hydrogen infrastructure at Pier 80. The vessel at “A” berth would be at the bottom right. This layout assumes bunkering directly from an LH₂ trailer into the vessel. It also includes equipment needed for refueling land-based hydrogen vehicles and parking for passengers. Design and drawing courtesy of Linde.

parking or partially converted to house bunkering equipment. Access to/from this parking lot is convenient for passengers or hydrogen vehicle drivers. There is existing electrical service in the vicinity that is sufficient for fueling equipment. Figure 53 shows an example layout at this location of equipment for vessel bunkering as well as hydrogen vehicle fueling.

4.1.3.2.8 Pier 90

Pier 90 (Figure 54) is across the Islais Creek Channel from Pier 80. The Port uses it for maintenance staging and laydown as it is currently the only place in the Port where maintenance equipment and materials can go from water to land. This makes it currently unavailable but, like Pier 80, the evaluation is included here for future reference. The SF Fire Department also berths their boats here to fill at the fire water connections. The water depth in the Islais Creek Channel is sufficient for vessel traffic and the channel is wide enough for maneuvering.

The approximately 75 ft closest to water is pier on pilings and is mostly not structurally sound, although there is a portion that has been made acceptable to use, even with heavy equipment. These areas are indicated in Figure 54. However, to avoid interrupting the maintenance activities it would be preferred to utilize the east half of the pier. In this case, the pier on pilings portion is so dilapidated the best course of action would likely be to demolish this part and install a gangway and float for berthing. Demolition of 100 ft of pier is estimated to cost \$300,000 per 100 ft of pier, or in this case about

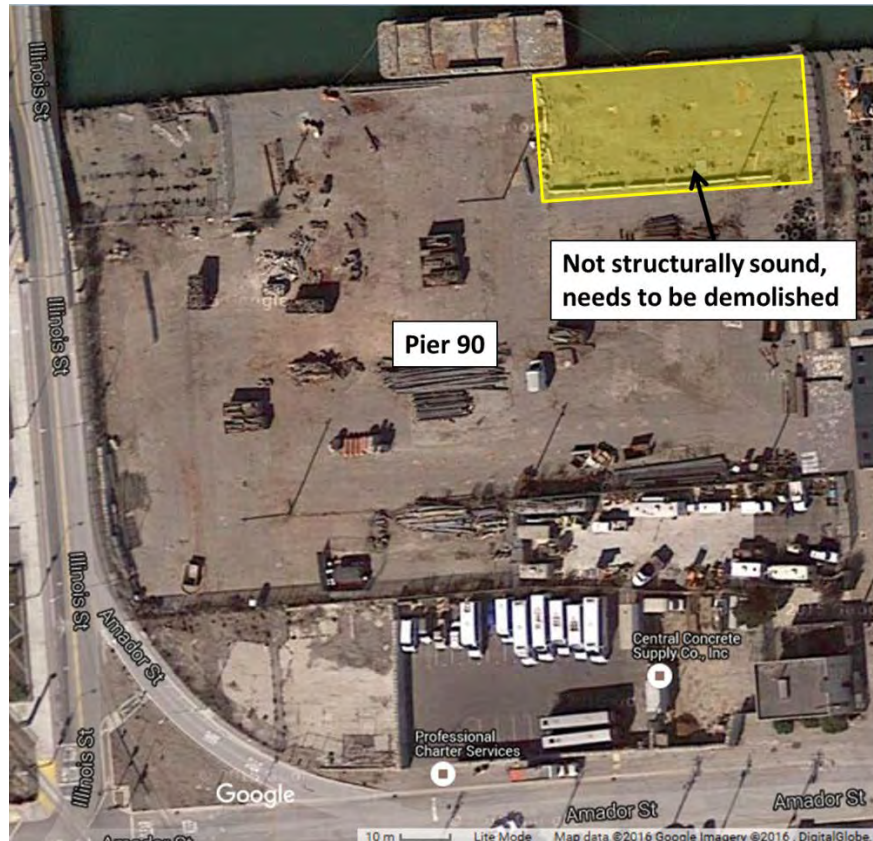

Figure 54: Satellite view of Pier 90.

\$450,000 to \$600,000 for the 150-200 ft required. This would uncover more water surface area which is favorable as mentioned in Section 4.1.3.2. By contrast, demolishing and completely rebuilding the entire 450 ft pier is estimated to cost \$5 million with no change in surface area coverage.

It is uncertain whether the current electrical service to Pier 90 is sufficient for the fueling operation. A vehicle hydrogen fueling station typically needs service rated for 600 A at 480 V. Additionally, despite the large amount of area at Pier 90 which could accommodate a passenger parking area, passenger vehicle access, which is from the south, is hindered by the high level of truck traffic on Amador St. due to the cement facilities at Pier 92 and the complex 3-way intersection at Amador, Illinois, and Cargo Way. Additional features of Pier 90 are that it is likely to have natural gas service because of the pipeline going to Pier 92, which may be useful if on-site generation of hydrogen is explored, and the site is across Illinois St. from San Francisco Fire Department Station 25 which may help with acceptance of this unique facility. Finally, it is close to a USPS distribution center which could eventually leverage the vehicle fueling capability if USPS fleet vehicles become zero emission hydrogen vehicles. (However, it is equally likely that in that case the USPS would establish an on-site refueling facility.)

While Pier 90 is not currently available to host the bunkering facility, it can technically fulfill the requirements for SF-BREEZE bunkering. Figure 55 shows an example layout of how a combination bunkering and vehicle fueling facility could be constructed at Pier 90.

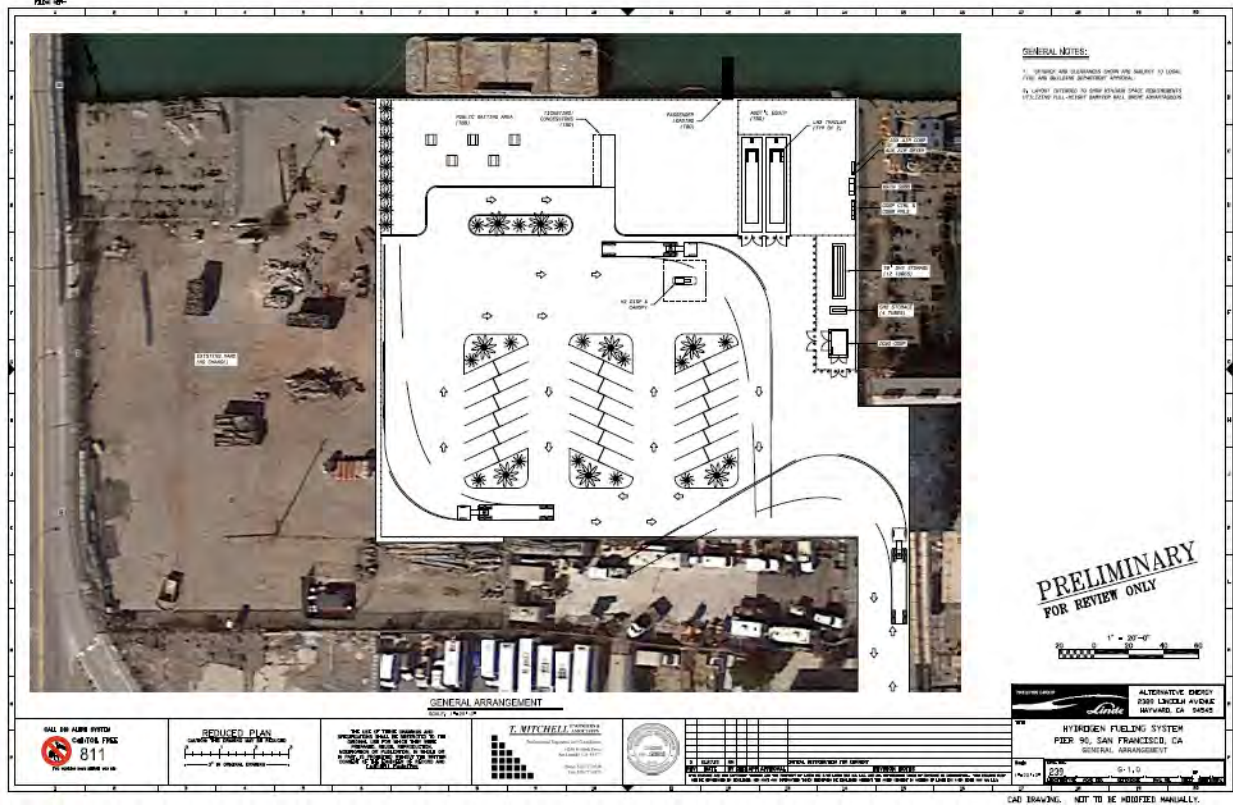

Figure 55: Example layout of hydrogen infrastructure at Pier 90. In this embodiment, the dilapidated section of the pier is replaced. The vessel berth is at the top right. This layout assumes bunkering directly from an LH₂ trailer into the vessel. It also includes equipment needed for refueling land-based hydrogen vehicles and parking for passengers. Design and drawing courtesy of Linde.

4.1.3.2.9 Piers 92 and 94

Pier 92 is occupied by cement, concrete, and rendering facilities and is not available. Pier 94 is occupied by a sand and aggregate company and is not available. Between Pier 92 and 94 is open space but it is natural wetlands and likely infeasible to develop.

4.1.3.2.10 Pier 96

Pier 96 (Figure 56) was a container terminal until 1998. Now it is used for sand and aggregate shipping, and Recology has a recycling facility on the south side. The large open area of the pier is frequently used by the San Francisco Police Department as a driver training course (Figure 57). The pier is structurally sound and should be able to support the weight of any fueling equipment or truck deliveries.

The eastern berths are too exposed to waves and swells and would be hazardous for a lightweight ferry. The south berths along the Lightering Basin are protected, but the water depth is only 4-5 ft and would likely need to be dredged. The southwest berth can be made available and has a large amount of space that can easily accommodate bunkering equipment and storage tanks. However, the location of Pier 96 itself is not in a convenient for passenger vehicle refueling. The access road from the pier entrance to the southwest berth is in very poor condition with a lot of truck traffic, and the area around the

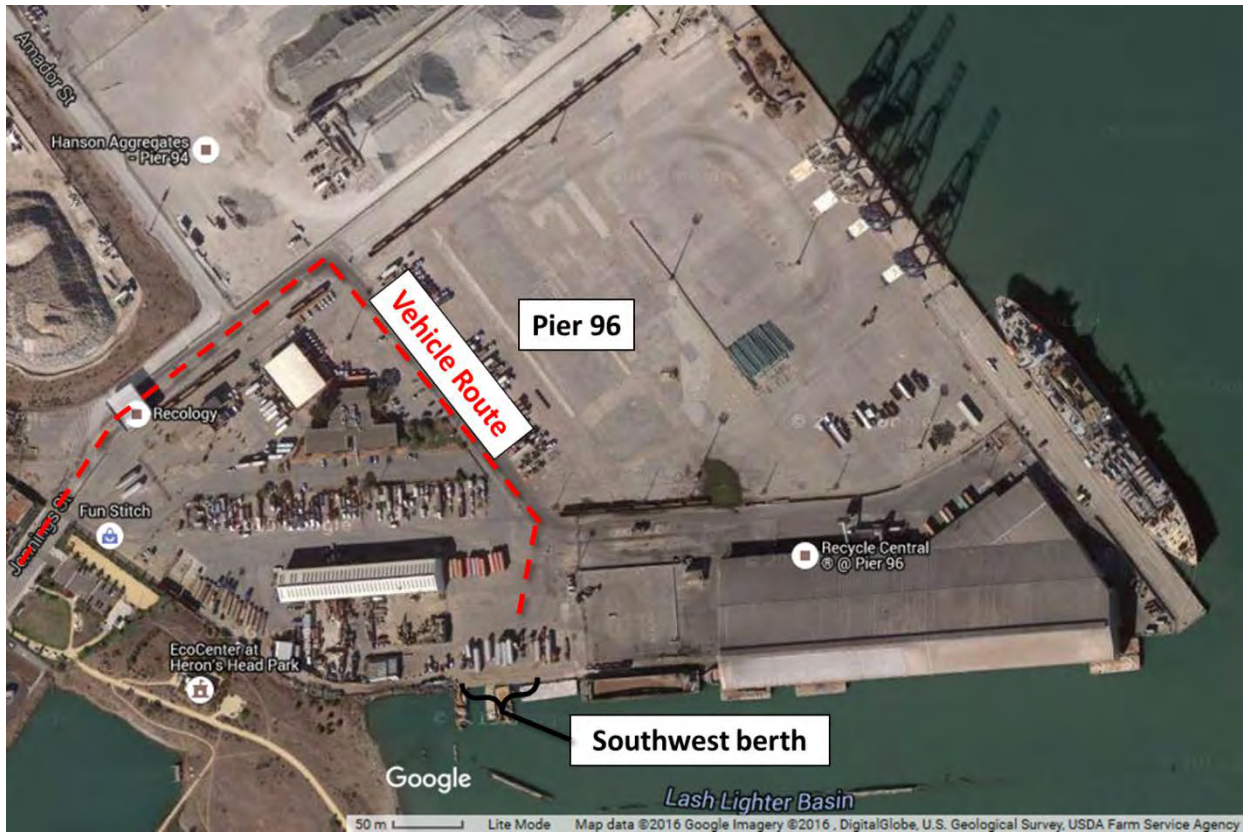

Figure 56: Satellite view of Pier 96 showing location of the southwest berth and the vehicle route (red dashed line).



Figure 57: The open area of Pier 96 hosts the City of San Francisco Police Department's driver training course.

southwest berth does not engender a sense of security for public refueling of personal hydrogen vehicles.

In summary, Pier 96 is a technical feasible and available candidate for vessel bunkering with enough space to allow expansion for multiple vessels, provided the Lightering Basin can be dredged as required. However, it is not a viable candidate for co-location of a private vehicle fueling station due to its location and setting.

4.1.3.2.11 South of Pier 96

While the port owns additional land south of Pier 96 around India Basin, it is primarily undeveloped shoreline and cannot be developed. In addition, India Basin itself is too shallow and would require significant dredging. Therefore there are no feasible Port of San Francisco bunkering or embarkation locations south of Pier 96.

4.1.3.3 Vallejo

The ferry landing at Vallejo (Figure 58) is the other endpoint of the SF-BREEZE's notional route. Currently, the San Francisco Bay Ferry ferry that services this route bunkers at San Francisco Bay Ferry's Mare Island facility which is across the Mare Island Strait from the passenger terminal. There is sufficient space for an LH₂ bunkering facility next to the San Francisco Bay Ferry facility. However, the location is not feasible for a co-located hydrogen vehicle refueling station because it is an inconvenient location for vehicle drivers.

On the other side of the Mare Island Strait is the passenger loading point (Figure 59). This location would likely be difficult to site a bunkering facility due to public exposure and space constraints.

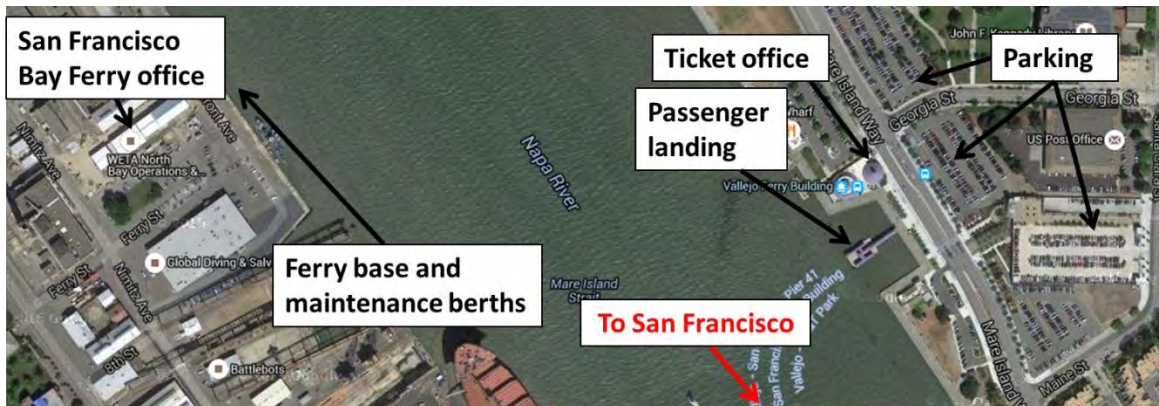

Figure 58: Layout of the existing Vallejo ferry terminal (right side of the Mare Island Strait) and San Francisco Bay Ferry's ferry base (left side).



Figure 59: Passenger ferry dock at Vallejo. The ticket office and lobby is in the building in the far right background.

4.1.3.4 Port of Redwood City

The Port of Redwood City is in the South San Francisco Bay and not within 5 nm of the evaluated route of the SF-BREEZE. It is, however, another possible destination for the ferry instead of or in addition to Vallejo. It is nearly the same distance from the SF Ferry Building to the Port of Redwood City as it is from the SF Ferry Building to Vallejo, so one destination could be substituted for the other and the ferry specifications and performance remain the same. The Port of Redwood City is an attractive destination because it is a marine gateway to a center of high-tech companies at the west edge of Silicon Valley. Industry giants such as Google, Apple, Facebook, Oracle, Hewlett Packard, as well as countless smaller companies have corporate campuses in this area with thousands of commuters travelling on private busses between Silicon Valley and San Francisco each day [138, 139]. A high-speed ferry from San Francisco to the Port of Redwood City could be an attractive alternative.

The Port of Redwood City is a deepwater port that imports construction materials such as cement, aggregate, bauxite, and gypsum, and exports shredded scrap steel from vehicle recycling. It is in an industrial area but also hosts commercial businesses and, in its marina section, retail. There are five large wharfs (see Figure 60). Wharfs 1 and 2 are heavily used for material imports and are not available. Wharf 3 and surrounding area is used for vehicle scrap metal processing and exporting. The south/west end of Wharf 4 could be available, but access is difficult. The best location would be Wharf 5, which is sometimes used for cargo at its north/east end but largely available and is also a large open, structurally-sound pier. It is the closest to the marina/retail part of the port.

Wharf 5 is 60 feet wide, and access is excellent - an LH₂ trailer could come in one side and drive out the other (Figure 61). Wharf 5 has security already in place (fences), electricity, and has about 75 feet of space between the dock and the land which aids in meeting the setback distances required for siting hydrogen storage systems. There is also the possibility of creating a parking lot near Wharf 5 as shown in Figure 62. It is close to the major freeway, CA-101, and has convenient vehicle access for both passengers and hydrogen vehicle drivers. It is the closest wharf to the marina/retail part of the port and



Figure 60: Port of Redwood City map showing the five wharfs.



Figure 61: View on Wharf 5 looking south/west. The pier is well maintained, wide, structurally sound, and available.

is well-kept so public access can be comfortable. Therefore, the Port of Redwood City, Wharf 5, is a feasible location for a multi-use hydrogen fueling station and is strongly supported by the Port staff.

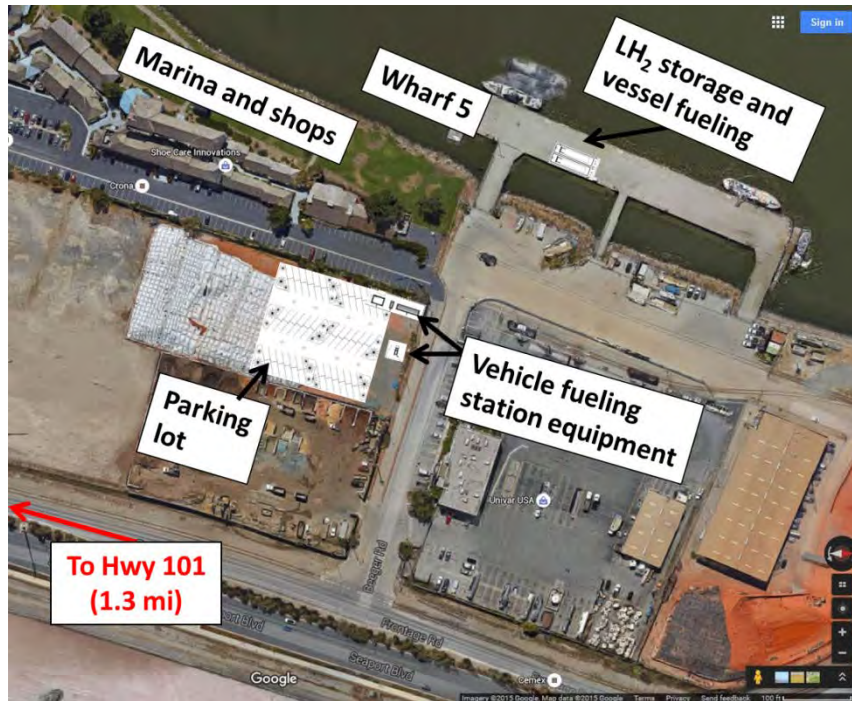

Figure 62: Example layout of hydrogen equipment at Wharf 5 at the Port of Redwood City. This layout assumes bunkering directly from an LH₂ trailer into the vessel. It also includes equipment needed for refueling land-based hydrogen vehicles and parking for passengers. Layout by author, based on equipment needs and dimensions from Linde.

4.1.4 Hydrogen Supply

The SF-BREEZE ferry will consume about 2,000 kg (2 metric tons) of liquid hydrogen each day. In addition, an accompanying vehicle fueling station will likely consume 200-400 kg/day when fully utilized, but could be as little as 1/10th that in the beginning years of the project [140]. Thus total hydrogen consumption can be safely bounded by 2,500 kg/day (2.5 metric tons/day) at the upper end if just a single SF-BREEZE ferry is utilized. Since typical vehicular hydrogen fueling stations being installed today average less than 200 kg/day, it is fair to question the availability of supporting a use that is more than 10-times as large.

Fortunately, there is a very large hydrogen generation industry in the U.S. which primarily serves the petroleum refining and petrochemical production industries. In 2006, the total hydrogen generation capacity in the United States was 10,683,000 metric tons per year, or 29,268 metric tons/day [141]. The facilities are across the country and there are several major gas suppliers who have extensive distribution networks to deliver hydrogen to the use destination.

Hydrogen is produced by steam reforming of methane (SMR) and electrolysis (splitting water into hydrogen and oxygen). There are other methods to produce hydrogen [142] but these are the two primary ones.

The methods to produce *renewable* hydrogen differ between the two pathways. For electrolysis, this just means sourcing renewable electricity. This can be done directly, for example by connecting the electrolyzer to a solar or wind farm, or indirectly, for example by connecting at any point on a utility grid

and purchasing renewable electricity through the utility company. For SMR, renewable hydrogen can be produced from renewable methane, often called biogas. An SMR can be directly connected to a source of biogas, such as situated at a landfill or wastewater treatment plant, or it can be connected anywhere on the natural gas grid and, similar to electricity, a purchase agreement with a remote biogas producer can be arranged where the producer remotely injects biogas into the gas grid.

Both renewable electricity and renewable methane are available in quantities needed for the SF-BREEZE. Ref [143] estimates there is potential to produce 4,500 metric tons/day of hydrogen from existing biogas resources distributed across the US. One IGC surveyed noted that securing the amount of biogas needed for the quantity of hydrogen needed for the SF-BREEZE was a matter of having a contract in place and was not limited by available supply. Another IGC noted that the quantity required for the SF-BREEZE actually makes it easier to secure biogas to produce renewable hydrogen compared to the small quantities of renewable hydrogen needed for today's hydrogen vehicle-only refueling stations.

While there is clearly an adequate supply of hydrogen for the SF-BREEZE, one complication is the fact that the SF-BREEZE requires liquid hydrogen. While there is roughly 30,000 metric tons/day of total hydrogen generated in the US, in 2009 the amount of *liquid* hydrogen generated is much smaller, estimated to be 214 metric tons/day in the US. Of this, 110 is generated by Praxair and 104 from Air Products. Plants in Canada generate an additional 81 metric tons/day, of which 30 comes from Air Products, 29 from BOC, and 22 from Air Liquide [144].

Still, the amount of LH₂ required for the SF-BREEZE is very small relative to the total North American capacity. Putting this amount into perspective, NASA's space shuttle required approximately 160 metric tons of LH₂ each launch. This is equivalent to 54 truckloads [126] (assuming one truckload carries approximately 3,000 kg). In the case of delayed or aborted launches, 8 additional LH₂ trucks were needed within a day [129]. The LH₂ generation and distribution infrastructure in the US was designed to handle this demand and logistical challenge and remains operational today. There are regional plants spread out around North America and the trucking infrastructure is large and robust. All-in-all, the LH₂ supply and distribution system existing in the US is not a technical obstacle to implementation of the SF-BREEZE. Both domestic LH₂ suppliers expressed confidence in the ability to generate and deliver the required amount of LH₂ (including renewable LH₂).

4.1.4.1 On-site Generation of Liquid Hydrogen

Although there is a robust LH₂ supply and distribution network, the capacity of the largest LH₂ trailer is 4,000 kg. This means that there would be, on average, one delivery truck every two days of operation of the SF-BREEZE. Delivery of LH₂ is more efficient on a per-kilogram basis than delivery of gaseous hydrogen (where a typical trailer carries 230 kg), but the project team also considered the alternative of on-site generation to completely eliminate transportation logistics and cost.

SMR is a thermal process that has higher efficiency at larger scales. This means that small SMR plants are less efficient and the resulting hydrogen is more expensive on a per-kg basis. Electrolysis does not exhibit appreciable economies of scale; the cost difference of produced hydrogen is more dependent on

the source of electricity than the size of the plant [145]. Both options are technically feasible at the scale required for the SF-BREEZE (2,500 kg/day).

One complicating factor in the SF-BREEZE's case is the fact that the ferry requires liquid hydrogen. Liquefaction is an energy-intensive process and has strong economies of scale. While technically possible at any scale, surveyed IGCs indicated the lower capacity limit of a commercially-viable liquefaction plant is 5-10 metric tons/day. In other words, on-site liquefaction could be considered for a fleet of 3-5 SF-BREEZE ferries but would not make sense for a single ferry.

Therefore, while technically possible to generate renewable or fossil-based liquid hydrogen on-site, because of the anticipated high costs of on-site generation due to the relatively small usage, the chosen path forward is off-site generation and transportation to the bunkering facility.

4.1.5 Co-location with Hydrogen Vehicle Fueling

Having a facility dedicated to vessel-only fueling has been shown to be technically viable and is sufficient to meet the needs of the SF-BREEZE. However, there are synergistic advantages to a facility that can fuel land-based vehicles as well. One distinguishing feature that helps to drive some of these benefits is that vehicular hydrogen stations (Figure 63) do not dispense LH₂ to the vehicles. Rather, they dispense high pressure gas at either 350 bar (5,000 psi) for trucks and buses, or 700 bar (10,000 psi) for passenger cars. Some of these advantages are described in this section.

4.1.5.1 Benefits to the Vessel

During the bunkering process there is some amount of LH₂ that is vaporized during the cool-down process. This hydrogen may not be able to be used to fill into the vessel tank. While there are control schemes that may be able to recycle and re-condense the gaseous hydrogen, it would be easier to vent



Figure 63: Hydrogen vehicle fueling station in Torrance, CA.

to the atmosphere. While this poses no environmental hazard, it does result in wasted hydrogen. An alternative is to capture this gaseous hydrogen and use it for vehicle refueling. This can be done in a simple manner by having a small low pressure storage tank to capture the excess gaseous hydrogen which can feed into the vehicle station's compression system to be stored at high pressure until needed for vehicles.

4.1.5.2 Benefits for the Vehicles

The cost of hydrogen for vehicles is currently very high, about \$14/gge. This is due to the high cost of hydrogen fueling station equipment combined with the low utilization (lower than 10%) in the early days of hydrogen vehicle adoption. (Utilization is the ratio of actual station throughput to designed throughput.) In cases of low utilization, the station owner must increase the per-unit price of hydrogen to recover the investment cost. The station owner also has a significant amount of investment risk in the early days of hydrogen vehicle adoption because there is little certainty in the number of hydrogen vehicles that will (a) be adopted by the public and (b) use a given station.

In contrast to the situation with vehicles, a vessel like the SF-BREEZE provides a large, consistent quantity of usage from the outset. A multi-modal hydrogen refueling complex sized for 2,000 kg/day for the ferry and 500 kg/day for vehicles can safely assume usage of 2,000 kg/day, or 80% utilization, even if no vehicles develop. In this sense, the station owner is using the vessel consumption to de-risk the development of a vehicle refueling station while maintaining the benefit should vehicle consumption develop as hoped. The end result is lower-cost hydrogen for the vehicles.

Interestingly, the IGCs were mixed in their opinion on whether the high throughput of the station could bring down the cost of hydrogen by itself by leveraging the high volume for discounted prices of the delivered product. In other words, the idea that having a consumption of 10,000 kg/week would cost less on a per-kg basis than a consumption of, say, 100 kg/week. One supplier said it could be 10%-20% cheaper for the large consumption only due to the fact that the small consumer would likely be using delivered gaseous hydrogen, which is cheaper to make but more expensive to transport than liquid hydrogen. Another supplier noted that all of their deliveries to an area go through a distribution center where liquid is trucked in from out of the area and local deliveries make a small part of the transportation cost. In this case, there is no advantage to supplying liquid to the ferry and no economy of scale. All-in-all, whether this volume difference can make a difference in the cost of the delivered hydrogen highly depends on the logistics of the supplier.

According to one IGC an exception to this is the case of renewable hydrogen. For renewable hydrogen, the volume required by the vessel makes it easier to procure than the small volumes needed for vehicle-only stations. This translates directly to lower cost for renewable hydrogen for both the vessel and the vehicles in the case of a multi-modal hydrogen refueling complex and is a clear benefit to hydrogen vehicles that would not exist without the vessel. This is a dramatic impact the SF-BREEZE vessel would have on GHG emissions nationally.

4.1.6 Passenger Embarkation

The SF-BREEZE ferry is designed to accommodate passengers in every way similar to existing ferries. This means that current methods of passenger embarkation remain the same. The exact method will depend on the site chosen. The easiest method is installation of a floating dock which can extend from any existing available land as shown in use at Vallejo in Figure 59. If docking at an existing pier, a simple ramp to match the level of the entry door is all that is needed.

One issue related to passenger embarkation is the issue of doing so at the same time that refueling operations are being conducted, a practice known as simultaneous operations, or “sim-ops”. This could be advantageous in cases where turnaround time is very important and cannot be met if both operations happen independently. This is not necessarily a specific issue to the SF-BREEZE; for example, WETA is not allowed to perform sim-ops with their diesel powered ferries at their Vallejo refueling point. Because it is not logistically necessary to perform sim-ops with the SF-BREEZE this issue was not addressed in the study.

4.2 Regulatory Assessment

There are no existing regulations or rules that completely cover hydrogen bunkering but there are related regulations and guidance that, when combined with technical knowledge of hydrogen properties and systems, can be used to help define a regulatory approach for LH₂ bunkering and develop future regulations. The existing documentation includes:

1. US Code of Federal Regulations (CFR)
 - a. Title 29 Part 1910.119: Process safety management of highly hazardous chemicals [OSHA’s Process Safety Management (PSM)]
 - b. Title 33 Part 127: Waterfront facilities handling liquefied natural gas and liquefied hazardous gas
2. USCG
 - a. Navigation and Vessel Inspection Circular (NVIC) No. 01-2011: Guidance related to waterfront liquefied natural gas (LNG) facilities (January 24, 2011)
 - b. CG-OES Policy Letter 01-15: Guidelines for liquefied natural gas fuel transfer operations and training of personnel on vessels using natural gas as fuel (February 19, 2015).
 - c. CG-OES Policy Letter 02-15: Guidance related to vessels and waterfront facilities conducting liquefied natural gas (LNG) marine fuel transfer (bunkering) operations (February 19, 2015).
 - d. LGC NCOE Field Notice 01-2015, CH-1: CH-1 to LNG Bunkering Recommendations (January 5, 2016).
3. ABS
 - a. LNG Bunkering: Technical and Operational Advisory
 - b. Bunkering of Liquefied Natural Gas-fueled Marine Vessels in North America
4. DNV-GL
 - a. DNVGL-RP-G105: Development and operation of liquefied natural gas bunkering facilities (October, 2015).
5. ISO

- a. International Standard ISO/TS 16901: Guidance on performing risk assessment in the design of onshore LNG installations including the ship/shore interface (2013)
- b. Technical Specification ISO/TS 18683: Guidelines for systems and installations for supply of LNG as fuel to ships (2015)
- c. Technical Specification ISO/DIS 20519: Ships and marine technology - Vessel - LNG bunkering standard (December, 2015)

The ABS and DNV-GL documents are excellent resources for understanding the sum of all of these existing regulatory parts. In particular, ABS' Bunkering of Liquefied Natural Gas-fueled Marine Vessels in North America presents useful summaries of existing regulations applicable to the SF-BREEZE. Because of this existing resource, this report will not attempt to repeat a similar summary but instead refer the reader to that document.

As an example of the content, Figure 64 shows the applicability of the existing regulations for LNG bunkering. Two parts of Figure 64 that are of direct relevance to SF-BREEZE bunkering concepts are (1) a fill directly from an LH₂ supply truck/trailer and (2) transferring a portable LH₂ tank between land and the vessel. However it is not clear from the figure which regulations apply. For the first case, "bunkering truck," the truck or trailer itself is regulated by DOT Pipeline and Hazardous Materials Safety Administration under 49 CFR, and the area where the truck/trailer is located and conducting the transfer is regulated under USCG 33 CFR 127 [ref: CG-OES Policy Letter 02-15]. For the second case, "portable tank transfer," Ref [CG-OES Policy Letter 02-15] notes:

In general, these operations should follow the stowage and handling requirements for portable tanks containing hazardous materials in 49 CFR Part 176. Specific details for stowage will need to be reviewed as part of the vessel's design approval process. LNG in portable tanks is a hazardous material listed in the 49 CFR 172.101 Hazardous Material Table. As such, these portable LNG tanks meet the definition of "Dangerous Cargo" in 33 CFR Part 126 and must be loaded from a Designated Waterfront Facility inspected under 33 CFR Part 126.

It is clear that regulations permit LNG bunkering. The question is whether there is anything in the existing regulations that (a) would be impossible to achieve with the proposed bunkering system needed for the SF-BREEZE, or (b) cannot be easily adapted to LH₂ as the fuel. As described below, nothing of this nature was found in existing regulations and LH₂ fueling of the SF-BREEZE is feasible from a regulatory point of view.

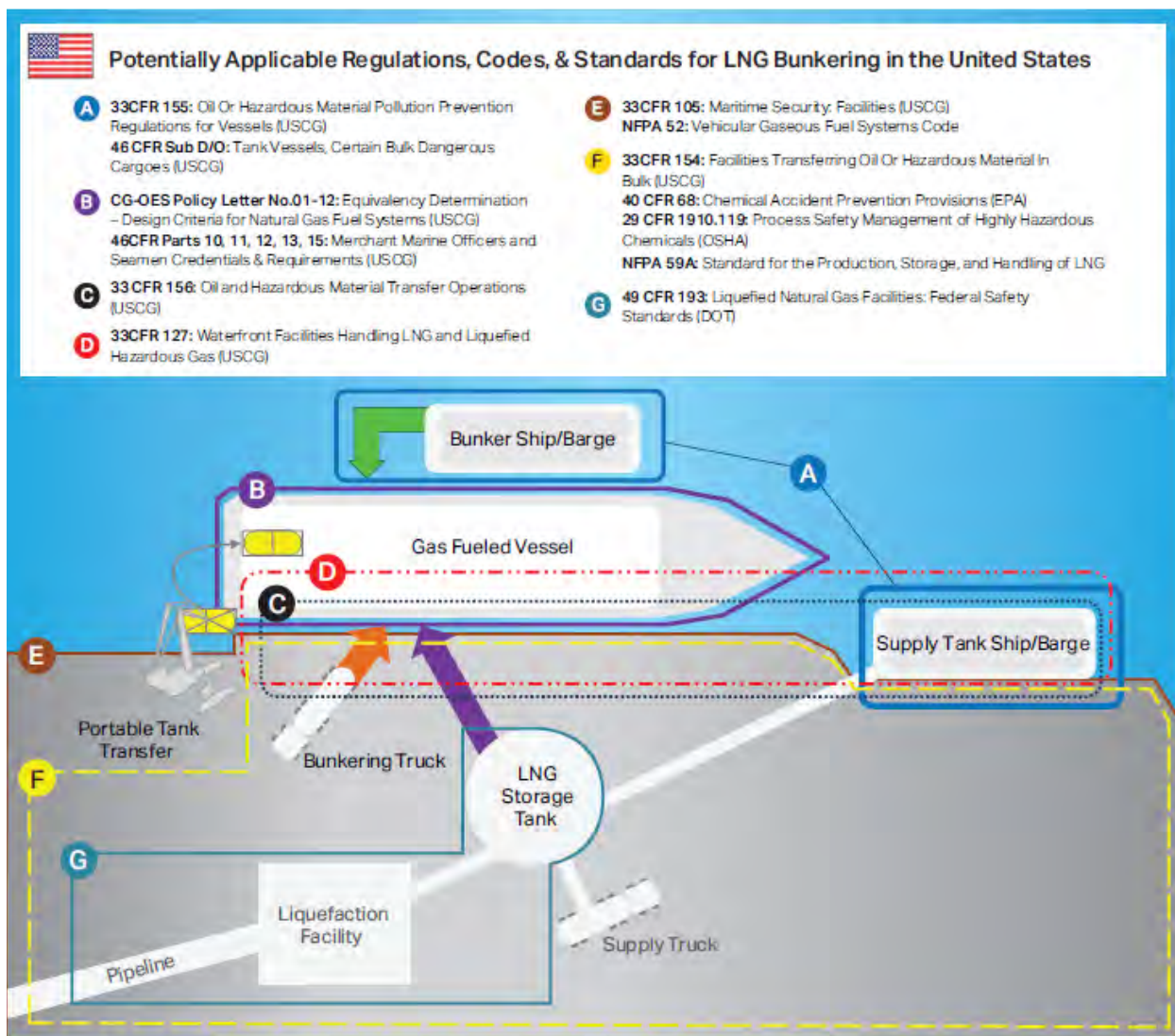

Figure 64: Graphical summary of codes applicable to LNG bunkering, from Ref. [146].

4.2.1 General

Section 3.2.6 describes the fact that although liquid hydrogen has many similarities to liquid natural gas (and likewise, hydrogen gas and natural gas), there are some important fundamental differences, and some of these properties affect best practices in handling hydrogen in both normal operation and emergency situations. This section attempts to identify the portions of existing (LNG) regulations that may need to be examined for applicability to LH₂.

In general, existing regulations and guidance documents commonly include existing standards by reference from organizations such as ANSI, ASME, NFPA, etc. Traditionally, hydrogen has been lumped with other chemicals and fuels such as LNG. However, the recent growth and interest in hydrogen as a fuel in many sectors has resulted in development of specialized standards, but these are not yet incorporated into the bunkering standards by reference. These include, in particular, ASME B31.12 (Hydrogen Piping and Pipelines) and NFPA 2 (Hydrogen Technologies Code). To develop an LH₂

bunkering facility these standards should either be referenced in the over-arching regulation (for example, 33 CFR Part 127) or included as part of the design basis submitted for approval.

4.2.2 33 CFR Part 127

33 CFR Part 127 is the regulation governing waterfront facilities handling liquefied natural gas and liquefied hazardous gas. Currently, 33 CFR Part 127 does not include hydrogen (gas or liquid) within its scope. This would need to be added. The only other part of 33 CFR Part 127 that may need to be modified for suitability with LH₂ is sections 127.601-617 (Firefighting) to ensure the actions required for LNG are still applicable for LH₂. In particular the requirement of a dry chemical system may need to be evaluated for suitability for hydrogen flames in outdoor locations. Rather than directly applying the regulation for LNG, in this case it may be better to use language that provides flexibility such as that in section 127.1509 which describes acceptable firefighting methods for liquid hazardous gases.

4.2.3 29 CFR Part 1910.119 (OSHA PSM)

CFR 29 Part 1910.119 “Process safety management of highly hazardous chemicals” (the OSHA PSM, also summarized in Ref. [147]) governs any facility which has a process containing substances designated as hazardous. It can place a burden on LH₂ bunkering facilities that does not appear to exist for LNG or other fuels. The need to comply with PSM requirements is described in Section 1910.119 and includes: “A process which involves flammable liquid or gas (as defined in 1910.1200(c) of this part) on site in one location, in a quantity of 10,000 pounds (4535.9kg) or more.” For LH₂, this mass corresponds to about 16,900 gallons.

There appears to be an exception for typical bunkering fuels and LNG via 1910.119(a.1.ii.A): “Hydrocarbon fuels used solely for workplace consumption as a fuel (e.g., propane used for comfort heating, gasoline for vehicle refueling), if such fuels are not a part of a process containing another highly hazardous chemical covered by this standard” and 1910.119(a.1.ii.B): “Flammable liquids stored in atmospheric tanks [defined as 0.0-0.5 psig] or transferred which are kept below their normal boiling point without benefit of chilling or refrigeration.”

Although LH₂ is being used for a fuel in the case of the SF-BREEZE, it does not fall into exception (A) because it is not a *hydrocarbon* fuel (this was clarified in an OSHA interpretation [148], and it does not fall into exception (B) because it is typically stored at pressures above 0.5 psig.

OSHA PSM can be precluded if jurisdiction for a facility falls into that of another entity. For example, LNG pipeline facilities are regulated by DOT Office of Pipeline Safety under 49 CFR and the site must follow those requirements. In the case of the SF-BREEZE bunkering facility, however, USCG only regulates the transfer area, which does not include the storage tanks, so PSM would apply. However, PSM requirements only apply to the amount of the chemical contained *within the process*. In the situation where a delivery trailer (a “cargo tank motor vehicle” or CTMV) supplies the LH₂, OSHA has determined that PSM does not apply to the CTMV itself because it is regulated by DOT under 49 CFR. Therefore, a site which has LH₂ delivered by CTMVs and not stored otherwise on site in tanks, piping, or equipment in quantities over 10,000 lb would not be subject to PSM.

The PSM requirements, according to one IGC surveyed, are not impossible to overcome, but “are an extraordinary amount of paperwork and record keeping, on par with a facility that would store really nasty stuff, like nerve agents, explosives, anhydrous ammonia, etc.” The net effect of compliance with PSM is added cost to the operation of an LH₂ bunkering facility. However, as shown above, the SF-BREEZE bunkering facility would not be subject to PSM as long as there is less than 10,000 lb of LH₂ stored within the system, excluding the amounts in any CTMVs.

4.2.4 USCG NVIC 01-2011

This NVIC is written from the viewpoint of LNG shipping terminals as evidenced by its stated purpose of providing guidance to “An owner or operator seeking approval from the Federal Energy Regulatory Commission (FERC) to build and operate a LNG facility, as defined in 33 CFR Part 127”. However, according to both USCG [149] and ABS [146], Federal Energy Regulation Commission (FERC) regulation 18 CFR 153, “*Applications for Authorization to Construct, Operate, or Modify Facilities Used for the Export or Import of Natural Gas,*” which applies to LNG import/export terminals, does not apply to LNG bunkering facilities unless the bunkering facility is co-located with the import/export terminal. So this NVIC would not apply to the SF-BREEZE. However, this NVIC does present a robust framework for the application and approval process and appears to be readily adaptable to future LH₂ cargo terminals in the future

4.2.5 USCG OES Policy Letters 01-15 and 02-15

These policy letters could be readily adapted to LH₂ as-written. None of the requirements would prevent applicability to bunkering the SF-BREEZE with LH₂.

4.2.6 ABS' LNG Bunkering: Technical and Operational Advisory and Bunkering of Liquefied Natural Gas-fueled Marine Vessels in North America

The general concepts in these documents are applicable to LH₂, but the technical content needs to be refined to be consistent with the differences between LH₂ and LNG properties, as described in more detail in Section 3.2.6. While not within the scope of this project to fully evaluate the technical content of these documents and make specific suggestions for revision, the incorporation of four core ABS personnel in the project team and eight other ABS employees in briefings and discussions will directly help with this kind of future revision.

5 Economic Assessment

The economic assessment considers the cost of the ferry, LH₂ facility, and cost of the fuel itself. This section also discusses costs of add-on hydrogen vehicle fueling stations and feasible incentive and grant programs to subsidize the cost.

5.1 Ferry

As part of their design package, EBDG prepared a Parametric Cost Estimate, included in Appendix A. That cost estimate reached the following conclusions:

- The estimated cost of constructing the SF-BREEZE today is \$29,220,000
- The estimated cost of constructing a comparable diesel-powered ferry is \$15,200,000.

This section discusses the main factors in the SF-BREEZE capital cost estimate as well as estimates of the regular operating and maintenance costs.

5.1.1 Capital Cost

The EBDG estimate of today's capital cost of the vessel is based on a typical parametric cost estimating method applied to vessels of any type, with the exception that specific costs for the hydrogen and fuel cell system substituted for traditional diesel fuel and engine costs. Therefore the main driver in cost difference between the SF-BREEZE and a traditional diesel ferry is due to the hydrogen storage, fuel cells, and electrical conversion system.

The fuel cells were estimated to cost \$12,300,000. This was based on the installed power (4,920 kW) combined with estimated fuel cell cost of \$2,500/kW. This cost was given by Hydrogenics as the upper range of expected fuel cell cost today based on a one-time order of 5 MW with ruggedization and marinization options [49]. The lower range was given as \$1,800/kW without the additional options. Since the fuel cells will be located in a controlled environment fuel cell room, the ruggedization and marinization options may be unnecessary, according to Hydrogenics [49].

The hydrogen storage was estimated to cost \$850,000 at today's prices. This was based on cost estimates provided by Sandia from consultation with tank manufacturers (e.g., Ref. [59]) and is not likely to be substantially reduced.

The EBDG estimate justifiably incorporates design margins in an attempt to account for the unknowns of implementing this novel vessel. One of these margins is a 5% additional weight margin imposed as described in Section 3.1.4.3. This margin has a sound technical basis in that it attempts to account for added weight found during detailed design, but for sake of finding a lower bound of the cost estimate this margin will be removed. Removal of this weight margin would reduce required power by 5.5% (as described in Section 3.1.4.4). Other margins included in the speed and powering calculations are margin for head winds and a nominal 9% power margin (installed propulsion power is 9% higher than designed peak power) to account for typical deterioration in powerplant capacity and increased drag over the lifetime of the vessel. These margins are considered essential and not removed for sake of this exercise. Another margin is, as described in Section 3.1.4.4 the speed and powering calculations, the exclusion of consideration of lifting devices. These nominal cost items were estimated by EBDG to be able to reduce

power consumption by 5%-10% (pending detailed hydrodynamic analysis). Assuming the maximum benefit, the power consumption can be reduced by an additional 10%. Finally, the EBDG estimate includes an overall 10% contingency addition to the overall cost. For sake of the purpose of finding a Low capital cost estimate, this will also be removed by assuming the parametric estimate includes enough contingency in its method already.

Based on the above we make the following modifications to the EBDG cost estimate:

1. Removal of the 5% weight margin. This reduces propulsive power by 5.5%, from 4.8 MW to 4.536 MW.
2. Addition of nominal-cost lifting devices with maximum benefit. This reduces propulsive power by 10%, from 4.536 MW to 4.082 MW (4.202 MW total installed power including 120 kW auxiliary loads)
3. Use of \$1,800/kW for the fuel cell price instead of \$2,500/kW. This reduces the fuel cell powerplant cost by \$4,736,400 to \$7,563,600. Assuming the remainder of the vessel cost remains constant, this results in a pre-contingency cost of \$21,986,254.
4. Not including the 10% contingency cost. The overall lower estimated cost of the vessel today remains \$21,986,254.

The capital cost results are summarized in Table 14. It must be noted that the EBDG estimate of a comparable diesel is based on the *Vallejo*, which has twice the passenger capacity as the SF-BREEZE. Further reduction in capital cost of the SF-BREEZE can be obtained by additional reductions in power requirements since the fuel cells are a large fraction of the overall cost.

Long term reductions in powerplant costs are expected as the fuel cell industry production volumes increase. For example, the US Department of Energy predicts that mass manufacturing of fuel cell stacks can reduce costs to nearly \$50/kW at the high volumes (500,000x 80 kW units per year) associated with large scale fuel cell electric vehicle adoption [151]. Such a drastic cost reduction would decrease the originally estimated powerplant cost from \$12,300,000 to just \$246,000 and make the construction cost of the SF-BREEZE equivalent or lower than that of the comparable diesel. While this is a long-term proposition, it shows the cost reduction potential of fuel cells which can be contrasted against the trend of increasing costs of diesel engines due to more stringent emission regulations. Since

Table 14: Summary of SF-BREEZE capital cost estimates including that of a comparable new-build diesel powered ferry.

Vessel	Estimated Cost for Construction Today
SF-BREEZE, High	\$29,220,000
SF-BREEZE, Low	\$21,990,000
Comparable Diesel, 300 passenger ^a	\$15,200,000
Comparable Diesel, 150 passenger ^b	\$8,000,000

^aEBDG estimate

^bUS DOT estimate [150] using the high-end of the range for a Category G craft (150 passenger, 35 knot, 4,000 hp installed power). Does not include added cost of Tier 4 engines and associated emissions control equipment.

the SF-BREEZE uses PEM fuel cells, the SF-BREEZE power plant costs would directly benefit from cost reductions anticipated for PEM fuel cells used in light duty vehicles.

EBDG also estimates that building the hull and structure out of composite material could reduce the weight by 40%. This would result in drastic reduction in power requirement and overall fuel cell cost. A future study could examine the cost trade-off between the higher-cost composite hull (and any regulatory or performance aspects) versus the resulting lower cost of the powerplant.

5.1.2 Operating and Maintenance Cost

Similar to the construction cost estimate, the difference between operation and maintenance (O&M) costs of the SF-BREEZE and a comparable conventional diesel ferry will be due to the powerplant. It is assumed that costs associated with manning requirements and maintenance of other shipboard systems are similar for the two vessels.

The powerplant is divided into four components: (1) fuel cell stacks, (2) fuel cell balance of plant, (3) power conditioning equipment, and (4) electric drive motors. Detailed O&M costs of the first three items were obtained in conversations with Hydrogenics and an assessment of electric motor maintenance was obtained from personnel at Scripps Institution of Oceanography.

Hydrogenics offers long term service agreements (LTSA) with the stacks it sells. The LTSA covers all maintenance in order to guarantee power for 20 years after purchase. Because stacks are estimated to last 10,000-15,000 hours, the major component of this plan is replacement of stacks every few years (based on estimated SF-BREEZE usage, assuming an average of 9 hrs/day usage for 310 days/yr, stack replacement is expected every 3.6 years if the conservative 10,000 hr lifetime is used). At current production volumes (and therefore, current stack costs), and assuming a coverage of 5 MW worth of stacks, an LTSA from Hydrogenics would cost \$290,000 per MW per year, or \$1,450,000/yr for the nominally 5.0 MW SF-BREEZE system (not considering potential power reductions discussed in the previous section) [49]. Most of this cost is due to the cost of the stack membrane itself, so if the company were to achieve higher volume production of fuel cells as a whole, this cost can be drastically reduced. Note that the stack replacement does not require extended down-time of the vessel. The fuel cell units can be replaced individually as needed within several hours.

Current LTSAs are based on the application, taking into account typical yearly usage and predicted replacement interval. The SF-BREEZE ferry is expected to operate for about 9 hrs/day, 310 days/year and at this rate would reach 10,000 hours of operation in about 3.6 years and the LTSA estimate for the SF-BREEZE (above) is based on this usage. However, the fuel cell stacks do not all operate this same number of hours because for portions of the trip some fuel cell stacks can be placed in standby mode which does not count towards lifetime hours. With an operating scheme to optimize efficiency by operating each stack at 8.25 kW (see Section 3.1.5.2) the replacement interval can be increased to 4.7 years, which can potentially decrease the LTSA cost to 76% of that estimated above, or \$1,084,000/yr. In addition, if the more aggressive 15,000 hr lifetime is used, the O&M interval can be extended to 7.1 years, reducing LTSA cost to \$735,000/yr. This can be used as a “Low” estimate for LTSA-related O&M at today’s cost.

The fuel cell balance of plant includes regular maintenance and expected replacements due to normal wear of pumps, motors, blowers, valves, filters, regulators, and sensors. Hydrogenics recommend a yearly budget of 2%-3% of fuel cell powerplant capital cost to cover these items [49]. For the SF-BREEZE, and using a value of 2.5%, this comes to \$307,500/yr.

Power conditioning equipment consists of any DC-DC power converters and DC-AC power inverters. This equipment is typically very reliable when off-the-shelf products are used, but they require routine maintenance such as filter replacements, connector check and other miscellaneous items. We conservatively estimate a yearly budget of 1% of the inverter cost, or \$38,700/yr using EBDG's estimate of the cost of these items.

Electric motors are the last component of the fuel cell powertrain. Mariners at Scripps Institution of Oceanography who work on the R/V Melville, a 297 foot global-class diesel-electric research vessel with two 1,120 kW electric drive motors, state that the motors have extremely little maintenance requirements. Frank Kristiansen, Chief Engineer of Norled's battery-electric *Ampere* passenger+car ferry which has two 450 kW electric motors noted that, other than regular oil and grease checks, the maintenance interval on the electric motors is 50,000 hours and then consists only of bearing replacement. Therefore, no budget is allocated to the O&M of electric motors.

Combining these costs results in a yearly O&M budget of between \$1,081,200/yr (Low) to \$1,796,200/yr (High) due to the fuel cell drive train.

Engine maintenance costs of comparable diesel powered vessels were obtained from San Francisco Bay Ferry and from available literature.

Marty Robbins at San Francisco Bay Ferry aggregated maintenance costs for SF Bay Ferry's four ferries, the *Vallejo*, *Intintoli*, *Mare Island*, and *Solano*, all high speed (32-35 knot) catamarans with ~300 (+/-30) passenger capacity each. Yearly engine maintenance and repair (M&R) costs, including pro-rated cost of engine overhaul at the manufacturer's recommended interval, were tabulated along with total kWh (where kWh was defined as: Engine rating × actual hours × measured load factor for the route). For the time period 2012-2015, the M&R costs for the four ferries averaged \$310,100 per vessel, or \$0.053/kWh [132].

US DOT [150] provides a formula from which a cost of \$480,480/yr can be calculated, assuming a 150 passenger, \$8,000,000 vessel (such as that shown in Table 14) operating 2,790 hrs/yr. With a stated +/- 30% accuracy, The Glosten Associates estimated an average of \$226,650/yr over the 30-year life for the main engine system of a larger diesel powered car ferry, but with similar power (~4.5 MW) as the ferries which are the subject of this study [152]. Table 15 summarizes the O&M cost estimates using today's costs for hydrogen technology.

The primary cause of the higher O&M cost of the SF-BREEZE is due to the LTSA cost of the fuel cell stacks, which in turn is caused by the high price of fuel cell membranes at current production volumes. The previous section on capital cost notes how drastically the fuel cell cost can be decreased with increased volume production. A similar reduction in O&M cost would follow, marginalizing the LTSA

Table 15: Estimated yearly O&M costs for the powerplant of the SF-BREEZE and comparable diesel vessels.

Vessel	Estimated Cost
SF-BREEZE – High	\$1,796,200/yr
SF-BREEZE – Low	\$1,081,200/yr
Comparable Diesel – SF Bay Ferry ^a	\$310,100/yr
Comparable Diesel – US DOT ^b	\$480,480/yr
Comparable Diesel – Glosten ^c	\$226,650/yr

^aPer Marty Robbins, San Francisco Bay Ferry [132]

^bUS DOT estimate [150]

^cGlosten Associates [152]

cost of the SF-BREEZE fuel cell stacks to just \$29,000/yr if achieved. However, even with this type of cost reduction the O&M budget remains at is \$375,200/yr, which by itself is comparable to that of diesel powerplants. This points to a need to increase the service interval and/or reduce the service cost of the fuel cell BOP components and electrical equipment in addition to cost reductions of the fuel cell stacks if fuel cell powerplants are to be considered to have lower maintenance requirements compared to diesel engines (as suggested in Section 1.2).

5.2 LH₂ Facility

With no known LH₂ vessel bunkering facilities in the world, estimating the cost of the facility must be done in a ground-up approach considering the components of the facility. Some of these components have known costs and others have to be estimated from other applications. These components depend on the type of facility being built. Confining the discussion to the concept shown in Figure 43 of Section 4.1.2, the two types of facilities are: (1) bunkering from an on-site stationary tank and (2) bunkering directly from a tanker truck. In this case, the only difference in cost is due to the on-site storage tank. Because of the similarities in handling LH₂ and LNG relative to other fuels (see Section 3.2.6), costs for LNG bunkering equipment is used as the starting point.

The common equipment to both types of facilities is the piping manifold and loading arm. For LNG bunkering this has been estimated to cost \$550,000 [153] and is assumed to be the fully engineered and installed cost complete with all controls and associated civil work (such as foundations, fencing, etc.). As noted in Section 3.2.6, LH₂ and LNG have different physical properties, one being the lower boiling point of LH₂. This means that LH₂ pipes are always vacuum jacketed while the standard LNG piping is not.

Standard LNG piping is insulated with a fiberglass or foam glass insulation and a welded steel outer steel jacket [61, 154]. There is a drastic cost difference between foam glass insulation and vacuum jacket. For example, a 1" vacuum jacketed pipe for 150psi will cost about \$1,000/meter while foam glass insulation with stainless 1" pipe would cost about \$100-\$200/meter.[61] For our purposes we will assume that LH₂ piping costs a factor of 5-times that of LNG piping, and that of the \$550,000 total engineered and installed cost, 10% of this is piping cost. This would give an increased piping cost of \$220,000 due to vacuum jacket versus foam insulation and a total cost of \$770,000.

Reference [153] estimates the cost of one-time licensing and permits fees of the facility to be \$200,000. Although this figure is highly dependent on the local jurisdiction we will use this for a conservative estimate.

There may also be a cost associated with renovating an existing dock or pier, but those are impossible to quantify on a generic basis and must be done for each specific case.

For a truck-to-vessel arrangement, this is all the equipment needed assuming the cost associated with the LH₂ delivery trailer is borne by the LH₂ supplier through the cost of LH₂. The total capital cost of the “trailer fill” bunkering station would therefore be \$970,000 excluding any pier renovation cost. This compares well with an estimate from one IGC of \$800,000-\$1,000,000 a complete direct trailer bunkering facility.[61] Because the first facility would have approximately 40% in non-recurring engineering costs, subsequent similar facilities may have costs reduced to \$400,000.[61]

For a tank-to-vessel arrangement, the cost of the LH₂ tank must be added, assuming all other components are the same. Vendor budgetary estimates were obtained for LH₂ tank costs:

- \$700,000 for a 20,000 gallon (5,350 kg) tank of which \$66,000 is associated piping
- \$440,000 for a 6,000 gallon (1,600 kg) tank of which \$66,000 is associated piping

From the discussion in Section 4.1.2.2 it is clear that a 6,000 gallon tank will be ineffective as an on-site storage quantity. The upper limit before reaching OSHA PSM requirements is 16,900 gallons. For this purpose we will assume a 16,000 gallon tank, which is a standard size, and interpolate the tank-only portion of the costs above for a cost of \$625,000 of which \$66,000 is associated piping. Thus the total cost of a bunkering facility with a 16,000 gallon (4,290 kg) LH₂ on-site storage tank will be \$1,513,000.

For perspective it is useful to compare these results to typical diesel fueling operations. A truck-to-vessel diesel refueling system requires minimal infrastructure as illustrated with the truck delivery operation at Red and White Fleet (Figure 42 of Section 4.1.1). According to RWF, the total capital cost of such infrastructure is essentially zero with only a nominal expense associated with spill response (\$1,000-\$2,000). The diesel delivery truck provides the connecting hoses, nozzles, and spill response equipment and those costs are included in the delivered per-unit price of fuel. Note that the cost for diesel refueling does not include costs associated with cleanup and fines due to diesel fuel spills, which can be substantial (~\$50,000 per event or more, according to RWF).

For storage tank-to-vessel infrastructure for diesel fuel, there will be some cost associated with on-site diesel storage and transfer. Reference [155] estimates an infrastructure cost of \$11/metric ton of throughput for 10 years for either Heavy Fuel Oil or Marine Gas Oil. If the *Vallejo* were to perform the same mission as the SF-BREEZE it would use 3,943,200 gallons of diesel per 10 years of operation (see Section 3.1.5.1 for determination of equivalent fuel use by the *Vallejo*) which is equivalent to 12,539 metric tons of diesel (using a density of 3.18 kg/gallon). This gives an estimated infrastructure cost of \$138,000. This estimate appears extremely low (and was noted as such by the authors of Ref. [155]) considering that new diesel bunkering terminals can cost tens of millions of dollars [156]. Therefore we

Table 16: Estimated capital cost of an LH₂ bunkering facility, excluding any necessary improvements to the host dock or pier.

Facility Type	LH ₂			Total	Diesel
	Piping and Manifold	Permits and License Fees	On-site Storage Tank		Total
Truck-to-Vessel	\$770,000	\$200,000	-	\$970,000	\$1,500
Tank-to-Vessel	\$770,000	\$200,000	\$625,000	\$1,595,000	\$338,000

take this to be just the equipment/installation cost and with the licensing and permitting fees estimated above assume a minimum estimate of \$338,000.

The costs of the LH₂ bunkering facility and an equivalent diesel bunkering facility are summarized in Table 16. The cost of an LH₂ bunkering facility is clearly higher than that needed for diesel refueling. As LH₂ fueling process and technology matures this cost may be somewhat reduced. However, the inherent difference in handling a very cold cryogenic liquid (LH₂) versus a liquid at room temperature (diesel) combined with the additional procedures in place for handling low flashpoint fuels at marine facilities will always result in a higher cost of the LH₂ handling equipment.

5.3 LH₂ Fuel

As described in Section 4.1.4, all of the Industrial Gas Companies (IGCs) surveyed believe they can readily supply the LH₂ needs for the SF-BREEZE. They were requested to provide estimates of the cost to the bunkering facility operator to deliver the LH₂ into the on-site storage tank. This cost includes production and delivery. IGCs were requested to provide pricing for conventionally-produced LH₂ (from natural gas) and for renewable LH₂.

The IGCs noted that more favorable pricing can be obtained when usage is high and a multi-year contract can be executed. This contract is not necessarily a “take or pay” contract where usage is guaranteed, but could be a simple exclusivity contract with a predicted usage. The IGCs in collaboration with the project team determined that a five-year contract would make the most sense and balance the desire of a long-term contract with the uncertainty of the future of such a novel vessel. The following usage specifications were given to two of the IGCs to request budgetary estimates:

- Maximum demand / upper limit:
 - 2,000 kg/day @ 5 days/week (commuter service)
 - 1,000 kg/day @ 2 days/week (tour/light commuter service)
- Availability 310 days/year (85%) due to intermittent days of low demand, maintenance, etc.,
- Length of the agreement: 5 years
- Year-by-year demand profile (to account for uncertainties in the technology and ridership):
 - 50% usage in Year 1
 - 75% in Year 2

- 100% in Years 3-5

Actual predicted hydrogen consumption was estimated in Section 3.1.5.2 to be 1,594 kg/day. That estimate includes fuel usage margin for headwind but not for adverse weather or hull fouling, and is used here to set the floor for total hydrogen consumption. Using this estimate results in the following annual hydrogen consumption:

- Year 1: 211 metric tons
- Year 2: 317 metric tons
- Year 3: 422 metric tons
- Year 4: 422 metric tons
- Year 5: 422 metric tons
- Total for five years: 1,795 metric tons

Based on this demand profile the IGCs estimated they could provide the conventionally-produced LH₂ at today's price between \$6.35/kg to \$7.40/kg. With a nominal "take or pay" guarantee of, for example, 1,000 kg/day the price may be able to be reduced to \$5.90/kg.

No IGCs were able to provide publically-disclosable prices for 100% renewable LH₂. One IGC estimated a 10% cost increase to supply 33% renewable LH₂ (33% renewable is a requirement in California for vehicle fueling stations receiving funding from the California Energy Commission). However, as noted in Section 4.1.4, IGCs have reported they can provide 100% renewable LH₂, and as shown in Section 3.1.5 it is important to use 100% renewable LH₂ in order to achieve GHG reductions compared to conventional technology.

In order to estimate the cost of 100% renewable LH₂, the components of LH₂ production are examined. Reference [157] divides the cost of delivered LH₂ into production (related to feedstock), liquefaction, and truck delivery. The apportionment estimated is:

- Production: 38.5% of cost
- Liquefaction: 45.2% of cost
- Truck delivery: 16.4% of cost

To determine the total cost increase of 100% renewable LH₂ we can determine the cost increase of these components. The cost increase of the production portion due to renewable feedstock can be estimated by the price difference in biogas versus natural gas. The cost increase in the liquefaction portion can be determined by the price difference in renewable electricity versus grid-supplied electricity. We will not consider conversion of the trucking process to renewable fuel such as biofuel. The implication of this is that the overall lifecycle GHG emission of the delivered LH₂ will be greater than zero due to the GHG emissions during trucking even though the LH₂ itself will have zero GHG emission (100% renewable).

For the biogas versus natural gas price difference, in 2013 Southern California Gas estimated an upper end biogas price of 2.5-3.3 times the natural gas price [158], using a natural gas price that appears to be

at the Citygate [159]. A 2008 report by the California Energy Commission [160] gives an estimated biogas production cost 2-5 times higher than natural gas Citygate price at the time of the report. We will use the CEC's 2-5 times range, which includes the Southern California Gas range, to calculate “low” and “high” prices cases.

The liquefaction process is powered primarily with electricity. To make 100% renewable LH₂ all the electricity for liquefaction must also be renewable and the price difference in renewable versus conventional electricity must be taken into account. Figure 65 (from Ref. [161]) shows recent prices of electricity paid by California’s Investor Owned Utilities where the renewable (“Renewables-RPS”¹⁷ and “Renewables-QF”¹⁸) electricity prices are compared to other sources of electricity. Figure 66 from the same reference shows the amounts of each category actually purchased by the utilities. Weighting the costs by the amounts purchased, a price multiplier of 1.83 is revealed for the two renewable power cases versus the other three cases. This is assumed to be worst case, since the “Short Purchases” and “Cogeneration” categories could contain some renewable aspects but here are treated as non-renewable.

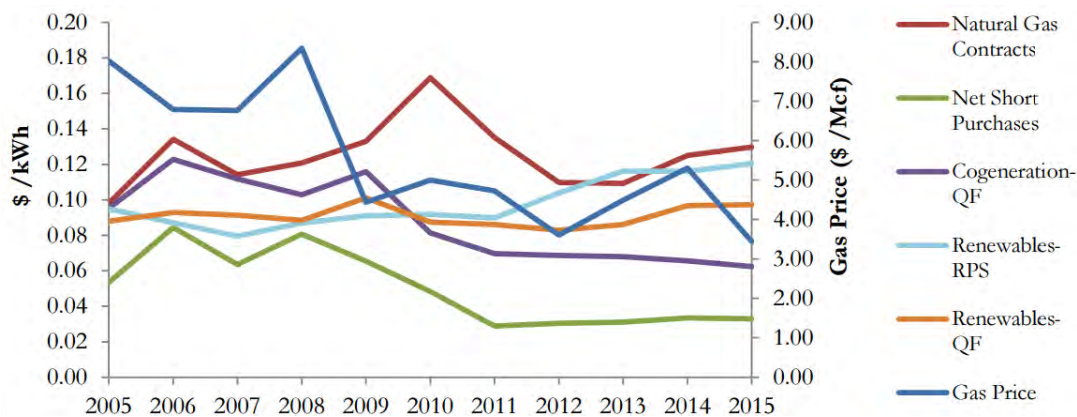

Figure 65: Average cost of different types of purchased power by California’s Investor Owned Utilities. Figure 3.5 from Reference [161]. See footnote in text for definition of acronyms.

¹⁷ RPS = Renewable Portfolio Standard. An RPS facility is one which qualifies under the terms of the RPS legislation in California, which requires a percentage of total retail electricity sales to come from eligible renewable resources. The RPS targets are set at: 33% by end-of-year 2020, 40% by 2024, 45% by 2027, and 50% by 2030.[161]

¹⁸ As defined by Ref. [161], QF = Qualifying Facility: a generation facility that qualifies to sell power to the utilities under the Federal Public Utility Regulatory Policies Act (PURPA). PURPA requires Investor Owned Utilities to interconnect with and purchase power from QFs at rates that reflect costs the utility avoids by buying QF power instead of procuring power from other sources.

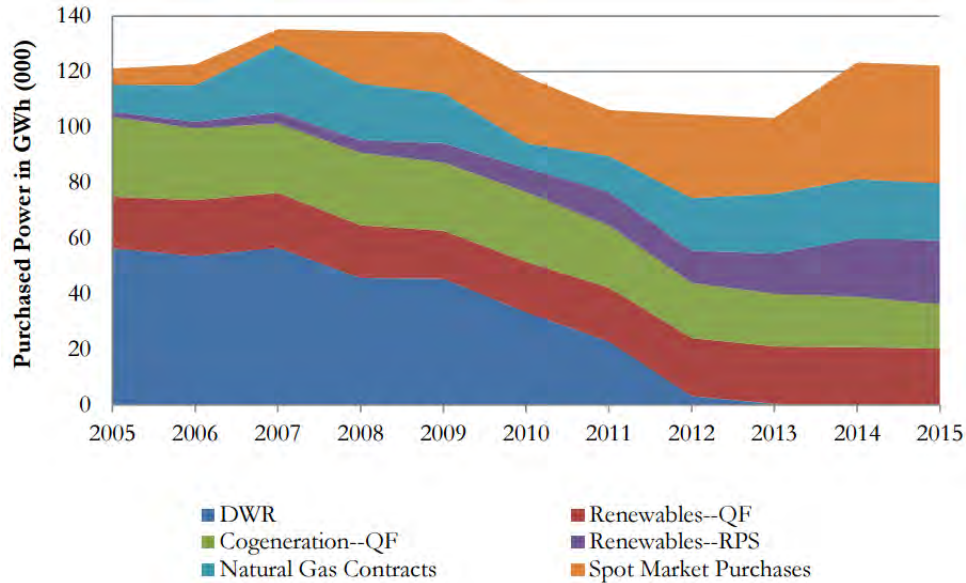

Figure 66: Distribution of type of power purchased by California's Investor Owned Utilities from Qualifying Facilities (generators). Figure 3.2 from Reference [161]. See footnote in text for definition of acronyms.

The low and high ranges of 100% renewable LH₂ can then be calculated considering the low and high ranges of natural gas produced LH₂ given by the IGCs (\$6.35/kg to \$7.40/kg, and \$5.90/kg with a nominal “take or pay” commitment) and the 2x (low) and 5x (high) multiplier of biogas versus natural gas discussed above. The result is the following cost ranges for renewable LH₂:

- Take or Pay low range, biogas effect: $\$5.90 \times 0.385 \times 2.0 = \$4.54/\text{kg}$
- Take or Pay low range, liquefaction electricity effect: $\$5.90 \times 0.452 \times 1.83 = \$4.88/\text{kg}$
- Take or Pay low range, transportation: $\$5.90 \times 0.164 = \$0.97/\text{kg}$
- **Total, Take or Pay low range, 100% renewable LH₂: \$10.39/kg**
- Low range, biogas effect: $\$6.35 \times 0.385 \times 2.0 = \$4.89/\text{kg}$
- Low range, liquefaction electricity effect: $\$6.35 \times 0.452 \times 1.83 = \$5.25/\text{kg}$
- Low range, transportation: $\$6.35 \times 0.164 = \$1.04/\text{kg}$
- **Total, low range, 100% renewable LH₂: \$11.18/kg**
- High range, biogas effect: $\$7.40 \times 0.385 \times 5.0 = \$14.25/\text{kg}$
- High range, liquefaction electricity effect: $\$7.40 \times 0.452 \times 1.83 = \$6.12/\text{kg}$
- High range, transportation: $\$7.40 \times 0.164 = \$1.21/\text{kg}$
- **Total, high range, 100% renewable LH₂: \$21.58/kg**

Note this does NOT include any additional expense to making the transportation of the LH₂ renewable, e.g. using biodiesel-fueled tractor trailers.

These costs are summarized in Table 18. The 100% renewable price is predicted to be between 1.76 to 2.92 times higher (76% to 192% higher) than natural gas produced LH₂. This non-linearity when compared to the 10% premium estimated by one IGC for 33% renewable illustrates the added level of difficulty in producing 100% renewable LH₂ compared to 33% renewable LH₂. One factor in this is likely

that the California electricity grid already has more than 33% renewable (non-GHG producing) content (35% according to the 2014 power mix [66]) which makes the electrical portion of LH₂ production inherently 33% renewable with no additional effort or cost. As a check on this conclusion, the calculation method is applied to a 33% renewable low range case:

- Low range, biogas effect (33%): $(\$6.35 \times 0.385 \times 2.0 \times 0.33)$ [33% biogas portion]
 $+ (\$6.35 \times 0.385 \times 0.67)$ [67% natural gas portion] = \$3.25/kg
- Low range, liquefaction electricity effect (using grid mix, no premium): $\$6.35 \times 0.452 = \$2.87/\text{kg}$
- Low range, transportation (unchanged): $\$6.35 \times 0.164 = \$1.04/\text{kg}$
- **Total, low range, 33% renewable LH₂ (calculated): \$7.16/kg**

This is in good agreement with the 10% price premium estimated for 33% renewable LH₂ (\$6.99/kg) by the IGCs. The Take or Pay Low and the High estimates were also calculated this way and included in the table.

One adjustment to these costs can be made in California where the state has instituted a Low Carbon Fuel Standard (LCFS) program which provides monetary credits for alternative fuel production or use. The amount of the credit depends on the open-market pricing of LCFS credits, the carbon intensity of the production pathway, the use application, and the year of the credit.

Table 17 describes estimated LCFS credits potentially available for the three fuel pathways considered when replacing diesel with hydrogen in heavy-duty fuel cell vehicles (used as a substitute for the ferry) in 2016.

Table 18 summarizes the range of hydrogen costs determined above including the effect of an LCFS credit.

To understand the impact of these prices on ferry operating cost it is useful again to compare again the SF-BREEZE ferry to the *Vallejo*. For each one-way trip of the ferries between Vallejo and the San Francisco Ferry Building, Section 3.1.5.2 estimated the SF-BREEZE to consume 199.2 kg of LH₂ while the *Vallejo* would consume 159 gallons of ultra-low sulfur diesel (ULSD). Scaling the hydrogen consumption

Table 17: Estimated Low Carbon Fuel Standard (LCFS) credits for hydrogen from three production scenarios.

Type of LH ₂	Carbon Intensity	Credit for \$87/MT ^b	Credit for \$25/MT ^c	Credit for \$120/MT ^d
Natural gas, marginal renewable content	144.95	\$0.47/kg	\$0.13/kg	\$0.65/kg
33% renewable biogas and electricity^a	111.95	\$0.81/kg	\$0.23/kg	\$1.12/kg
100% renewable biogas and electricity^a	25.84	\$1.71/kg	\$0.49/kg	\$2.36/kg

^aPathway is not currently certified, estimated from existing similar pathways. Carbon Intensity is estimated and credit would not be available until the pathway is submitted to CARB and certified.

^bFrom July 2015-June 2016 the average LCFS traded at \$87/MT.

^cFrom July 2014-June 2015 the average LCFS credit traded at \$25/MT.

^dPeak LCFS trading price to-date was \$122/MT in February 2016.

Table 18: Summary of expected LH₂ costs for the SF-BREEZE today.

Type of LH ₂	Take or Pay Low Estimate with LCFS credit*	Take or Pay Low Estimate	Low Estimate	High Estimate
Natural gas, marginal renewable content (from IGCs)	\$5.43/kg	\$5.90/kg	\$6.35/kg	\$7.40/kg
33% renewable content (from IGCs)	\$5.68/kg	\$6.49/kg	\$6.99/kg	\$8.14/kg
33% renewable content (calculated)	\$5.82/kg	\$6.63/kg	\$7.16/kg	\$10.99/kg
100% renewable biogas and electricity (calculated)	\$8.68/kg	\$10.39/kg	\$11.18/kg	\$21.58/kg

*Assuming LCFS credits trading at \$87/MT.

estimates given to the IGCs for price estimates by this usage ratio (ULSD:LH₂ = 0.803) gives the following comparable diesel consumption for the same five-year period:

- Year 1: 211 metric tons LH₂ (SF-BREEZE) or 169,600 gallons ULSD (*Vallejo* on same route pattern as SF-BREEZE)
- Year 2: 317 metric tons LH₂ (SF-BREEZE) or 254,300 gallons ULSD (*Vallejo*)
- Year 3: 422 metric tons LH₂ (SF-BREEZE) or 339,100 gallons ULSD (*Vallejo*)
- Year 4: 422 metric tons LH₂ (SF-BREEZE) or 339,100 gallons ULSD (*Vallejo*)
- Year 5: 422 metric tons LH₂ (SF-BREEZE) or 339,100 gallons ULSD (*Vallejo*)
- Total for five years: 1,795 metric tons LH₂ (SF-BREEZE) or 1,441,000 gallons ULSD (*Vallejo*)

According to RWF, their current price of ULSD is \$2.15/gallon. Table 19 compares the five-year costs of fuel using this price of ULSD and the lowest and highest estimated prices of LH₂ from Table 18. It also includes an estimate of the “breakeven” price of diesel fuel at which point the five-year costs of both fuels are equivalent.

The best-case cost of LH₂ is 3.1 times that of today’s diesel cost, and for 100% renewable LH₂ the cost is 5.0 times higher (best case). If renewable LH₂ becomes more ubiquitous and if the cost of using fossil fuels increases due to dwindling supplies and/or regulation (e.g., carbon tax), this margin will be reduced. However, the current difference is undeniable and primarily due to two factors: (1) the different energy requirements of making both fuels: as discussed in Section 3.1.5.3, it takes more than

Table 19: Comparison of total fuel costs for five years of operating the SF-BREEZE with LH₂ using unit hydrogen costs from Table 18, and a ferry with the same yearly route profile powered by ultra-low sulfur diesel (ULSD) at today’s prices.

Fuel Type	ULSD Today	LH ₂ Take or Pay Low with LCFS credit	Breakeven ULSD	LH ₂ High	Breakeven ULSD
Non-renewable	\$3.1M	\$9.7M	\$6.76/gallon	\$16.7M	\$9.22/gallon
Renewable	N/A*	\$15.6M	N/A*	\$48.7M	N/A*

*Biodiesel is a renewable diesel fuel but costs are not estimated because a diesel engine running on biodiesel will not meet the requirement for zero emissions at the stack.

7.0 times more energy to make LH₂ than it does to make diesel; and (2) as discussed in Section 3.1.4.4, the SF-BREEZE is not as energy efficient as the comparable diesel ferry on a per-passenger basis. The latter is a key issue that affects not only capital cost but here we see it has a large impact on fuel cost as well and points to a need to maximize passenger capacity when designing hydrogen fuel cell vessels with today's technology.

5.4 Hydrogen Vehicle Fueling Station

The advantages of a co-located hydrogen vehicle fueling station were described in Section 4.1.5. Unfortunately the primary benefits are not associated with reductions in capital or operating expenses of the ferry or its bunkering facility outside the potential to recapture small amounts of hydrogen vented during cool-down.

Despite this, the other benefits described in Section 4.1.5 may be attractive enough to pursue co-location of such a station. Hydrogen vehicle fueling station costs have been well-characterized in Reference [140]. Cost depends on station capacity (amount of hydrogen able to be dispensed in a single day) and type of hydrogen supply (delivered gas or liquid) as well as other details. Station capital costs vary from just under \$1M for a small (100 kg/day) station supplied by gaseous hydrogen to \$1.5 million for a 300 kg/day station supplied by liquid hydrogen. IGCs have independently estimated the latter kind of station can cost more than \$2.0 million, which is consistent with current funding awards from the California Energy Commission [162].

For a liquid supplied station, one area of potential capital cost reduction can occur if the vessel bunkering facility and the vehicle fueling facility share the same LH₂ storage tank, or, for direct truck-to-vessel fueling, this tank could be eliminated from the vehicle fueling station entirely. This could reduce the cost of the vehicle fueling station by approximately \$300,000 but would not affect the cost of the LH₂ bunkering facility.

While the direct economic advantage to the vessel bunkering facility of a co-located hydrogen vehicle fueling facility is unclear, an indirect economic advantage for incorporating a vehicle hydrogen station into the fueling complex is the fact that there are currently subsidies to build vehicular hydrogen stations. In the case where a vehicular fueling portion of the complex is installed at the same time or prior to installation of the vessel fueling portion, common costs including permitting and environmental reviews may be covered by the (subsidized) vehicle station development.

5.5 Societal Economic Benefit

The links between air pollution, human health, and societal economic impact are well documented.¹⁹ Operating the SF-BREEZE instead of a conventional ferry with diesel engines would avoid substantial emissions of criteria air pollutants and greenhouse gases. This section explores the economic value to society of these avoided emissions.

Section 3.1.5.4 revealed the reduction in well-to-waves criteria air pollutant emissions that would result from operating the SF-BREEZE with 100% renewable fuel as compared to a conventional ferry with state-

¹⁹ For example, U.S. EPA's Clean Air Act website: <https://www.epa.gov/clean-air-act-overview>

Table 20: Yearly well-to-waves pollutant emissions of a comparable ferry with Tier 4 diesel engines, the SF-BREEZE, and the annual emissions avoided by building and operating one SF-BREEZE ferry instead of one Tier 4 diesel ferry.

Pollutant	150 passenger diesel with Tier 4 engines	SF-BREEZE with 100% renewable fuel via electrolysis	Avoided emissions with the SF-BREEZE
NOx	5,480 kg/yr	49.5 kg/yr	5,430 kg/yr
Particulate Matter (PM)	122 kg/yr	1.73 kg/yr	120 kg/yr

of-the-art Tier 4 diesel engines. The resulting yearly emissions are summarized in Table 20 for a 150 passenger SF-BREEZE and a 150 passenger diesel ferry powered by Tier 4 engines, operated for 310 days/year (as specified in Section 5.3).

Estimating the impact of pollutant emissions on human health is complex. It includes an analysis of atmospheric chemical processes, assessment of population distribution, estimates of human exposure to harmful compounds, and other factors. Such an analysis is beyond the scope of this study but we can approximate the impact by examining studies in the literature dedicated to this issue and forming correlations based on those results.

Caiazza et al. estimated the impact of air pollution on the U.S. population examining the major combustion sectors and the criteria pollutants PM, NOx, and SOx.[163] By correlating the number of premature deaths to the exposure due to these pollutants found in Ref. [163], and applying this correlation to the avoided emissions in Table 20, we found a societal benefit of \$7.4M over the SF-BREEZE’s 30 year lifetime. This method may overestimate the effect of SF-BREEZE-related emissions reductions because Caiazza et al. includes the impact of SOx emissions but our analysis does not. However, if we included the 5 ppm sulfur found in ULSD it would offset this to some degree, and furthermore it has been shown in the literature that reduction in SOx does not necessarily lead to reduced health effects when NOx is also present because of the complex relationship in atmospheric chemistry of SOx and NOx.[164]

More recently Barrett et al. estimated the impact of Volkswagen’s emission control defeat devices on additional NOx pollution and its health effect on the U.S. population.[165] A correlation was formed from that work and similarly applied to the avoided emissions in Table 20, resulting in an estimated societal benefit of \$2.3M over the SF-BREEZE’s 30 year lifetime. The Barrett et al. study does not consider the effect of emitted particulate matter (PM) so using this method may underestimate the effect of SF-BREEZE emissions reductions, although again the relationship in atmospheric chemistry is complex.

The U.S. Environmental Protection Agency (EPA) examined studies in the literature and provided per-ton societal cost estimates based on industrial sector.[166] The values change depending on the year to account for an increasing “value of a statistical life”. To estimate the total effect of the SF-BREEZE over its 30 year life we used data for the year 2030, which is the closest available date to the midpoint of the SF-BREEZE’s life assuming it is built today. The EPA notes that its valuation of health effects beyond 2024 are likely under-predicted by its method due to economic factors set constant at 2024 values

because predictions beyond that date are unavailable. Nonetheless, we calculate Low and High estimates using the reported method and find a range between \$2.2M to \$5.4M. These values correspond well to those found by the previous two methods described above.

The variation of results by utilizing the three sources described above is indicative of the wide uncertainty in estimating the formation of health-affecting chemicals in the atmosphere, exposure of the population, and damage caused by that exposure. However, these results are given here as an order-of-magnitude quantification of the societal benefit of the zero emission SF-BREEZE ferry and form a reasonable upper and lower bound as shown in the first row of Table 21.

The methods from Caiazzo et al. and Barrett et al. only consider the economic impact of premature mortality; they do not include lesser effects such as increased hospital admissions, respiratory illnesses, and lost work or school days. Previous studies have shown the economic impact of these additional effects is estimated to add 2%-20% to the overall economic impact of pollution [164, 166], which in this case is added to the calculation of benefits due to deploying an SF-BREEZE ferry, as shown in the second row of Table 21.

The U.S. EPA has also determined a Social Cost of Carbon (SCC) which estimates the economic impact of greenhouse gas considering such effects as agricultural productivity, human health, flood damage, and value of ecosystem services.[164] SCC estimates are in the \$6 - \$40 (per metric ton of CO₂) range. Using the CO₂ emission values from Figure 29 in Section 3.1.5.3, operating an SF-BREEZE ferry instead of a comparable Tier 4 diesel ferry can save over 53,000 MT of CO₂ over 30 years. This corresponds to a range of SCC between \$320,000 (for \$6/MT) and \$2,100,000 (for \$40/MT) and is included in the third row of Table 21.

Table 21 summarizes the overall societal economic benefit of operating a single SF-BREEZE ferry with 100% renewable fuel instead of a conventional ferry with state-of-the-art Tier 4 diesel engines. The total benefit is estimated to be between \$2.6M and \$11M. If the SF-BREEZE is used to replace an existing ferry with more polluting engines (Tiers 1, 2, or 3) the societal economic benefit will be increased significantly.

Table 21: Summary of societal economic benefit by building and operating one SF-BREEZE ferry for 30 years instead of one comparable conventional ferry with Tier 4 diesel engines. Estimates rounded to two significant figures in this table, but all calculations are performed with the unrounded estimates.

Benefit	Economic value over 30 year operation	
	Low	High
Avoided Early Deaths	\$2,200,000	\$7,400,000
Avoided Other Health Costs^a	\$45,000	\$1,500,000
Avoided Social Costs of Carbon	\$320,000	\$2,100,000
Total benefit	\$2,600,000	\$11,000,000

^aThe “Low” and “High” values of Avoided Other Health Costs corresponds to 2% and 20% of the Avoided Early Deaths amount, respectively.

5.6 Overall Economic Conclusions

Table 22 summarizes the various costs of the SF-BREEZE ferry with comparison to a conventional diesel ferry. Compared to the conventional diesel ferry, the SF-BREEZE is considerably more expensive to build and operate.

5.6.1 Future Outlook

The capital and O&M costs of the vessel today are expected to only decrease as fuel cells become more ubiquitous, which is highly dependent on the mass adoption of fuel cell electric vehicles.

Fuel costs are also considerably higher today for the SF-BREEZE compared to conventional diesel. Looking towards the future, the energy intensity of producing non-renewable LH₂ makes it highly dependent on mass energy prices, especially natural gas which is used for the feedstock and for a significant portion of the electric power needed to produce it. It is likely that natural gas prices will increase in the long-term future which would mean a corresponding increase in non-renewable LH₂ prices.

Renewable LH₂ should experience an opposite trend, with costs decreasing in the future. A dedicated biogas plant with LH₂ production could generate LH₂ without any external inputs leaving the cost dependent on the amortization of capital of building such a facility. Alternatively, a dedicated solar or wind farm, hydroelectric facility, or nuclear power plant could achieve the same result via electrolysis. As these renewable energy generation and conversion technologies mature and decrease in cost, LH₂

Table 22: Summary of economic costs and benefits of the SF-BREEZE, including future outlook, with comparison to conventional diesel.

	SF-BREEZE			Conventional Diesel	
	Low	High	Future	Low	High
Costs					
Capital cost	\$21,990,000	\$29,220,000	\$17,166,000 ^a	\$8,000,000	\$15,200,000
Yearly powerplant O&M	\$1,081,200	\$1,796,200	\$375,200 ^a	\$226,650	\$480,480
5-year non-renewable fuel	\$9.7M	\$15.6M	Higher	\$3.90M	
5-year 100% renewable fuel	\$16.7M	\$48.7M	Lower	N/A	N/A
Fueling infrastructure	\$970,000	\$1,595,000	Lower	\$1,500	\$338,000
Benefits					
Economic benefit to society of emission reductions	\$2,600,000 to \$11,000,000			\$0	

^aVery high volume production of fuel cells, corresponding to a mature fuel cell vehicle market, but without any of the margin reductions discussed in Section 5.1.1.

cost will also come down. These renewable generation scenarios also insulate LH₂ costs from fossil energy costs enabling a stable long-term fuel cost while fossil fuel energy costs continue to increase.

The costs associated with LH₂ bunkering are likely going to decrease in the future. Even though the materials used to handle and transfer LH₂ today has existed for decades and little cost reduction is expected there, the first LH₂ bunkering facilities built will include significant (~40%) non-recurring engineering expenses that would be eliminated in future installations. There is also continual innovative LH₂ storage and handling R&D at places like the Cryogenics Test Laboratory at NASA Kennedy Space Center, so it is possible that a scientific breakthrough could further reduce this cost in the future.

5.6.2 Parallels to Fuel Cell Electric Vehicles

When comparing the SF-BREEZE to conventional diesel ferries, it is helpful to keep in mind the analogue to passenger vehicles. Fuel cell electric vehicles (FCEVs) have been the subject of billions of dollars of investment over decades by automakers worldwide. In 2014, the first publically available, commercial production fuel cell vehicle (the Hyundai Tucson ix35 FCEV) was sold. In 2015 the Toyota Mirai became the second FCEV publically available. Honda has announced the FCX Clarity will become publically available in late 2016. Both currently available vehicles have list prices of approximately 2-times that of a comparable gasoline vehicle, and it has been speculated that the vehicles cost more to make than the retail price. Recent retail prices of hydrogen fuel at public stations costs between \$10/kg to \$14/kg. FCEVs are touted as having double the efficiency of gasoline vehicles which means that half the fuel is needed for the same driving distance, putting equivalent cost of hydrogen at \$5/kg to \$7/kg. This is approximately 2-3 times more than current retail gasoline prices in California.

Despite these obvious cost premiums of FCEVs versus gasoline vehicles, not only have vehicle manufacturers determined that they have enough commercial viability to launch a product in the market, they have also sold existing vehicles and have long waiting lists of customers. In fact, the major issue holding back sales of FCEVs is not manufacturing limitations or lack of customers (or, therefore, cost), it is the lack of fueling stations.

It is likely not a coincidence that the first US State where FCEV manufacturers are releasing vehicles to the public is California. California has a Zero Emission Vehicle (ZEV) mandate under which automakers are required to ensure a specified percentage of their vehicles sold are zero emission, or face a \$5,000 fine for each vehicle short of the requirement (as described in the California Code of Regulations 13 CCR Section 1962.2 and California Health and Safety Code 43211). Currently, battery electric vehicles (BEVs) make up all but a small fraction of the ZEVs sold to meet this mandate. Automakers realize that BEVs do not meet the range requirements and recharging times for all customers and FCEVs are an additional ZEV option in the marketplace.

Considering the to-date success of the FCEV market in spite of nominally 2-times higher capital and fuel costs than conventional technology, two points stand out as potentially applicable to the SF-BREEZE or similar zero emission vessels:

1. Cost parity is not necessary to achieve public acceptance. Zero emission technology can have benefits that some customers are willing to pay a premium for in the early stages of technology introduction.
2. Zero emission regulations are effective in encouraging deployment of the technology.

5.6.3 Today's Cost Reduction Strategies

Adoption of zero emission hydrogen vessels today, with no regulation in place to encourage zero emission marine transport, will likely require lower costs than described in Table 22. Various parts of this report have identified the core issue with the SF-BREEZE design: it is energy-inefficient on a per-passenger basis. This results in a high propulsive power requirement, which increases the need for its highest-cost item, the hydrogen fuel cells. A more focused discussion on potential design changes is included in Chapter 6.

A second cost reduction strategy is to consider the use of non-renewable LH₂ in the initial stages of the SF-BREEZE operation. Because of the increased per-passenger GHG emissions associated with this strategy in the current design of the SF-BREEZE compared to a conventional diesel ferry, this strategy is not likely to be accepted by itself. It should be done in conjunction with potential design changes so that resulting per-passenger GHG emissions can be brought to no more than equal to existing technology. This would not be a permanent solution, but would allow demonstration of the technology in this application allowing a new standard for “best available compliance technology” which can be used to inform future favorable regulations. In addition, this strategy increases public engagement and may help to develop favorable attitudes if some of the qualitative benefits described in Section 1.2 are realized. In fact this strategy is another parallel to the FCEV rollout currently underway.

5.7 Incentive and Grant Programs

Another near-term cost reduction strategy is to use grants and/or loans to decrease the necessary capital and O&M outlay by the owner. Some programs are highlighted in this section.

5.7.1 Federal Programs

MARAD's Federal Ship Financing Program (referred to as Title XI) provides U.S. Government guaranteed loans to ship owners who finance construction of vessels at US shipyards. Approximately available subsidy for Title XI is \$42 million as of May 2016. This subsidy amount equates to approximately \$518 million in loan guarantees at the average risk rating for projects MARAD has guaranteed over the last 10 years. In the past, guarantees have been made as little as \$4M to over \$1B for an individual project.

MARAD also offers federal tax deferral programs to assist in the cost of building or repairing vessels. The two programs offered are the Capital Construction Fund and the Capital Reserve Fund.

US DOT's Transportation Investment Generating Economic Recovery (TIGER) Discretionary Grant program provides funds to invest in road, rail, transit and port projects that promise to achieve critical national objectives. TIGER funds are meant for infrastructure and give preference to multi-modal facilities as well as those with environmental benefits. However, application is extremely competitive and a well-developed project with pre-approved environmental impact clearance (such as NEPA or

CEQA) is imperative. TIGER funds currently are not usable for a vessel. The TIGER III program has a budget of \$527M. Individual 2015 TIGER awards ranged from \$1M to \$25M.

US DOT Federal Transit Administration's Passenger Ferry Grant Discretionary Program provides grants for supporting existing ferry service, establishing new ferry service, and repair and modernizing ferry boats, terminals, and related facilities and equipment. However, funds may not be used for operating expenses, planning, or preventive maintenance. 2015-2016 funded projects totaled nearly \$59M with individual project awards ranging from less than \$300,000 to \$6M.

5.7.2 State of California Programs

The California Energy Commission (CEC) has a \$100M annual budget until 2023 dedicated to alternative fuels and vehicles. Of this, currently \$25M of the \$100M is for Medium and Heavy Duty Advanced Technology Demonstrations (the amount may change year-to-year). This fund is for the vehicles themselves, not the infrastructure. It has not before funded maritime vessels, only on-road and off-road vehicles but proposals for maritime vessels may be accepted.

The \$100M CEC budget also includes \$20M for hydrogen fueling stations for light duty vehicles over the next 2-4 years. However, these funds are specifically for stations that meet passenger vehicle fueling standards.

The California Air Resources Board (CARB) administers funds from the Greenhouse Gas Reduction Fund (a.k.a. "GGRF" or "Cap and Trade" fund). The amount in the fund depends on the legislature. In 2015-2016 the fund was \$350M, but the legislature only released \$90M of that. GGRF funds have to be for the vehicle. A ferry is acceptable, and marine vessels have been funded by this pathway before. In fact, the 2015-2016 GGRF included \$9M in a specific category for "non-freight, off road, passenger transport" which would directly apply to a ferry. There is a requirement that 10%-25% of the funds have to be used within a defined "disadvantaged community" which considers socioeconomic status combined with criteria pollutant concentrations, an additional 10%-25% of funds have to be used to benefit a disadvantaged community.

CARB also administers the Carl Moyer Memorial Air Quality Standards Attainment Program (Carl Moyer Program) which provides grants for replacement of engines and equipment with cleaner emitting versions. Recently, the guidelines were changed to allow the Carl Moyer Program to also fund development of supporting infrastructure. CARB staff is currently writing the guidelines on eligible projects and it is possible that a zero emission ferry and/or fueling facility could qualify for future Carl Moyer Program funding. CARB staff plans to submit the revised guidelines in Spring 2017 with board consideration closely following. If approved, local air districts (who administer the funds) could use the new guidelines to fund projects starting with application acceptance as early as Summer 2017 for project starts in 2018. The Carl Moyer Program has annual budgets of about \$60M.

CARB funds are only available to public agencies (such as the regional air quality districts) and non-profits.

California's Infrastructure Bank ("IBank") can issue bonds to enable financing clean energy projects for non-profits.

Local air agencies or port authorities also have funding opportunities. For example, the Bay Area Air Quality Management District administers several air quality improvement incentive programs [167]. The Ports of Los Angeles and Long Beach jointly administer the Technology Advancement Program (TAP), which includes in its mission projects which can reduce emissions of marine vessels [168].

5.7.3 Other Opportunities

Other opportunities include private financing, foundations, and donors. Private financing could be from local businesses that see an opportunity for water transit beyond what is provided today. Example donor support would be from organizations or individuals dedicated to protecting the waters of the San Francisco Bay or the environment in general.

6 Conclusions and Recommendations for Future Development

A high speed passenger ferry was chosen as the subject hydrogen fuel cell vessel for this feasibility study partly because of its clear commercial application and familiarity to the project originator, Red and White Fleet. To the project team, just as important in this choice was the fact that a high speed passenger ferry would stretch the limits of feasibility in ways that low speed and/or cargo vessels could not. The team felt that if feasibility of a zero emission hydrogen vessel was demonstrated with a high speed craft, the conclusion would apply to a wider range of other commercial vessels.

This study concludes that a zero-emission high-speed, 150-passenger vessel and its associated hydrogen station are both technically feasible, with no technical or regulatory show-stoppers identified, and that the vessel will be acceptable from a regulatory perspective once a more detailed “ready-to-build” design is generated.

These conclusions were reached after careful consideration of vessel design with a novel fuel and powerplant, implementation of liquid hydrogen as a fuel including on-board safety and bunkering logistics, existing and developing regulations, and development of actual candidate bunkering sites. There is no reason to believe these conclusions would be different for slower vessels or vessels with larger passenger capacity, although this would need to be verified.

However, the economics of the SF-BREEZE high speed ferry are challenging in the near term given 1.5-2 times increase in capital cost and the roughly 3-10 times higher operating cost if it were to be built and operated today. The situation improves if the expected reductions in hydrogen technology (fuel cells, tanks, etc.) costs occur. As mentioned in various places, the high capital and operating cost differential is due primarily to the high cost of fuel cell technology today. This problem is exacerbated by the lower transportation efficiency of the SF-BREEZE on a per-passenger basis, which in turn is due to the higher weight of the vessel.

6.1 Recommendations

6.1.1 Examination of Optimal Performance Requirements for the SF-BREEZE

This feasibility study has shown that the SF-BREEZE can work as designed, serving the ferry needs of the San Francisco Bay Area for transport at high speeds. However, at the start of the project, the team did not appreciate the uniqueness of the application specified by the SF-BREEZE’s performance requirements. To illustrate, Figure 67 plots the results of a DOT survey of ferries in the U.S. in 2014. The conceptual SF-BREEZE is overlaid as a red star. From this chart it is clear that the SF-BREEZE is an outlier to the normal ferry being operated in the U.S.

Figure 68 shows the distribution of US ferry speeds. Besides reinforcing the fact that the 35 knot SF-BREEZE is in the minority, this chart reveals that the most common ferry speed is between 6-15 knots.

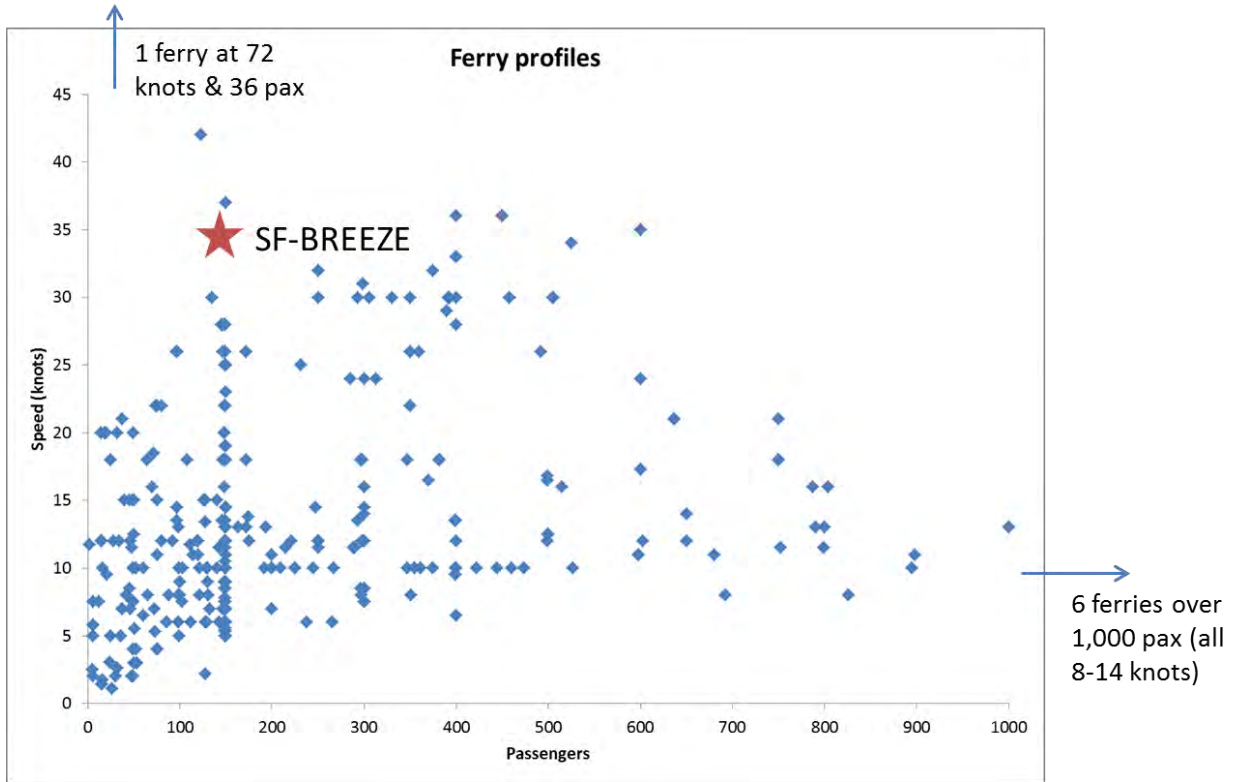

Figure 67: Speed/passenger profile of US passenger ferries in 2014. Data from Ref. [39] excluding vessels that did not report passenger count or speed.

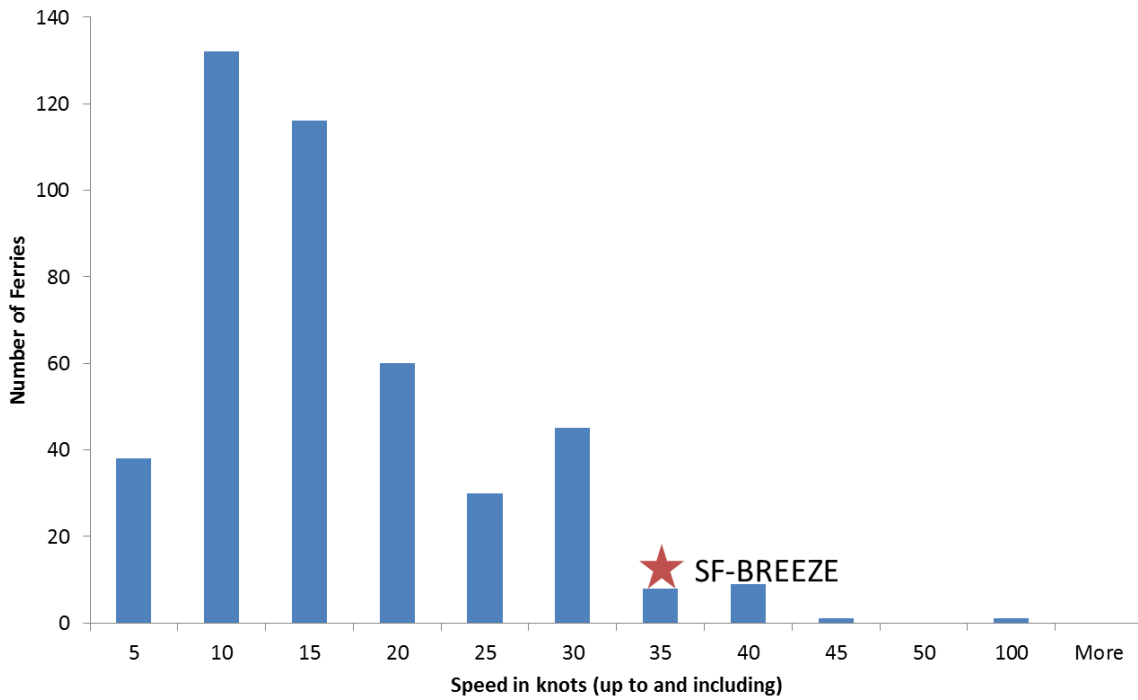

Figure 68: Speed profile of US passenger ferries in 2014. Data from Ref. [39], excluding non-powered barges and vessels with unreported speeds.

What both of these charts show is that there is clearly a business case for ferries that operate at much slower speeds than what the SF-BREEZE is designed for. While in the San Francisco Bay a 10 knot ferry would not be viable for the Vallejo-to-San Francisco Ferry Building route, there are several other routes that could be viable at these speeds, such as a cross-bay route between Oakland/Alameda and the Port of San Francisco. And clearly there are routes around the country where this is true as well.

This raises the general question: what is the optimal speed and passenger count of the SF-BREEZE that maximizes its advantage over diesel-fueled ferries? Is there a “sweet spot” in terms of speed and passenger count for hydrogen fuel cell ferry technology? Prior to detailed design and build, an optimization study should be conducted to examine the effect of these two factors on overall cost and per-passenger emissions, and in conjunction determine suitable alternate routes amenable to this different performance, in order to understand better the application space for this groundbreaking vessel.

It is possible that lowering the speed of the SF-BREEZE ferry would reduce its power requirement and its onboard hydrogen storage needs, triggering significant cost decreases in both capital and operating expense. At the same time, the vessel size could be modified to include more passengers, making the vessel more efficient on a per-passenger basis. This may allow improvement over existing diesel GHG emissions even with natural gas produced hydrogen.

6.1.2 Technical Topics for Future Study

1. Logistics, cost, and regulatory acceptance of fueling the SF-BREEZE with swappable LH₂ tanks rather than direct transfer of LH₂ via bunkering.
2. Vessel design and regulatory acceptance of utilizing high pressure (5,000 psi) hydrogen gas as the fuel including refueling after every one-way or round-trip.
3. Performance and cost impact of utilizing hydrogen internal combustion engines – both spark ignition reciprocating engines as well as hydrogen gas turbines, the latter being potentially more economically viable for high power applications such as the high speed ferry, albeit with some NO_x emissions if the exhaust is not treated.
4. Because fuel cells are amenable to distribution throughout the vessel, examination of alternative arrangements of the fuel cell stacks in order to increase passenger capacity. For example, installing a sub-floor under the passenger deck that can house the fuel cells can be examined from a vessel design perspective as well as a regulatory perspective.
5. Location of hydrogen storage below accommodation (passenger) spaces should be examined in detail to allow more design flexibility. This includes understanding the regulatory requirements in doing so and the technical and cost implications and effect on passenger capacity.
6. Examination of prismatic/conformable/membrane LH₂ storage tanks to enable easier location around the vessel. This may include examination of active cooling methods.
7. Examination of perceived/potential benefits of the zero emission hydrogen vessel (as discussed in Section 1.2).
8. Improvements to the hydrogen liquefaction process to reduce cost of the capital installations as well as decrease the energy intensity of the process. There is existing R&D in this area, but this study has highlighted another motivation for doing so. If zero emission hydrogen vessels

become more widespread, including larger cargo-type vessels, the need for cost effective LH₂ will become more critical.

9. Impact on well-to-waves emissions and fuel cost of hydrogen generated as a byproduct of industrial processes, such as chlorine production.

6.1.3 Regulatory Topics for Future Study

1. Marine-specific hydrogen flow characterization (gas dispersion analyses) to provide the technical basis behind potential exceptions to the current IGF Code requirements and/or hazardous zone reductions due to the differences in the properties of LNG and LH₂.
2. Development of sound hydrogen-specific regulations and rules to enable simpler approvals from regulatory agencies and class societies. This includes not only vessel and shore-side infrastructure design regulations but also training and emergency response guidance.
3. Examining the technical basis for not allowing non-hydrocarbon fuels (i.e. hydrogen) to be exempt from the OSHA PSM requirement.

6.1.4 Policy Recommendations

1. Recognizing the impact of marine transport on the environment, including marine transport applications as eligible in incentive and grant programs currently applicable only to land transport vehicles.
2. Institution of analogous Zero Emission Vehicle goals or mandates to the marine sector.
3. Providing preferred treatment of environmentally favorable technology in evaluation of marine projects for financial support. This could include additional incentives based on emissions reductions as well as preference during application evaluations.
4. Development of a strategy to develop a unique and robust zero emission vessel shipbuilding capability in the United States, including regulatory and/or financial encouragement of adoption of zero emission vessels into the US Merchant Marine.

6.1.5 Implementation Recommendations

This effort reached over 40 different organizations and interacted with more than 130 individuals. The authors found a striking difference in awareness of hydrogen and fuel cell technologies. Either people had a very good understanding of the technology and its potential – typically confined to those who already work in the field – or nearly no awareness at all about it. While there were some exceptions, the vast majority of people outside the hydrogen technology industry fell into the second category prior to interacting with the project team. As the project progressed, the core team found ourselves repeating the same thing after an interaction with a new stakeholder:

Nobody knows anything about hydrogen.

This is not an indictment on anyone who participated in the study. To a person, everyone we interacted with was technically savvy, extremely supportive and generous with their time and gave straightforward and helpful feedback. They also became very interested in learning more about the technology and by-and-large ended up being quite enthusiastic about its potential. We are in fact very humbled to be responsible for the first exposure to hydrogen and fuel cells for many of these people.

The point of highlighting this observation is to emphasize the incredible amount of effort needed at a very foundational level to garner widespread support for any such effort to introduce hydrogen and fuel cell technology into a new application such as marine vessels. A *very common* first reaction to hearing about the SF-BREEZE project was to ask how such a thing differs from (a) a hydrogen bomb or (b) the *Hindenburg* (and sometimes both).

The easiest way for the maritime industry to move forward with this concept in an effort to eliminate marine vessel emissions will be with widespread public education leading to support. Through this project we have found that, for the vast majority of people we interacted with, initial resistance is more rooted in a lack of awareness rather than opposition. A final recommendation is therefore to substantially improve public outreach activities about hydrogen and fuel cells. Conveniently for the maritime industry, the fuel cell vehicle industry has started this effort. That resource can be leveraged – for example, engaging maritime stakeholders in fuel cell vehicle “ride and drive” events and arranging for local organizations such as the California Fuel Cell Partnership to assist in community outreach.

7 References

- [1] "Third IMO GHG Study 2014: Executive Summary and Final Report, June 2014," International Maritime Organization, Marine Environment Protection Committee, MEPC 67/INF.32014.
- [2] "Resolution MEPC.203(62); Amendments to the annex of the protocol of 1997 to amend the international convention for the prevention of pollution from ships, 1973, as modified by the protocol of 1978 relating thereto," International Maritime Organization, Marine Environment Protection Committee, MEPC 62/24/Add.12011.
- [3] California Environmental Protection Agency Air Resources Board, "Almanac Emission Projection Data (published in 2013); 2012 Estimated Annual Average Emissions," California Environmental Protection Agency, 2013. Available: https://www.arb.ca.gov/app/emsinv/2013/emssumcat_query.php?F_YR=2012&F_DIV=-4&F_SEASON=A&SP=2013&F_AREA=CA, Accessed September 22, 2016.
- [4] H. N. Psaraftis and C. A. Kontovas, "CO2 emission statistics for the world commercial fleet," *WMU Journal of Maritime Affairs*, vol. 8, pp. 1-25, 2009.
- [5] J. J. Corbett and A. Farrell, "Mitigating air pollution impacts of passenger ferries," *Transportation Research Part D: Transport and Environment*, vol. 7, pp. 197-211, 2002.
- [6] California Environmental Protection Agency Air Resources Board, "Emissions Estimation Methodology for Commercial Harbor Craft Operating in California," California Environmental Protection Agency, 2007 (est.). Available: <https://www.arb.ca.gov/regact/2007/chc07/appb.pdf>, Accessed September 22, 2016.
- [7] Section 93118.5, title 17, chapter 1, subchapter 7.5, California Code of Regulations, "Airborne Toxic Control Measure for Commercial Harbor Craft," State of California.
- [8] *Control of Emissions of Air Pollution from New Marine Compression-Ignition Engines at or Above 37 kW*, United States Code of Federal Regulations Title 40, Part 94, 1999.
- [9] *Final Rule: Control of Emissions of Air Pollution from Locomotive and Marine Compression-Ignition Engines Less than 30 Liters Per Cylinder*, United States Code of Federal Regulations Title 40, Part 1042, 2008.
- [10] J. Keller, L. Klebanoff, S. Schoenung, and M. Gillie, "The Need for Hydrogen-based Energy Technologies in the 21st Century," in *Hydrogen Storage Technology, Materials and Applications*, L. E. Klebanoff, Ed., ed Boca Raton: Taylor & Francis, 2012, p. 3.
- [11] S. Solomon, D. Qin, M. Manning, Z. Chen, M. Marquis, K. B. Averyt, M. Tignor, and H. L. Miller, "Climate Change 2007: The Physical Science Basis. Contribution of Working Group I to the Fourth Assessment Report of the IPCC," Intergovernmental Panel on Climate Change (IPCC), Cambridge, U.K.
- [12] National Research Council of the National Academies, *America's Climate Choices, Panel on Advancing the Science of Climate Change*, 2010.
- [13] J. Graetz, D. J. Wolstenholme, G. P. Pez, L. E. Klebanoff, G. S. McGrady, and A. C. Cooper, "Development of Off-board Reversible Hydrogen Storage Materials," in *Hydrogen Storage Technology, Materials and Applications*, L. E. Klebanoff, Ed., ed Boca Raton: Taylor & Francis, 2012, p. 239.
- [14] L. Klebanoff, J. Keller, M. Fronk, and P. Scott, "Hydrogen Conversion Technologies and Automotive Applications," in *Hydrogen Storage Technology, Materials and Applications*, L. E. Klebanoff, Ed., ed Boca Raton: Taylor & Francis, 2012, p. 31.
- [15] V. P. McConnell, "Now, voyager? The increasing marine use of fuel cells," *Fuel Cells Bulletin*, vol. 2010, pp. 12-17, 2010.

- [16] FellowSHIP, "First true hybrid system to be installed on board an offshore supply vessel," 2012. Available: <http://vikinglady.no/2012/03/15/first-true-hybrid-system-to-be-installed-on-board-an-offshore-supply-vessel/>, Accessed Jun 21, 2013,
- [17] Siemens, "Italian navy orders two more submarines with Siemens fuel cell technology," 2009. Available: http://www.siemens.com/press/en/pressrelease/?press=/en/pressrelease/2009/industry_solutions/iis200910926.htm, Accessed Jun 21, 2013,
- [18] A. E. Hammerschmidt, "Fuel Cell Propulsion of Submarines," in *Advanced Naval Propulsion Symposium 2006*, Arlington, VA, 2006.
- [19] naval-technology.com, "U212 / U214 Submarines, Germany," 2012. Available: http://www.naval-technology.com/projects/type_212/, Accessed Jun 21, 2013,
- [20] "One hundred passengers and zero emission, The first ever passenger vessel to sail propelled by fuel cells," *Zemships*, 2008.
- [21] "Clean Machines - GL," Germanischer Lloyd SE. Available: <http://www.gl-group.com/en/13111.php>, Accessed May 24, 2016.
- [22] "German Fuel Cell Ferry Tallies Up 1,900 Hours of Service," *EV World*, 2012. Available: <http://evworld.com/news.cfm?newsid=29032>, Accessed May 24, 2016.
- [23] Personal communication with M. Lobmeyer, ATG (Alster-Touristik GmbH), September 8, 2016.
- [24] C. Hornby, "First fuel cell boat cruises Amsterdam's canals," *Reuters*, 2009. Available: <http://www.reuters.com/article/us-dutch-fuelcell-idUSTRE5B83HD20091209>, Accessed May 24, 2016.
- [25] L. Langfeldt, "Status of maritime Fuel Cell Technology," presented at the ICST, Hamburg, Germany, September 10, 2015.
- [26] Personal communication with R. Van Heek, Hybrid Power Systems (HYPS), September 6, 2016.
- [27] "Bristol Hydrogen Boats," 2016. Available: <http://www.bristolhydrogenboats.co.uk/about.html>, Accessed September 22, 2016.
- [28] "Hydrogenesis Passenger Ferry - Ship Technology," 2013. Available: <http://www.ship-technology.com/projects/hydrogenesis-passenger-ferry/>, Accessed September 22, 2016.
- [29] "First Hydrogen Fuel Cell Powered Ferry in UK Showcases Green Technology - Renewable Energy Focus," 2013. Available: <http://www.renewableenergyfocus.com/view/33545/first-hydrogen-fuel-cell-powered-ferry-in-uk-showcases-green-technology/>, Accessed September 22, 2016.
- [30] "Maritime Journal | Jas Singh: Auriga Energy," 2015. Available: <http://www.maritimejournal.com/news101/comment-and-analysis/jas-singh-aspiration-for-alternatives>, Accessed September 22, 2016.
- [31] "Passenger Vessel Ferry for sale, 12.00 m (39'4\"), 2013 | Boatshed Bristol," 2016. Available: http://bristol.boatshed.com/passenger_vessel_ferry-boat-222502.html, Accessed September 22, 2016.
- [32] "e4Ships - fuel cells in marine applications," *e4Ships*. Available: <http://www.e4ships.de/>, Accessed May 24, 2016.
- [33] K. B. Ludvigsen and E. Ovrum, "Fuel cells for ships; Research and Innovation, Position Paper 13-2012," *Det Norske Veritas (DNV)*, 2012.
- [34] Z. Karin, N. Leavitt, T. Costa, and R. Grijalva, "Marine Fuel Cell Market Analysis," *United States Coast Guard*, Report CG-D-01-001999.
- [35] C. Kennell, "Over-the-Horizon 'Green' Perspective," presented at the FAST 2015 Conference, September 3, 2015.
- [36] J. Sun, J. Stebe, and C. Kennell, "Fuel cells going on-board," *Naval Engineers Journal*, vol. 2010, pp. 87-102, 2011.

- [37] L. Cohen, A. Tate, and N. Weinhold, "Implications of the Integration of Fuel Cell Systems into Naval Vessels and Specific Application on USN T-AGOS 19 Class," Naval Surface Warfare Center Carderock Division, Report NSWCCD-80-TR-2014/0472014.
- [38] "First electrical car ferry in the world in operation in Norway now," Nuremberg, Germany: Siemens, 2015. Available: <http://www.siemens.com/press/PR2015050200PDEN>, Accessed May 24, 2016.
- [39] U.S. Department of Transportation Office of the Assistant Secretary's (OST-R's) Bureau of Transportation Statistics, "Bureau of Transportation Statistics, National Census of Ferry Operators," U.S. Department of Transportation, 2014. Available: https://www.rita.dot.gov/bts/sites/rita.dot.gov/bts/files/subject_areas/ncfo/index.html, Accessed November 11, 2015.
- [40] J. Larminie and A. Dicks, *Fuel cell systems explained*, 2nd ed. Hoboken, NJ: John Wiley & Sons, Inc., 2003.
- [41] A. E. Lutz, R. S. Larson, and J. O. Keller, "Thermodynamic comparison of fuel cells to the Carnot cycle," *International Journal of Hydrogen Energy*, vol. 27, pp. 1103-1111, 2002.
- [42] S. E. Wright, "Comparison of the theoretical performance potential of fuel cells and heat engines," *Renewable Energy*, vol. 29, pp. 179-195, 2004.
- [43] "ES-5700 Fuel Cell Data Sheet," Bloomenergy, 2016. Available: <http://www.bloomenergy.com/fuel-cell/es-5700-data-sheet/>, Accessed May 24, 2016.
- [44] "DFC300 (300 Kilowatt kW)," FuelCell Energy, 2013. Available: <http://www.fuelcellenergy.com/products-services/products/300-kw-dfc300/>, Accessed May 24, 2016.
- [45] "PureCell Model 400 Fuel Cell System," Doosan Fuel Cell America Inc., 2014. Available: http://www.doosanfuelcell.com/attach_files/link/PureCell%20Model%20400%20Datashet.pdf,
- [46] Personal communication with T. Patterson, Doosan, 2016.
- [47] K. Kuroda, presented at the 4th IPHE Workshop-Stationary Fuel Cells, Tokyo, Japan, March 1, 2011.
- [48] M. Hasegawa and Y. Horiuchi, *Fuji Electric Review*, vol. 56, p. 140.
- [49] Personal communication with R. Sookhoo, Director New Initiatives at Hydrogenics, 2015-2016.
- [50] "HyPM-HD Power Modules for light to heavy duty mobility," Hydrogenics, 2015. Available: <http://www.hydrogenics.com/docs/default-source/default-document-library/hypm-hd-8pg-jan2015-lr.pdf?sfvrsn=0>,
- [51] C. San Marchi, B. P. Somerday, and S. L. Robinson, "Permeability, Solubility and Diffusivity of Hydrogen Isotopes in Stainless Steels at High Gas Pressures," *International Journal of Hydrogen Energy*, vol. 32, pp. 100-116, 2007.
- [52] L. E. Klebanoff, Ed., *Hydrogen Storage Technology, Materials and Applications*. Boca Raton: Taylor & Francis, 2012.
- [53] C. Ahn and J. Purewal, "Storage Materials Based on Hydrogen Physisorption," in *Hydrogen Storage Technology, Materials and Applications*, L. E. Klebanoff, Ed., ed Boca Raton: Taylor & Francis, 2012, p. 213.
- [54] L. E. Klebanoff and J. O. Keller, "5 Years of Hydrogen Storage Research in the U.S. DOE Metal Hydride Center of Excellence (MHCoe)," *International Journal of Hydrogen Energy*, vol. 38, pp. 4533-4576, 2013.
- [55] V. Stavila, L. E. Klebanoff, J. J. Vajo, and P. Chen, "Development of On-board Reversible Complex Metal Hydrides for Hydrogen Storage," in *Hydrogen Storage Technology, Materials and Applications*, L. E. Klebanoff, Ed., ed Boca Raton: Taylor & Francis, 2012, p. 133.

- [56] B. Chao and L. E. Klebanoff, "Hydrogen Storage in Interstitial Metal Hydrides," in *Hydrogen Storage Technology, Materials and Applications*, L. E. Klebanoff, Ed., ed Boca Raton: Taylor & Francis, 2012, p. 109.
- [57] Personal communication with B. Chao, 2015-2016.
- [58] R. C. Bowman and L. E. Klebanoff, "Historical Perspectives on Hydrogen, its Storage and Applications," in *Hydrogen Storage Technology, Materials and Applications*, L. E. Klebanoff, Ed., ed Boca Raton: Taylor & Francis, 2012, p. 65.
- [59] Personal communication with J. Mullen, Gardner Cryogenics, 2015-2016.
- [60] Personal communication with J. P. Smith, Linde Group, 2015-2016.
- [61] Personal communication with K. McKeown, Linde Group, 2015-2016.
- [62] Personal communication with D. Farese, Air Products and Chemicals, Inc., 2015-2016.
- [63] "Operating Instructions Diesel Engine 16 V 4000 E20," MTU Friedrichshafen GmbH, 2011. Available: https://www.mtu-online.com/fileadmin/fm-dam/mtu-global/technical-info/operating-instructions/neu_17_08_2012/en/M015241_03E.pdf,
- [64] R. Edwards, J.-F. Larive, V. Mahieu, and P. Rouveiolles, "Well-to-Wheels Analysis of Future Automotive Fuels and Powertrains in the European Context: Well-to-Tank Report, Version 2C," Joint Research Center of the European Commission, 2007.
- [65] R. Edwards, J.-F. Larive, D. Rickeard, and W. Weindorf, "Well-to-Wheels Analysis of Future Automotive Fuels and Powertrains in the European Context: Well-to-Tank Report, Version 4," Joint Research Center of the European Commission, 2013.
- [66] California Energy Commission, "Utility Annual Power Content Labels for 2014," State of California, 2016. Available: <http://www.energy.ca.gov/pcl/labels/index.html>, Accessed May 24, 2016.
- [67] P. S. Mehta and K. Anand, "Estimation of a Lower Heating Value of Vegetable Oil and Biodiesel Fuel," *Energy and Fuels*, vol. 23, pp. 3893-3898, 2009.
- [68] G. Knothe, "Biodiesel and renewable diesel: A comparison," *Progress in Energy and Combustion Science*, vol. 36, pp. 364-373, 2010.
- [69] S. Unnasch and J. Pont, "Full Fuel Cycle Assessment Well to Tank Energy Inputs, Emissions, and Water Impacts," TIAX, LLC, for the California Energy Commission, CEC-600-2007-002-D, 2007.
- [70] D. A. Cooper, K. Peterson, and D. Simpson, "Hydrocarbon, PAH and PCB emissions from ferries: A case study in the Skagerak-Kattegatt-Öresund region," *Atmospheric Environment*, vol. 30, pp. 2463-2473, 1996/07/01 1996.
- [71] D. A. Cooper and K. Andreasson, "Predictive NOx emission monitoring on board a passenger ferry," *Atmospheric Environment*, vol. 33, pp. 4637-4650, 1999.
- [72] D. A. Cooper, "Exhaust emissions from high speed passenger ferries," *Atmospheric Environment*, vol. 35, pp. 4189-4200, 2001.
- [73] J. Nuskowski, N. N. Clark, T. K. Spencer, D. K. Carder, M. Gautam, T. H. Balon, and P. J. Moynihan, "Atmospheric Emissions from a Passenger Ferry with Selective Catalytic Reduction," *Journal of the Air & Waste Management Association*, vol. 59, pp. 18-30, 2009/01/01 2009.
- [74] J. Hord, "Is Hydrogen a Safe Fuel?," *International Journal of Hydrogen Energy*, vol. 3, pp. 157-176, 1978.
- [75] T. D. Donakowski, "Is Liquid Hydrogen Safer Than Liquid Methane?," *Fire Technology*, vol. 17, pp. 183-188, 1981.
- [76] G. D. Brewer, "An Assessment of the Safety of Hydrogen-Fueled Aircraft," *Journal of Aircraft*, vol. 20, pp. 935-939, 1983.
- [77] G. D. Brewer, *Hydrogen Aircraft Technology*. Boca Raton: CRC Press, 1991.
- [78] "Final Report On An Investigation of Hazards Associated with the Storage and Handling of Liquid Hydrogen," A.D. Little, Inc. Report to the U.S. Air Force, C-610921960.

- [79] L. H. Cassutt, F. E. Maddocks, and W. A. Sawyer, "A Study of the Hazards in Storage and Handling of Liquid Hydrogen," Report to the U.S. Air Force, Report No. 61-05-51821964.
- [80] "An Assessment of the Crash Fire Hazard of Liquid Hydrogen Fueled Aircraft," A.D. Little, Inc. Final Report to the National Aeronautics and Space Administration, NASA CR-165526 1982.
- [81] A. Contreras, S. Yigit, K. Ozay, and T. N. Veziroglu, "Hydrogen as Aviation Fuel: A Comparison with Hydrocarbon Fuels," *International Journal of Hydrogen Energy*, vol. 22, pp. 1053-1060, 1997.
- [82] G. A. Karim, "Some Considerations of the Safety of Methane, (CNG), as an Automotive Fuel-Comparison with Gasoline, Propane and Hydrogen Operation," SAE Technical Paper Series 8302671983.
- [83] M. Hajbabaie, G. Karavalakis, K. C. Johnson, L. Lee, and T. D. Durbin, "Impact of Natural Gas Fuel Composition on Criteria, Toxic and Particle Emissions from Transit Buses Equipped with Lean Burn and Stoichiometric Engines," *Energy*, vol. 62, pp. 425-434, 2013.
- [84] J. D. Naber, D. L. Siebers, S. S. DiJulio, and C. K. Westbrook, "Effects of Natural Gas Composition on Ignition Delay Under Diesel Conditions," *Combustion and Flame*, vol. 99, pp. 192-200, 1994.
- [85] S. Bates and D. S. Morrison, "Modelling the Behavior of Stratified Liquid Natural Gas in Storage Tanks: A Study of the Rollover Phenomenon," *International Journal of Heat and Mass Transfer*, vol. 40, pp. 1875-1884, 1997.
- [86] "NIST Standard Reference Database 69: NIST Chemistry WebBook," U.S. Secretary of Commerce on behalf of the United States of America, 2016. Available: <http://webbook.nist.gov/chemistry/>, Accessed May 24, 2016.
- [87] G. Wedler and M. Mengel, "The Adsorption of Methane on Polycrystalline Iron Films," *Surface Science*, vol. 131, pp. L423-L428, 1983.
- [88] D. C. Sorescu, "First-principles Calculations of the Adsorption and Hydrogenation Reactions of CH_x (x = 0, 4) Species on a Fe(100) Surface," *Physics Reviews B*, vol. 73, p. 155420, 2006.
- [89] A. Staykov, J. Yamabe, and B. P. Somerday, "Effect of Hydrogen Gas Impurities on the Hydrogen Dissociation on Iron Surface," *Int. J. Quantum Chemistry* vol. 114, pp. 626-635, 2014.
- [90] F. Bozso, G. Ertl, M. Grunze, and M. Weiss, "Chemisorption of Hydrogen on Iron Surfaces," *Applied Surface Science*, vol. 1, pp. 103-119, 1977.
- [91] R. P. Gangloff and B. P. Somerday, Eds., *Gaseous Hydrogen Embrittlement of Materials in Energy Technologies* vol. 1. Cambridge: Woodhead Publishing Ltd., 2012.
- [92] R. P. Gangloff and B. P. Somerday, Eds., *Gaseous Hydrogen Embrittlement of Materials in Energy Technologies* vol. 2. Cambridge: Woodhead Publishing Ltd., 2012.
- [93] R. D. Witcofski and J. E. Chirivella, "Experimental and Analytical Analyses of the Mechanisms Governing the Dispersion of Flammable Clouds Formed by Liquid Hydrogen Spills," *International Journal of Hydrogen Energy*, vol. 9, pp. 425-435, 1984.
- [94] K. Verfondern and B. Dienhart, "Pool Spreading and Vaporization of Liquid Hydrogen," *International Journal of Hydrogen Energy*, vol. 32, pp. 2106 – 2117, 2007.
- [95] K. Verfondern and B. Dienhart, "Experimental and Theoretical Investigations of Liquid Hydrogen Pool Spreading and Vaporization," *International Journal of Hydrogen Energy*, vol. 22, pp. 649-660, 1997.
- [96] R. E. Reed-Hill and R. Abbaschian, *Physical Metallurgy Principles*. Boston, MA: PWS Publishing, 1994.
- [97] M. G. Zabetakis, *Safety with Cryogenic Fluids*. New York, NY: Plenum, 1967.
- [98] P. Middha, M. Ichard, and B. J. Arntzen, "Validation of CFD Modelling of LH₂ Spread and Evaporation Against Large-scale Spill Experiments," *International Journal of Hydrogen Energy*, vol. 36, pp. 2620-2627, 2011.

- [99] L. M. Das, "Hydrogen Engines: A View of the Past and a Look Into the Future," *International Journal of Hydrogen Energy*, vol. 15, pp. 425-443, 1990.
- [100] F. L. Dryer, M. Chaos, Z. Zhao, J. N. Stein, J. Y. Alpert, and C. J. Homer, "Spontaneous Ignition of Pressurized Releases of Hydrogen and Natural Gas into Air," *Combust. Sci. and Tech.*, vol. 179, pp. 663-694, 2007.
- [101] G. R. Astbury and S. J. Haworth, "Spontaneous Ignition of Hydrogen Leaks: A Review of Postulated Mechanisms," *International Journal of Hydrogen Energy*, vol. 32, pp. 2178-2185, 2007.
- [102] T. Mogi, Y. Wada, Y. Ogata, and A. K. Hayashi, "Self-ignition and Flame Propagation of High-pressure Hydrogen Jet During Sudden Discharge from a Pipe," *International Journal of Hydrogen Energy*, vol. 34, pp. 5810-5816, 2009.
- [103] K. L. Cashdollar, I. A. Zlochower, G. M. Green, R. A. Thomas, and M. Hertzberg, "Flammability of Methane, Propane and Hydrogen Gases," *Journal of Loss Prevention in the Process Industries* vol. 13, pp. 327-340, 2000.
- [104] R. W. Schefer, G. H. Evans, J. Zhang, A. J. Ruggles, and R. Greif, "Ignitability Limits for Combustion of Unintended Hydrogen Releases: Experimental and Theoretical Results," *International Journal of Hydrogen Energy*, vol. 36, pp. 2426-2435, 2011.
- [105] H. D. Ng and J. H. S. Lee, "Comments on Explosion Problems for Hydrogen Safety," *Journal of Loss Prevention in the Process Industries* vol. 21, pp. 136-146, 2008.
- [106] A. Luketa and T. Blanchat, "The Phoenix Series Large Scale Methane Gas Burner Experiments and Liquid Methane Pool Fire Experiments on Water," *Combustion and Flame*, vol. 162, pp. 4497-4513, 2015.
- [107] H. Matsui and J. H. Lee, "On the Measure of the Relative Detonation Hazards of Gaseous Fuel-Oxygen and Air Mixtures," *Symposium (International) on Combustion*, vol. 17, pp. 1269-1280, 1979.
- [108] J. M. Yang, "An Improved Analytical Approach to Determine the Explosive Effects of Flammable Gas-Air Mixtures," Lawrence Livermore National Laboratory Report UCRL-TR-2170052005.
- [109] R. Knystautas, C. Guirao, J. H. Lee, and A. Sulmistras, "Measurements of Cell Size in Hydrocarbon-Air Mixtures and Predictions of Critical Tube Diameter, Critical Initiation Energy and Detonability Limits," *Progress in Astronautics and Aeronautics*, vol. 94, 1984.
- [110] M. P. Sherman, S. R. Tieszen, and W. B. Benedick, "FLAME Facility: The Effect of Obstacles and Transverse Venting on Flame Acceleration and Transition to Detonation for Hydrogen-Air Mixtures at Large Scale," Sandia National Laboratories Report SAND85-1264 R31989.
- [111] S. B. Dorofeev, V. P. Sidorov, A. E. Dvoinishnikov, and W. Breitung, "Deflagration to Detonation Transition in Large Confined Volume of Lean Hydrogen-Air Mixtures," *Combustion and Flame*, vol. 104, pp. 95-110, 1996.
- [112] M. Groethe, E. Merilo, J. Colton, S. Chiba, Y. Sato, and H. Iwabuchi, "Large-scale Hydrogen Deflagrations and Detonations," *International Journal of Hydrogen Energy*, vol. 32, pp. 2125-2133, 2007.
- [113] P. Middha and O. R. Hansen, "Predicting Deflagration to Detonation Transition in Hydrogen Explosions," *Process Safety Progress*, vol. 27, pp. 192 -204, 2008.
- [114] D. A. Kessler, V. N. Gamezo, and E. S. Oran, "Simulations of Flame Acceleration and Deflagration-to-Detonation Transitions in Methane-Air Systems," *Combustion and Flame*, vol. 157, pp. 2063-2077, 2010.
- [115] C. T. Johansen and G. Ciccarelli, "Visualization of Unburned Gas Flow Field Ahead of An Accelerating Flame in an Obstructed Square Channel," *Combustion and Flame*, vol. 156, pp. 405-416, 2009.

- [116] C. J. Gerritsma and J. H. Haanstra, "Infrared Transmission of Air Under Laboratory Conditions," *International Journal of Hydrogen Energy*, vol. 10, pp. 79-90, 1970.
- [117] A. Luketa, "Recommendations on the Prediction of Thermal Hazard Distances from Large Liquefied Natural Gas Pool Fires on Water for Solid Flame Models," Sandia National Laboratories Report SAND2011-94152011.
- [118] J. A. Fay, "Model of Large Pool Fires," *J. Hazardous Materials* vol. B136, pp. 219-232, 2006.
- [119] P. K. Raj, "Large Hydrocarbon Pool Fires: Physical Characteristics and Thermal Emission Variations with Height," *J. Hazardous Materials* vol. 140, pp. 280-292, 2007.
- [120] A. Luketa-Hanlin, "A Review of Large-scale LNG Spills: Experiments and Modeling," *J. Hazardous Materials* vol. A132, pp. 119-140, 2006.
- [121] D. W. Hissong, "Keys to Modeling LNG Spills on Water," *J. Hazardous Materials* vol. 140, pp. 465-477, 2007.
- [122] V. Babrauskas, "Estimating Large Pool Fire Burning Rates," *Fire Technology*, vol. 19, pp. 251 – 261, 1983.
- [123] C. Vargel, "Chapter 9: Fire resistance of aluminium. In: Aluminium and the Sea," ALCAN Aerospace Transportation and Industry, available at: <http://www.ansatt.hig.no/henningj/materialteknologi/lvd-aluminium%20and%20the%20sea.htm2004>.
- [124] C.-D. Wen and I. Mudawar, "Emissivity Characteristics of Roughened Aluminum Alloy Surfaces and Assessment of Multispectral Radiation Thermometry (MRT) Emissivity Models," *International Journal of Heat and Mass Transfer*, vol. 47, pp. 3591-3605, 2004.
- [125] "Liquid Hydrogen--the Fuel of Choice for Space Exploration," National Aeronautics and Space Administration, 2010. Available: http://www.nasa.gov/topics/technology/hydrogen/hydrogen_fuel_of_choice.html, Accessed May 24, 2016.
- [126] Personal communication with J. Fesmire, NASA Cryotest Lab, Kennedy Space Center, 2016.
- [127] M. Hightower, L. Gritzko, A. Luketa-Hanlin, J. Covan, S. Tieszen, G. Wellman, M. Irwin, M. Kaneshige, B. Melof, C. Morrow, and D. Ragland, "Guidance on Risk Analysis and Safety Implications of a Large Liquefied Natural Gas (LNG) Spill Over Water," Sandia National Laboratories Report: SAND2004-62582004.
- [128] Personal communication with A. Harris and B. Oesterreich, Air Liquide, 2015.
- [129] Personal communication with B. O'Neil, D. Farese, B. Bonner, and E. Kiczek, Air Products and Chemicals, Inc., 2015-2016.
- [130] Personal communication with N. Natesan and K. McKeown, Linde LLC, 2015-2016.
- [131] Personal communication with L. Moser, M. Wattanapanom, R. Han, and R. Craighead, Praxair, 2016.
- [132] Personal communication with M. Robbins, San Francisco Bay Ferry, 2015-2016.
- [133] Personal communication with R. Berman, J. Davey, and A. Golbus, Port of San Francisco, January 7 and 15, 2016.
- [134] Personal communication with R. Berman, M. Lozovoy, J. Davey, E. Kim, U. Prasad, K. Cofflin, and T. Carter, Port of San Francisco, November 24, 2015.
- [135] "Port Owned Property," Port of San Francisco, 2016. Available: http://www.sfport.com/sites/default/files/FileCenter/Documents/7775-posf_land_allsf.pdf, Accessed May 24, 2016.
- [136] S. A. Duncan, "Rapid Structural Assessment Report, Pier 54 Substructure," Port of San Francisco, 2013.

- [137] J. K. Dineen, "Warriors arena to be named Chase Center — bank buys naming rights," Hearst Communications, 2016. Available: <http://www.sfgate.com/bayarea/article/Warriors-arena-to-be-named-Chase-Center-bank-6788844.php>, Accessed May 24, 2016.
- [138] "The City from the Valley," Stamen Design, 2015. Available: <https://hi.stamen.com/the-city-from-the-valley-57e835ee3dc6#.x41b7n2q5>, Accessed May 24, 2016.
- [139] M. Quinn, "The shuttle effect, and the commute that divides us," San Jose Mercury News, 2014. Available: http://www.mercurynews.com/michelle-quinn/ci_27078188/quinn-commute-that-divides-us, Accessed May 24, 2016.
- [140] J. Pratt, D. Terlip, C. Ainscough, J. Kurtz, and A. Elgowainy, "H2FIRST Reference Station Design Task Project Deliverable 2-2," Sandia National Laboratories and National Renewable Energy Laboratory, Sandia Report SAND2015-2660 R, 2015.
- [141] U.S. Energy Information Administration (EIA), "The Impact of Increased Use of Hydrogen on Petroleum Consumption and Carbon Dioxide Emissions," U.S. Department of Energy, 2008. Available: <http://www.eia.gov/oiaf/servicerpt/hydro/appendixc.html>, Accessed May 24, 2016.
- [142] U. S. D. o. Energy, "Hydrogen Production," U.S. Department of Energy. Available: <https://www.hydrogen.energy.gov/production.html>, Accessed May 24, 2016.
- [143] G. Saur and A. Milbrandt, "Renewable Hydrogen Potential from Biogas in the United States," National Renewable Energy Laboratory, Technical Report NREL/TP-5400-60283, 2014.
- [144] S. Krasae-in, J. H. Stang, and P. Neksa, "Development of large-scale hydrogen liquefaction processes from 1898 to 2009," *International Journal of Hydrogen Energy*, vol. 35, pp. 4524-4533, 2010.
- [145] C. E. G. Padró and V. Putsche, "Survey of the Economics of Hydrogen Technologies," National Renewable Energy Laboratory, Technical Report NREL/TP-570-27079, 1999.
- [146] "Bunkering of Liquefied Natural Gas-fueled Marine Vessels in North America, 2nd Edition," American Bureau of Shipping, 2015 (assumed).
- [147] Occupational Safety and Health Administration, "Process Safety Management," U.S. Department of Labor, 2000. Available: <https://www.osha.gov/Publications/osha3132.html>, Accessed May 24, 2016.
- [148] T. Galassi, "02/04/2013 - Clarification of the term "hydrocarbon" as used in the PSM standard," U.S. Department of Labor, Occupational Safety & Health Administration, 2013. Available: https://www.osha.gov/pls/oshaweb/owadisp.show_document?p_table=INTERPRETATIONS&p_id=29000, Accessed May 24, 2016.
- [149] Personal communication with K. Smith, US Coast Guard, January 21, 2016.
- [150] M. Kay, M. Dyer, D. Mannheim, K. Miller, and K. Sylvester, "Ferry Lifecycle Cost Model for Federal Land Management Agencies," U.S. Department of Transportation, Research and Innovative Technology Administration, John A. Volpe National Transportation Systems Center, Report NSWCCD-80-TR-2014/0472011.
- [151] J. Marcinkoski, J. Spendelow, A. Wilson, and D. Papageorgopoulos, "Fuel Cell System Cost - 2015," US Department of Energy, DOE Hydrogen and Fuel Cells Program Record 15015, 2015.
- [152] R. T. Madsen, "144-Car Ferry LNG Fuel Conversion Feasibility Study, Design Report," The Glostén Associates File No. 11030.01, 2011.
- [153] "Appendix 5 LNG Terminal Cost Data and Calculations," in *North European LNG Infrastructure Project, A feasibility study for an LNG filling station infrastructure and test of recommendations*, ed: The Danish Maritime Authority, 2012.
- [154] "Appendix 8 Overall Bunker Technology," in *North European LNG Infrastructure Project, A feasibility study for an LNG filling station infrastructure and test of recommendations*, ed: The Danish Maritime Authority, 2012.

- [155] *North European LNG Infrastructure Project. A feasibility study for an LNG filling station infrastructure and test of recommendations.* Copenhagen: The Danish Maritime Authority, 2012.
- [156] "WETA Breaks Ground on North Bay Operations and Maintenance Facility Mare Island, May 15, 2014," Water Emergency Transit Authority, 2014.
- [157] M. D. Paster, R. K. Ahluwalia, G. Berry, A. Elgowainy, S. Lasher, K. McKenney, and M. Gardiner, "Hydrogen storage technology options for fuel cell vehicles: Well-to-wheel costs, energy efficiencies, and greenhouse gas emissions," *International Journal of Hydrogen Energy*, vol. 36, pp. 14534-14551, 2011.
- [158] "Find out how your business may be able save energy and money with renewable biogas and biomethane," Southern California Gas Company, 2016. Available: <https://www.socalgas.com/for-your-business/power-generation/biogas-biomethane>, Accessed May 24, 2016.
- [159] U.S. Energy Information Administration (EIA), "California Natural Gas Prices," U.S. Department of Energy, 2016. Available: https://www.eia.gov/dnav/ng/NG_PRI_SUM_DCU_SCA_A.htm, Accessed May 24, 2016.
- [160] Z. Zhang and G. Braun, "Cost of Electricity & Pipeline Quality Natural Gas from Biogas," presented at the 24th Annual BioCycle West Coast Conference 2008, San Diego, CA, April 14 -16, 2008.
- [161] "Electric and Gas Utility Cost Report. Public Utilities Code Section 913 Report to the Governor and Legislature," California Public Utilities Commission, 2016.
- [162] "Notice of Proposed Award, Alternative and Renewable Fuel and Vehicle Technology Program, Grant Solicitation PON-13-607, Hydrogen Refueling Infrastructure," California Energy Commission, 2014.
- [163] F. Caiazzo, A. Ashok, I. A. Waitz, S. H. L. Yim, and S. R. H. Barrett, "Air pollution and early deaths in the United States. Part I: Quantifying the impact of major sectors in 2005," *Atmospheric Environment*, vol. 79, pp. 198-208, 2013.
- [164] "Regulatory Impact Analysis (RIA) for the final Transport Rule Docket ID No. EPA-HQ-OAR-2009-0491. Regulatory Impact Analysis for the Federal Implementation Plans to Reduce Interstate Transport of Fine Particulate Matter and Ozone in 27 States; Correction of SIP Approvals for 22 States," U.S. Environmental Protection Agency Office of Air and Radiation, 2011.
- [165] R. H. B. Steven, L. S. Raymond, D. E. Sebastian, C. D. Irene, A. Akshay, M. Robert, and W. K. David, "Impact of the Volkswagen emissions control defeat device on US public health," *Environmental Research Letters*, vol. 10, p. 114005, 2015.
- [166] "Technical Support Document - Estimating the Benefit per Ton of Reducing PM2.5 Precursors from 17 Sectors," U.S. Environmental Protection Agency, Research Triangle Park, NC, 2013.
- [167] "Funding Sources," Bay Area Air Quality Management District, 2015. Available: <http://www.baaqmd.gov/grant-funding/funding-sources>, Accessed May 24, 2016.
- [168] "Ports' Technology Advancement Program," Clean Air Action Plan, 2016. Available: <http://www.cleanairactionplan.org/technology-advancement-program/>, Accessed May 24, 2016.

Appendix A
Elliott Bay Design Group Design Package



SF-BREEZE FERRY FEASIBILITY STUDY

Design Study Report

Prepared for: Sandia National Laboratories • Livermore, CA

Ref: 15051-001-070-2

Rev. -

February 12, 2016

PREPARED BY

Elliott Bay Design Group
5305 Shilshole Ave. NW, Ste. 100
Seattle, WA 98107

GENERAL NOTES

1. The vessel described in this report has been designed to a "Feasibility Study" level. This level of detail is only intended to confirm that it is possible to build a vessel to the basic requirements which are described in this report. Therefore, specific components described within should not be considered selected, as such, and a more detailed design may contain significant changes.

REVISIONS

REV	DESCRIPTION	DATE	APPROVED
P0	Preliminary issue	11/16/2015	KTS
P1	Preliminary issue	1/21/2016	KTS
-	Initial Issue	2/12/2016	KTS 48364

TABLE OF CONTENTS

	PAGE
1 Introduction	1
2 Performance Requirements	1
2.1 Basic Requirements	1
2.1.1 Service and Speed	1
2.1.2 Endurance	2
2.1.3 Maneuvering	2
2.1.4 Passenger Complement	2
2.1.5 Tonnage	2
2.1.6 Environmental Impact	2
2.1.7 EPA	3
2.1.8 CARB Requirements	3
2.2 Operating Envelope	3
2.3 Bunkering Operations	3
3 Vessel	3
3.1 Hull	3
3.1.1 Hullform Selection	3
3.1.2 Structure	4
3.1.3 Hydrodynamics	4
3.1.4 Lifting Devices	4
3.2 Arrangements	4
3.2.1 Hold	4
3.2.2 Main Deck	5
3.2.3 Upper Deck	5
4 Systems	5
4.1 Power	5
4.1.1 Hydrogen Fuel Cells	5
4.1.2 Electrical Systems	6
4.1.3 Motors	6
4.1.4 Gears	6
4.2 Propulsors	7
4.2.1 Waterjets	7
4.2.2 Voith Linear Jets	7
4.3 Hydrogen Fuel Supply	8
4.3.1 Liquid Hydrogen Tank	8
4.3.2 Vaporizers	8
4.3.3 Venting	8
4.3.4 Piping Materials	9
4.4 Cooling	9
4.5 Control and Monitoring	9
4.5.1 Normal Operation	9
4.5.2 Emergency Operation	9
4.6 Maneuvering / Responsiveness	9

4.7	Ride Quality	9
4.8	Fire Protection	9
4.8.1	Structural Fire Protection	10
4.8.2	Water Spray System	10
4.9	Automation and Emergency Power	10
4.10	Accommodations	10
4.10.1	Water and Waste	10
4.10.2	Passenger Cabin	11
4.10.3	Snack Bar	11
4.11	Maintenance	11
5	Regulations	11
5.1	Regulatory Matrix / Gap Analysis	11
5.2	Hazardous Zones	12
5.3	Structural Fire Protection	13
5.4	Hydrogen Piping	14
6	Comparison to Conventional Diesel	14
6.1	Emissions	14
6.1.1	EPA Requirements	14
6.2	Estimate of Carbon Emissions	15
6.2.1	Carbon per Kilowatt	15
6.2.2	Propulsive Efficiency	15
7	Future Work	15
7.1.1	Fuel Cell Racks	15
7.1.2	Hull Design	16
7.1.3	System Design	16
8	References	17
Appendix A		
Appendix B		
Regulatory Gap Analysis		

1 INTRODUCTION

This design study report describes the feasibility of the design and acquisition of a 109 ft x 33 ft x 11.25 ft high speed catamaran passenger vessel which is powered by hydrogen fuel cells. The total height of the vessel (air draft) above the waterline is approximately 38.25 ft. The vessel's name is the SF-BREEZE which stands for San Francisco Bay Renewable Energy Electric vessel with Zero Emissions.

As there are currently no hydrogen powered vessels of this kind in commercial service in the United States, this vessel is a novel concept with many unique design and regulatory challenges. First and foremost, hydrogen fuel cells are significantly heavier than an equivalently rated internal combustion engine. Because of this, more power must be installed to make speed than with traditional diesel powered vessels. This is especially true for a high speed vessel, which depends on dynamic lift generated at high speeds to reduce resistance. More lift is needed to overcome the extra weight.

Secondly, hydrogen fuel is volatile and must be contained in such a way as to mitigate the risk of accidental combustion. Though hydrogen is more volatile than other fuel types already in use, it can be demonstrated that in some ways its volatility actually reduces the risk or severity of combustion or explosion. Briefly, its propensity to evaporate and dissipate quickly may mean that a hydrogen fuel spill or leak will not be able to accumulate to the levels required to produce a flammable mixture, and thus, have a lower ignition risk than, say, natural gas (methane). Sandia National Laboratories has performed extensive analysis to demonstrate that regulations intended to apply to liquefied natural gas (LNG) systems are generally acceptable for application to hydrogen systems because of the similarities between the two fuel types.

Finally, hydrogen fuel cells produce direct current (DC) power with voltage that is variable with load. This is an uncommon vector for propulsive power on commercial vessels. Conversion of this power into alternating current (AC) for the motors requires a relatively complex configuration of converters, AC inverters, and other power conditioning equipment as compared to other ships with electrically powered propulsors.

2 PERFORMANCE REQUIREMENTS

2.1 Basic Requirements

2.1.1 Service and Speed

In order for the design to be commercially viable, the vessel must be able to complete commuter routes in San Francisco Bay in an equal or lesser amount of time as existing high speed ferries. This means being able to complete transit from downtown San Francisco to either the North Bay (Vallejo) or the South Bay (e.g. Redwood City) in about an hour's time. In order to do this, the vessel must be able to cruise at 33-35 knots.

Table 1 shows a representative route profile from Vallejo to downtown San Francisco Pier 1 or 2. This route is currently serviced by several high speed catamarans with diesel power plants. These vessels, particularly the M/V VALLEJO, were used for baseline estimates and comparisons in this study.

Table 1: Route Profile

	Passenger Loading	Maneuvering - Vallejo F.T.	Mare Island Channel	Full Speed	Maneuvering - Pier 1/2	Passenger Unloading
Distance (nm)	0	0.1	2	21.65	0.25	0
Total Distance Traveled (nm)	0	0.1	2.1	23.75	24	24
Speed (knots)	0	5	10	35	5	0
Step Duration (min)	5	1.2	12	37.1	3	5
Cumulative Time (min)	5	6.2	18.2	55.3	58.3	63.3
%MCR	0	10	25	92	10	0
Propulsion Power (MW)	0	0.47	1.18	4.4	0.47	0
Ship Service Power (MW)	0.12	0.12	0.12	0.12	0.12	0.12
Total Power (MW)	0.12	0.59	1.30	4.52	0.59	0.12

12

2.1.2 Endurance

The vessel must be able to complete two round trips between downtown San Francisco and Vallejo in the North Bay, or to an undetermined location in the South Bay, before refueling. This is approximately 100 miles in total.

2.1.3 Maneuvering

The vessel will be required to use the same passenger loading facilities as existing diesel catamarans, therefore, the vessel must be capable of an equivalent ability to maneuver as these vessels as it approaches a dock.

2.1.4 Passenger Complement

The passenger complement is 150. This is the maximum allowed for vessels inspected under 46 Code of Federal Regulations (CFR) Subchapter T, Small Passenger Vessels.

2.1.5 Tonnage

As a Subchapter T boat, the Gross Register Tonnage (GRT) is limited to 100. Calculations [1] show that the vessel meets this requirement.

2.1.6 Environmental Impact

The vessel utilizes proton exchange membrane (PEM) fuel cells in which the electrochemical reaction is $2\text{H}_2 + \text{O}_2 = \text{H}_2\text{O}$. As a result, the vessel produces water and no other emissions when generating power. Similarly, if hydrogen liquid or gas is leaked and catches fire, the only resulting product is pure water. If a hydrogen leak occurs and the gas escapes, this also does not produce harmful emissions as hydrogen gas is non-toxic and is not a greenhouse gas. Also, it is

¹ The powering requirements indicated on this table are for the hydrogen fuel cell ferry, which are higher than the powering requirements for diesels operating on the same route. The increased power requirement is mostly due to the increased weight of the relatively heavier hydrogen power plant. Route parameters are based on a route currently serviced by the M/V VALLEJO.

² Power value given is the un-margined power (power required to make speed). Installed power is 4.92 MW.

not possible to contaminate water with hydrogen as the hydrogen will immediately evaporate upon contact with the water with no effect on the marine ecosystem.

High speed vessels have the potential to generate a large wake which could lead to shoreline erosion. This is particularly problematic in the South Bay where the water is shallower and breaking wave height is increased. Existing ferries in the Bay have undergone analyses to determine their impact and have been shown to be acceptable, but it is important to consider this for the subject vessel in later design stages. It is possible that since it is a relatively heavier vessel that the wake properties could be worse than similar vessels that are lighter.

The vessel has a large heat rejection value which is mainly from the fuel cells themselves, but also includes DC-DC converters, DC-AC inverters, propulsion motors, and accommodation heating, ventilation, and air conditioning (HVAC). The cooling water leaving the vessel should be considered as a possible source of environmental impact. It is important to note that equivalent diesel powered vessels also have significant heat rejection values. It is anticipated that the cooling water discharge temperature for the SF-BREEZE will be equivalent to that of existing diesel boats in operation since the fuel cells operate at relatively low temperatures.

2.1.7 EPA

The US Environmental Protection Agency emissions and vessel general permit requirements will be met in full. See Section 6.1.1 for a discussion of how the emissions regulations are currently applied to diesel engines.

2.1.8 CARB Requirements

The California Air Resources Board (CARB) has marine pollution requirements that will be met in full. The two specific sections that pertain to harbor craft emissions are 13 CA ADC 2299.5 and 17 CA ADC 93118.5.

2.2 Operating Envelope

The vessel will operate entirely within the boundaries of San Francisco Bay. As such, the vessel will be designed to a stability standard which meets the requirements of partially protected waters.

2.3 Bunkering Operations

Bunkering operations for the ferry will be very similar to bunkering liquefied natural gas fuelled vessels. A preliminary bunkering procedure has been developed (Reference [2]).

3 VESSEL

3.1 Hull

3.1.1 Hullform Selection

The vessel is designed as a high speed catamaran with a planing hullform. This was selected as the best overall option in the EBDG Qualitative Hull Comparison [3]. The catamaran hullform was selected over the monohull because of reduced powering requirements, improved stability,

and greater available space. It was selected over a trimaran hullform because of reduced construction cost and improved maneuverability.

3.1.2 Structure

All hull structure is aluminum. As a weight-sensitive high speed vessel, aluminum is superior to steel. Further weight reduction could be realized by using a fiber reinforced plastic construction (FRP), but construction cost would be higher.

Aluminum also has superior properties to steel when exposed to extreme cold temperatures. Steel becomes brittle at cryogenic temperatures and may be damaged, while aluminum does not have increased brittleness or reduction in yield strength.

3.1.3 Hydrodynamics

The vessel is designed as a planing hull. The target cruising speed is 35 knots, which yields a length Froude Number of about 1.0 and a volume Froude Number of 2.9. This indicates that the vessel is well within the speed range considered planing. The Blount/Fox M factor, or "hump" factor is about 1.18, which is relatively small (compared to 1.74 at 26 knots) and demonstrates that the vessel is mostly above the "hump" on the speed vs. resistance curve, which is also indicative that the vessel is in the planing region.

The longitudinal center of gravity (LCG) must be considered when performing resistance and propulsion calculations. As much of the machinery is located at the aft end of the vessel, the LCG has a negative effect on top speed. This can be countered with careful weight control, control of the distribution of the buoyant volume, or by use of a lifting device.

3.1.4 Lifting Devices

An effective way to reduce the running trim angle or increase lift on the hull (both of which tend to increase speed by reducing drag) is by use of a lifting device.

The simplest type of lifting device is a wedge. A wedge is simply a fixed wedge-shaped surface installed on the bottom of the hull near the stern which slightly deflects water flowing along the bottom of the vessel downward, and generates a small amount of lift. Other types of devices include trim tabs, interceptors, and tunnel foils, all of which produce a similar effect on the trim and lift of the vessel.

The particular design of the lifting device requires a more detailed hydrodynamic analysis to optimize the performance and determine its effectiveness. Therefore, no estimated effect was included in this analysis. High speed vessels can attain a 10% reduction in resistance by effective use of a lifting device and it is likely that one will be incorporated into the design if the project moves forward. [4]

3.2 **Arrangements**

3.2.1 Hold

The hold is arranged in five port and starboard compartments. The aftermost compartment is the steering gear/waterjet compartment, followed by the motor/gear compartment, equipment room,

void, and finally the forepeak. Bulkheads between these compartments are watertight and have minimal piping or ducting penetrations. The three aftermost compartments are ventilated.

The vessel is designed to a 1-compartment damage stability standard as required by US Coast Guard (USCG). This means that any single compartment (in both demihulls simultaneously) can be damaged and the vessel will maintain a waterline that does not reach the edge of the main deck.

3.2.2 Main Deck

The main deck consists of an aft exterior area, the fuel cell rooms, the control room, and the passenger cabin. The passenger cabin contains seating for 150, an Americans with Disabilities Act (ADA) compliant restroom, and a snack bar.

3.2.3 Upper Deck

The upper deck consists of the liquefied hydrogen tank and hydrogen vaporizers in an exterior location, and the pilothouse.

4 SYSTEMS

4.1 Power

4.1.1 Hydrogen Fuel Cells

Total installed power is 4.92 MW. Of this power, 4.4 MW is required for propulsion, 120 kW is estimated for other systems, and the remainder is kept as a margin.

PEM fuel cells are installed in two port and starboard spaces which are separated by a bulkhead in order to meet the intent of Reference [5]. Redundancy in the fuel cells allows the vessel to continue to maneuver and travel at a reduced speed in the case of loss of the fuel cells in one of the spaces. Each of these spaces is ventilated with fans mounted on the aft bulkhead which include demisters and filters to remove moisture, salt, and particulate matter from the air supply. Cooling water is supplied from piping routed upwards from the hold heat exchangers through the control room and aft to the fuel cell rooms. Vaporized hydrogen fuel is supplied to the fuel cells through the vaporizers on the upper deck.

Fuel cells are mounted in racks of 4 x 30 kW units. Each 120 kW rack has a single cooling water supply and return pipe, a single hydrogen supply line, a blower for air delivery, an exhaust duct, and a drain for water which is the product of the chemical reaction.

Currently, 40 racks of 120 kW fuel cells are shown in the General Arrangement [6] which only provide 4.8 kW of power. Each rack contains 4x30 kW fuel cells, and it is assumed that through further optimization of the fuel cell rack construction (e.g. 5x30 kW Fuel Cells per rack rather than 4x30 kW) that the additional power will be able to be installed in the available space in the fuel cell rooms.

4.1.2 Electrical Systems

The fuel cells are equally divided into two spaces, one each on port and starboard sides, each of which has its own set of redundant electrical conversion equipment to provide power to the propulsors.

The DC power supplied by the fuel cells has variable voltage between no-load and full load, and must be conditioned by use of a DC-DC converter in order to provide uniform power to the AC inverter. The conditioned DC power is supplied to a common bus so both propulsors may be run off of half of the fuel cells if one of the fuel cell rooms became unavailable.

It is assumed that a line filter is needed on each DC supply side to protect the fuel cells from ripple current. Other filters may be necessary in other parts of the system to further mitigate current harmonics or ripple currents.

Batteries are used to supply power during voltage sags at motor startup, and to provide general stability to the electrical system. While there is not enough battery power to run propulsion systems, the batteries will be able to run navigation and emergency systems for a couple of hours.

For redundancy, a pair of inverters and transformers will supply power for other ship service loads, like cooling pumps, steering gear, lighting, navigation electronics, and HVAC equipment.

4.1.3 Motors

Shaft power is generated with AC permanent magnet motors. Permanent magnet motors were selected because of their high power to weight ratio compared with standard AC induction motors. Each shaft may have either a single 2 MW motor or two 1 MW motors in tandem on a single shaft. The larger 2 MW motors were initially selection because their RPM range is compatible with the water jet propulsors, which allows reduction gears to be eliminated.

The physical size and weight of the motors is dependent on their rated power and RPM. When selecting a motor, two options are possible. If a small, high RPM motor is selected, motor weight is reduced, however, a reduction gear will probably be required to match the propulsor RPM. If a motor is selected which matches the propulsor RPM, then the motor must be physically larger (and heavier per unit power generated) in order to generate the torque required to deliver enough power at the slower RPM. A large motor directly driving a waterjet without a gear would likely be significantly cheaper than using multiple small motors with a reduction gear installed.

DC motors were considered, however, they appear to be an inferior choice because DC motors of this size are generally much heavier than equivalently sized AC motors (especially AC permanent magnet motors), and AC motors are slightly more efficient.

4.1.4 Gears

Currently, it is assumed that reduction gears would not be necessary because the RPM of the waterjet and that of the larger electric motor are relatively close. If the final selection of

propulsor and motor do not end up having matching RPM ranges, then reduction gears may be necessary.

If two motors are used per hull on a tandem shaft, it may be necessary to use a V-reduction gear because of space constraints. The compartment may not be long enough to align a gear and two motors on the same shaft.

4.2 Propulsors

Two different propulsion options are considered for this feasibility study, a standard waterjet and the Voith Linear Jet. Both are attractive alternatives for different reasons, and their respective strengths and weaknesses are described.

4.2.1 Waterjets

Waterjets are the typical propulsor selected for high speed catamarans. They are more efficient than propellers at high speeds, reduce vibration noise, and reduce appendage drag as steering is accomplished using maneuvering buckets (rather than rudders) which are outside of the flow at cruising speed and, therefore, contribute no additional drag. They also allow design of a simpler streamlined hull because a waterjet is designed to mate with a relatively flat bottom shell surface, which may improve hull efficiency and reduce construction costs. Installation inside of the hull envelope also greatly reduces the chance of a damaging strike with floating debris. Waterjets have a high enough RPM that it may be possible to select a motor that can drive the waterjet without a gear, saving weight and reducing mechanical losses.

As compared to the Voith Linear Jet (VLJ), the disadvantage of the waterjet is that it may have a slightly lower propulsive efficiency, meaning that more power may be required to make speed.

4.2.2 Voith Linear Jets

The Voith Linear Jet is a ducted propeller with a leading stator assembly that reduces swirl. It is designed to be highly efficient at 30-35 knots. Preliminary estimates suggest that this propulsor may be more efficient overall than waterjets, and therefore, increase vessel top speed.

The Voith Linear Jet extends down below the vessel baseline, so there is danger of striking debris such as a floating log. The VLJ also does not provide steering capability as a waterjet does, so rudders must be installed. The VLJ runs at a lower RPM than similarly sized, waterjets. A motor with the same power rating but a lower rpm would have a greater torque rating. For a given motor power an increase in torque/decrease in RPM is proportional to a larger physical size and weight for the motor. Therefore, it may be possible to use the VLJ without a reduction gear, but the motor may need to be very large (heavy) to produce the required torque at a lower RPM.

Finally, the VLJ is a relatively new propulsor type with few existing installations. Lack of operational data as compared with waterjets may make this a riskier selection. The cost of the VLJ and other associated costs at this point are unknown. Final selection would be dependent on the cost along with the technical considerations described above.

4.3 Hydrogen Fuel Supply

4.3.1 Liquid Hydrogen Tank

Hydrogen is stored in liquid form (LH₂) in a 1200 kg capacity Type C tank on the upper deck near midship. Section 6.3.1 of the IGF Code states that natural gas in a liquid state may be stored with a maximum allowable relief valve setting of up to 1.0 MPa (145 psi) however it has yet to be determined if this pressure limitation will be acceptable for this application based on the required hydrogen pressure for the fuel cells. A higher relief valve setting and working pressure may be required and allowed because the LH₂ tank is above deck and relatively small. Based on the representative route profile described in section 2.1.1, the required hydrogen fuel consumption was calculated to be approximately 1000 kg for two round trips. The remainder left in the tank (tail/heel) is intentional, and is used to keep the tank at cryogenic temperatures in between refuelings, and for operational margin. The vessel is intended to make four round trips per day during commute hours, so bunkering will take place during a mid-day period and at night after operations are completed.

The level of liquid hydrogen in the LH₂ tank will be monitored by use of a differential pressure gauge on the tank. It is important to note that in existing LH₂ tank systems temperature is typically not measured.

The LH₂ tank includes integrated pressure building / vaporization equipment to ensure adequate supply pressure to the fuel cells when in use. The pressure building component is known as a "pressure build coil". This component takes heat from the ambient air to passively warm liquid hydrogen into a vapor in order to keep the contents of the tank at a suitable pressure for delivery of the contents to the vaporizers without use of a pump.

During bunkering of LNG, an event known as "rollover" may occur, which is a rapid mixing and exchange of heat between two different compositions of the fuel which may cause pressure spikes and a blowout of the storage tank. Based on conversations with industry experts, it has been determined that due to the purity of liquid hydrogen fuel, that rollover is not a concern.

4.3.2 Vaporizers

Immediately aft of the LH₂ tank are vaporizers which are needed to supply the fuel cells with vaporized hydrogen at the correct pressure and temperature. Since the current vessel concept only has as single fuel source, it is necessary to provide redundancy in the fuel delivery system when following the intent of Reference [7]. Each fuel supply system consists of a vaporizer, isolation valves, monitoring equipment, and a pressure regulating valve. The heat for the vaporizers may come from waste heat from the fuel cell cooling water loop.

4.3.3 Venting

The tank overpressure vent is placed near midship, directly over the vaporizers. This is to keep the H₂ source away from the mast lighting and electronics. If mast lighting and electronics are selected which are explosion proof, it may be allowable to move the vent onto the mast or reposition it as desired. It has been shown that if the LH₂ tank vent opens, the hydrogen will quickly warm up in the vent duct and by the time it reaches the outlet will be sufficiently buoyant so as to proceed straight up into the atmosphere and away from the vessel.

4.3.4 Piping Materials

Piping materials and requirements are described in Reference [8]. The material requirements specified in this reference are for suitable for liquid hydrogen.

4.4 **Cooling**

The major heat load on the vessel is the hydrogen fuel cells. Assuming a net fuel cell efficiency of 40%, and that the full 4.92 MW is utilized, the maximum heat rejection is 7.38 MW.

Freshwater/seawater heat exchangers for the fuel cell cooling loop will be located in the hold. The fuel cell cooling loop will be routed through the control room and aft to manifolds in the fuel cell rooms to distribute cooling water to the fuel cells. This cooling water may also be used to vaporize the LH₂ in the vaporizers.

Separate sea water heat exchangers will be used for the remaining systems.

4.5 **Control and Monitoring**

4.5.1 Normal Operation

Control of propulsion will be performed from the pilothouse. The fuel cells are load following, so no independent control of the fuel cells from the pilothouse is necessary.

Monitoring equipment for the individual fuel cells will be located locally in the fuel cell rooms and remotely in the control room.

Fuel system alarm and monitoring and firefighting shall follow the guidance of Reference [7]. Navigation, communications, lifesaving, firefighting, and stability shall follow USCG Subchapter T [9].

4.5.2 Emergency Operation

During the event of a partial fuel cell failure (one of the fuel cell compartments becomes unavailable) propulsion will still be available using both motors at reduced power. It is not feasible to provide enough battery power to drive the motors for a significant length of time.

4.6 **Maneuvering / Responsiveness**

The response time of the fuel cells from standby (zero power) to full power is 5-10 seconds. When the fuel cells are at low power, the response time to full power is less than 1 second. This is superior to the response time of diesel engines.

4.7 **Ride Quality**

As compared with a diesel-driven vessel, the fuel cell powered vessel will likely produce less noise and vibrations. Electric motors are much quieter than internal combustion engines. In addition, there is no odor from either the hydrogen fuel or the fuel cell exhaust.

4.8 **Fire Protection**

Adopted fire safety requirements are prescribed under Section 11 of Reference [7].

4.8.1 Structural Fire Protection

Boundaries facing LNG fuel tanks on open decks are required to have A-60 structural fire protection per Reference [7]. Due to the properties of LH₂ fuel, A-60 structural fire protection may be unnecessary to preserve the structural integrity of aluminum when subjected to an LH₂ fire. Sandia National Laboratories has performed analysis that demonstrates that due to a combination of the reduced cooling caused by the LH₂ during a spill, and the buoyancy of the vaporized hydrogen, that very little heat is transferred into the deck below during a spill/ignition event to cause a significant rise in the temperature of the aluminum deck.

If fiber reinforced plastic or another composite material were used instead of aluminum, an analysis would need to be performed to determine how well it could withstand a fire.

4.8.2 Water Spray System

A water spray system will be installed on the upper deck to cover the fuel tank in case of fire. Exposed areas of fuel storage tanks and adjacent areas are required to be protected.

4.9 Automation and Emergency Power

Unattended machinery spaces shall be protected with Emergency Shutdown (ESD) of non-safe equipment (ignition sources) in the case of a detected gas leak. If gas reaches unsafe levels, a gas detector will trigger the shutdown of the fuel supply and all ignition sources (aside from ventilation fans) in the compartment in which the leak is detected while still allowing the fuel cells in the second compartment to operate.

Redundant AC inverters for ship's power are provided to satisfy emergency power requirements per 183.310 of Reference [9].

Other automated systems include:

- DC and AC power control
- H₂ supply
- Fuel cell shutdown
- Battery management
- Cooling system monitoring and regulating
- HVAC

4.10 Accommodations

4.10.1 Water and Waste

Passengers have access to a single ADA compliant restroom and a snack bar. Assuming that 10% of passengers per day (150 passengers x 8 trips x 10% = 120 uses) use a low flow toilet and sink (1.6 gallons per flush, plus 0.3 gallons per sink use), then 228 gallons will be needed to operate the restroom facilities per day. The vessel will have a 300 gallon water tank, which leaves an additional 72 gallons for other uses (such as a sink at the snack bar, if installed). The vessel will also have a sewage holding tank with a marine sanitation device.

4.10.2 Passenger Cabin

The passenger cabin has seating for 150 passengers and will have the required number of ADA compliant seating options.

4.10.3 Snack Bar

The snack bar will be able to serve hot food and beverages. A coffee maker and a microwave may be installed, but no other food preparation will be available.

4.11 Maintenance

Maintenance of fuel cells in a marine environment should take special consideration as the fuel cells are very sensitive to corrosion from salt air. The ventilation system includes demisters and filters to mitigate that concern, but special care should be taken when the vessel is first put into service to confirm that salt air is not impinging on the fuel cell hardware.

5 REGULATIONS

As a passenger ferry operating in US waters, 46 CFR Subchapter T – Small Passenger Vessels applies in full. The remaining documents are used as guidance, as no official regulations yet exist which specifically apply to a hydrogen powered, high speed, aluminum ferry. The design will be submitted to the USCG for review and will also be submitted to ABS for an "Approval in Principle" but will not be classed.

The following regulations have been considered in the design of the subject vessel:

1. 46 CFR Subchapter T – Small Passenger Vessels [9]
2. IMO MSC 95/22/Add.1 (Adopted IGF Code) [7]
3. IMO CCC 2/3/1 (IGF Code with Fuel Cell Additions) [5]
4. ABS Guide for Propulsion and Auxiliary Systems for Gas Fueled Ships [10]
5. ABS Rules for Building and Classing High-Speed Craft [11]
6. IEC 60092-502 Electrical Installations on Ships [12]
7. IEC 60079-10 Electrical Apparatus for Explosive Gas Atmospheres [13]
8. 46 CFR Subchapter J – Electrical Engineering [14]
9. 46 CFR Subchapter F – Marine Engineering [15]
10. ASME B31.12 Hydrogen Piping and Pipelines [8]
11. ANSI/CSA America FC1-2004 Stationary Fuel Cell Power Systems [16]
12. IEC 62282-2 Fuel Cell Technologies - Part 2: Fuel Cell Modules [17]
13. IEC 62282-3 Fuel Cell Technologies - Part 3-100: Stationary Fuel Cell Power Systems - Safety [18]
14. IEC 60068-2-6 Environmental Testing – Part 2-6: Tests – Test Fc: Vibration (Sinusoidal) [19]

5.1 Regulatory Matrix / Gap Analysis

See Appendix B for a matrix describing applicability of the various regulations listed above. The matrix provides a gap analysis, meaning that it describes which regulations apply, and to what extent the current design complies with them. In general, the regulations that apply to the various systems are as described below:

- Arrangement and Hazardous Zones – Subchapter T, IGF code, IEC
- Structure – ABS Rules for Building and Classing High-Speed Craft
- Propulsion (excluding fuel cells) – Subchapters T and J
- LH₂ system (tank, fuel cells, piping) – IGF code, ASME B31.12, ANSI/CSA FC 1-2004, IEC 62282-2, IEC 62282-3, IEC 60068-2-6
- Electrical system (lighting, power, etc.) – Subchapter J, IGF Code, IEC 60079-10-1, IEC 60092-502

There are a few specific elements to the vessel design that are not in compliance with the adopted IGF Code [7]. These elements are described below along with a proposed method of alternative compliance.

5.2 Hazardous Zones

Hazardous Zone designations are defined according to Reference [7]. The locations of all ventilation inlets, outlets, openings to non-hazardous zones, and non-explosion proof equipment are outside of hazardous zones as required except as listed below. See Appendix A for the Hazardous Zones drawing.

IGF Code Paragraph 13.3.5

"Air inlets for hazardous enclosed spaces shall be taken from areas that, in the absence of the considered inlet, would be non-hazardous. Air inlets for non-hazardous enclosed spaces shall be taken from non-hazardous areas at least 1.5 m away from the boundaries of any hazardous area. Where the inlet duct passes through a more hazardous space, the duct shall be gas-tight and have over-pressure relative to this space."

All air inlets are located outside of hazardous zones as described in section 12.5 of the IGF code, however, the ventilation openings to the port and starboard lazarette and steering gear rooms are approximately .5 meters from the zone 2 boundary created by the fuel cell rooms and do not currently meet 13.3.5. It is not practical to remove the air inlets to these spaces from the 1.5m proximity to the fuel cell room hazardous zones. The ventilation openings to these spaces face aft in an attempt to minimize the likelihood that hazardous hydrogen gas could enter the space. Furthermore, due to the buoyancy of the hydrogen gas, it is unlikely that a leak could cause significant amounts of hydrogen to enter the spaces through the air inlets.

Additionally, the entrance and air inlets to the fuel cell rooms on the main deck are within the hazardous zone from the spillage coaming surrounding the vaporizer on the upper deck. The current design renders it impractical to remove the openings to the fuel cell rooms from the hazardous zones caused by the vaporizer. It will be possible to demonstrate that there is a very low possibility and associated risk of a vaporizer leak entering the fuel cell room due to the buoyancy of hydrogen gas. A hydrogen gas leak from the upper deck would rise into the atmosphere, not sink to the main deck. Similarly, a liquid hydrogen spill would evaporate before it would become large enough to reach the main deck

IGF Code Paragraph 6.7.2.8

"The outlet from the pressure relief valves shall normally be located at least 10 m from the nearest:

- .1 air intake, air outlet or opening to accommodation, service and control spaces, or other non-hazardous area; and
- .2 exhaust outlet from machinery installations."

The air inlets and outlets to the fuel cell rooms do not currently meet this requirement.

The National Fire Protection Association (NFPA) 2 Hydrogen Technologies Code refers to the Compressed Gas Association (CGA) 5-5, which may be a suitable criterion that requires only a 10 foot vertical clearance above grade, or, 2 feet above adjacent equipment, or at a height sufficient to avoid vapor clouds for discharges of cold vapor. Alternatively, a gas dispersion analysis can be performed at a later stage of the design in order to demonstrate equivalency with this specific IGF requirement and reduce the offset distance to less than 10 meters. The vent is currently placed over 15 feet above any other structure, so this criterion is met.

5.3 Structural Fire Protection

Structural Fire Protection requirements are given in Reference [7]. Where practicable, these guidelines are met, with the following exceptions.

IGF Code Paragraph 11.3.2

"Any boundary of accommodation spaces, service spaces, control stations, escape routes and machinery spaces, facing fuel tanks on open deck, shall be shielded by A-60 class divisions. The A-60 class divisions shall extend up to the underside of the deck of the navigation bridge, and any boundaries above that, including navigation bridge windows, shall have A-0 class divisions. In addition, fuel tanks shall be segregated from cargo in accordance with the requirements of the International Maritime Dangerous Goods (IMDG) Code where the fuel tanks are regarded as bulk packaging. For the purposes of the stowage and segregation requirements of the IMDG Code, a fuel tank on the open deck shall be considered a class 2.1 package."

IGF Code Paragraph 11.3.6

"The bunkering station shall be separated by A-60 class divisions towards machinery spaces of category A, accommodation, control stations and high fire risk spaces, except for spaces such as tanks, voids, auxiliary machinery spaces of little or no fire risk, sanitary and similar spaces where the insulation standard may be reduced to class A-0."

Sandia National Laboratories has performed an analysis on the properties of a large release of liquid hydrogen, subsequent ignition, and its effects on an aluminum deck of nominal thickness [17]. They were able to demonstrate that due to the relatively low net heat transfer and short duration of such an event that it is safe to utilize bare aluminum or a less substantial fire boundary type and maintain the deck structural integrity. Therefore, it is intended to use deck

plate of a minimum thickness needed for structural requirement and not provide any additional mitigating coverings.

5.4 Hydrogen Piping

The IGF code gives regulations for piping materials to only a minimum design temperature of minus 165°C. The boiling point of hydrogen is minus 253°C, so piping containing liquid hydrogen will have design temperatures below the boiling point. Therefore, this design will utilize ASME Code B31.12 Hydrogen Piping and Pipelines which contains piping design, service, and fabrication requirements for piping in gaseous and liquid hydrogen service to a minimum temperature of minus 269°C.

6 COMPARISON TO CONVENTIONAL DIESEL

6.1 Emissions

Regulatory agencies that affect emissions requirements for this application are the U.S. Environmental Protection Agency (EPA), the National Oceanic and Air Administration (NOAA), and the California Air Resources Board (CARB). Local Bay Area organizations, port authorities, and other jurisdictions may also have regulations, goals, and/or incentives to reduce marine emissions and environmental impacts.

As stated in section 2.1.6, the hydrogen fuel cell power plant produces no emissions at the point of use, although CO₂ emissions are associated with hydrogen production from steam methane reformation. A diesel power plant produces a significant amount of Carbon Dioxide (CO₂), and other atmospheric pollutants.

6.1.1 EPA Requirements

Beginning in 2016, EPA Tier 4 requirements are fully in effect for marine diesel engines in the size needed for this vessel. Table 2 describes the maximum emissions allowed for Particulate Matter (PM), Nitrogen Oxides (NO_x), and Hydrocarbons (HC) for Tier 4 Diesel Engines. For reference, the number of kW-hrs per day for the subject vessel is about 25,000 kW-hrs. An equivalent diesel ferry, with its lesser power requirements due to less weight, is about 16,400 kW-hrs per day. Values given below are maximum allowable amounts and may be less depending on specific engine type and after treatment technology used. However, these values can be used for general comparison purposes.

Table 2: Tier 4 Engine Emission Limits - 40CFR 1042.101

TABLE 3 TO §1042.101—TIER 4 STANDARDS FOR CATEGORY 2 AND COMMERCIAL CATEGORY 1 ENGINES ABOVE 600 kW

Maximum engine power	Displacement (L/cyl)	Model year	PM (g/kW-hr)	NO _x (g/kW-hr)	HC (g/kW-hr)
600 ≤kW <1400	all	2017 +	0.04	1.8	0.19
1400 ≤kW <2000	all	2016 +	0.04	1.8	0.19
2000 ≤kW <3700 ^a	all	2014 +	0.04	1.8	0.19
kW ≥3700	disp. <15.0	2014-2015	0.12	1.8	0.19
	15.0 ≤disp.<30.0	2014-2015	0.25	1.8	0.19
	all	2016 +	0.06	1.8	0.19

CO₂ is not currently regulated under EPA requirements. EPA provides an estimate of brake specific fuel consumption (bsfc) for diesel engines for use in estimating CO₂ emissions. For medium speed diesels, this is 210 g/kW-hr [18]. Also provided is the CO₂ emission per gallon of Diesel burned, which is 22.9 lb/gal [19].

6.2 Estimate of Carbon Emissions

6.2.1 Carbon per Kilowatt

For internal combustion engines, the on-board carbon footprint is equal to that generated through diesel fuel production processes, delivery of the fuel, and combustion products when the engine is running. For hydrogen PEM fuel cells, the total carbon footprint is that associated with hydrogen production and delivery only, since the fuel cell itself produces zero emissions.

6.2.2 Propulsive Efficiency

The Overall Propulsive Coefficient (OPC) of the vessel is an important consideration when comparing characteristics of the vessel such as speed, operating cost, and carbon footprint. The OPC is defined as the power output of the vessel (speed times vessel weight) divided by the power produced at the motor shaft.

For the subject vessel, the two differences between the OPC of a diesel or LNG powered vessel and a LH₂ powered vessel are due to electrical conversion losses and increased weight of the LH₂ vessel. Both of these reduce the OPC for the SF-BREEZE as compared with the internal combustion options.

The following table lists the estimated OPC's for the 4 powering options. The values are based on the calculated powering requirement for the subject vessel at 33 knots vs. the installed power on the M/V VALLEJO, which also typically makes 33 knots.

Table 3: OPC compared to Diesel

Propulsion Option	% OPC compared to Diesel
Diesel	100%
LNG	100%
Steam-Reformed Hydrogen from Nat. Gas or Electrolysis Hydrogen (Renewable Energy)	84%

7 FUTURE WORK

7.1.1 Fuel Cell Racks

Hydrogenics, the manufacturer of the fuel cell model used in this study, has designed a fuel cell rack which consists of 4 x 30kW fuel cells with common cooling, ventilating, and control equipment. Because the design requires a large quantity of these racks, it may be feasible to design a fuel cell rack which is more space efficient, or to combine large quantities of fuel cells onto common racks. If vertical clearance allows, it may be possible to design racks with 5 or 6 fuel cells per rack. This would reduce the fuel cell footprint on the main deck and reduce the weight by minimizing cooling and ventilating equipment.

Paralleling additional fuel cells in this way will increase the DC voltage supplied, which may require different selections for DC-DC inverter components, but the overall system would probably be relatively unchanged.

7.1.2 Hull Design

The vessel hull design was done to a level of detail that demonstrates that such a vessel could be designed that meets the basic requirements. A complete design of the vessel hullform requires a more detailed analysis of the weights, dimensions, and ultimate planing performance. It may be possible, especially since the vessel is of a novel design with an unusual weight distribution, that the hullform ultimately will have properties that differ from a typical high speed catamaran designed to carry 150 passengers at 35 knots.

For example, the LCG of the vessel is a bit further aft than a typical high speed catamaran of these proportions would be. That may mean that the planing surface or buoyant volume of the hull may need to be shifted aft to support this weight. It's unclear what effect this would have on vessel resistance without further analysis.

Lifting devices, which are mentioned in section 3.1.4, also need further design. A lifting device was not used in this analysis, however, they are increasingly common in use for vessels of this type and may provide up to a 10% reduction in resistance. A lifting device may also be an essential means of producing a counteracting force to balance the weight moment.

Foil assisted lift is another interesting and possibly beneficial feature that can be designed for high speed catamarans. It is another type of lifting device which, instead of just reducing drag by minimizing running trim, may also simply lift the vessel further out of the water. This reduces wetted surface and drag. More analysis is needed to assess their potential effectiveness.

7.1.3 System Design

For this study, components of each system were verified to be commercially available which would satisfy the basic requirements. The details of these systems have not been designed. In particular, the conversion of fuel cell supplied DC power into conditioned AC power for the propulsion motors is complex and relatively unique with challenges that should not be taken for granted. Additionally, details of the fuel delivery system, alarm and monitoring system, and cooling systems all need to be developed to a further level of detail.

8 REFERENCES

- [1] Elliott Bay Design Group, "Tonnage Calculations," 15051-01M, Seattle, WA, February, 2016.
- [2] Elliott Bay Design Group, "Bunkering Procedure," 15051-001-062-1, Rev -, Seattle, WA, February 12, 2016.
- [3] Elliott Bay Design Group, "Qualitative Hull Comparison," 15051-001-070-1, Rev -, Seattle, WA, October 13, 2015.
- [4] D. C. C. W. L. Gabor Karafiath, "Stern Wedges and Stern Flaps for Improved Powering - U.S. Navy Experience," *SNAME Transactions*, vol. 107, pp. 67-99, 1999.
- [5] IMO Sub-Committee on Carriage of Cargoes and Containers, "Amendments to the IGF Code and Development of Guidelines for Low-Flashpoint Fuels," International Maritime Organization, 12 June 2015.
- [6] Elliott Bay Design Group, "General Arrangement," 15051-001-101-1, Rev -, Seattle, WA, February 12, 2016.
- [7] IMO Maritime Safety Committee, "Adoption of the International Code of Safety for Ships Using Gases or Other Low-Flashpoint Fuels (IGF Code)," International Maritime Organization, 11 June 2015.
- [8] American Society of Mechanical Engineers (ASME), "B31.12 Hydrogen Piping and Pipelines," 2014.
- [9] US Code of Federal Regulations, "46 CFR Subchapter T (Parts 175-187)".
- [10] American Bureau of Shipping, "Guide for Propulsion and Auxiliary Systems for Gas Fueled Ships," American Bureau of Shipping, Houston, TX, 2015.
- [11] American Bureau of Shipping, Rules for Building and Classing High-Speed Craft, Houston, TX: Amereican Bureau of Shipping, 2015.
- [12] International Electrotechnical Commission, "IEC 60092-502 Electrical Installations in Ships - Part 502: Tankers - Special Features," 1999.
- [13] International Electrotechnical Commission, "IEC 60079-10 Electrical apparatus for explosive gas atmospheres - Part 10: Classification of hazardous areas," 2002.
- [14] US Code of Federal Regulations, "46 CFR Subchapter J - Electrical Engineering".

- [15] US Code of Federal Regulations, "46 CFR Subchapter F - Marine Engineering".
- [16] American National Standards Institute and Canadian Standards Association, "FC 1-2004, Stationary Fuel Cell Power Systems," 2004.
- [17] I. E. Commission, 62282-2 Fuel Cell Technologies - Part 2: Fuel Cell Modules, 2012.
- [18] I. E. Commission, 62282-3 Fuel Cell Technologies - Part 3-100: Stationary Fuel Cell Power Systems - Safety, 2012.
- [19] I. E. Commission, 60068-2-6 Environmental Testing – Part 2-6: Tests – Test Fc: Vibration (Sinusoidal), 2007.
- [20] Lennie Klebanoff and Joe Pratt, Sandia National Laboratories, "Assessing Risk of Fire to the Aluminum Deck in the SF-Breeze," 2015.
- [21] United States Environmental Protection Agency, "Commercial Marine Emission Inventory Development - Final Report," Environ International Corporation, Novato, CA, July 2002.
- [22] United States Environmental Protection Agency, "Emission Facts," US EPA, Washington DC, February 2005.
- [23] Sandia National Laboratories, "High-Speed Hydrogen Fuel Cell Ferry (SF-BREEZE) Regulatory Discussion," PowerPoint Presentation, November 10, 2015.

Appendix A

Vessel Drawings

CONFIDENTIAL AND PROPRIETARY PROPERTY OF
Elliott Bay Design Group LLC
 MAY NOT BE USED FOR CONSTRUCTION OR PROVIDED TO
 ANY THIRD PARTIES WITHOUT PRIOR WRITTEN CONSENT.
 ©2016 ELLIOTT BAY DESIGN GROUP.

REVISION HISTORY

REV	ZONE	DESCRIPTION	DWN	DATE	APVD
-----	------	-------------	-----	------	------

GENERAL NOTES

- THIS DRAWING IS PART OF A PRELIMINARY PACKAGE THAT HAS BEEN DEVELOPED TO THE CONCEPT LEVEL. IT IS NOT INTENDED FOR CONSTRUCTION AND HAS RESERVATIONS THAT WILL REQUIRE FURTHER DEVELOPMENT.
- THIS CONCEPT DESIGN HAS BEEN DESIGNED TO MEET THE STANDARDS, RULES AND REGULATIONS OF THE FOLLOWING PUBLICATIONS IN PART OR IN FULL: 46 CFR SUBCHAPTER T, ABS GUIDE FOR BUILDING AND CLASSING HIGH-SPEED CRAFT, RESOLUTION MSC.391(95) – ADOPTION OF THE INTERNATIONAL CODE OF SAFETY FOR SHIPS USING GASES OR OTHER LOW-FLASHPOINT FUELS (IGF CODE).

PRINCIPAL DIMENSIONS

LENGTH OVERALL:	109'-0"
LENGTH DESIGN LOAD WATERLINE:	99'-4"
BEAM:	33'-0"
DEPTH FROM MAIN DECK:	11'-3"
DRAFT TO DLWL (HULL):	55"
PASSENGER CAPACITY:	150
CREW:	4
LIQUEFIED HYDROGEN TANK CAPACITY:	4465 GAL (1200 kg)
SERVICE SPEED:	35 KNOTS
INSTALLED POWER (FUEL CELLS)	4.92 MW

REFERENCES

Elliott Bay Design Group
 Seattle • New Orleans • Ketchikan

CLIENT
SANDIA NATIONAL LABORATORIES
 LIVERMORE, CALIFORNIA

PROJECT
 SF-BREEZE FERRY FEASIBILITY STUDY

GENERAL ARRANGEMENT

SIZE	D	DWG NO.	15051-001-101-1	REV	—
SCALE	3/16"=1'-0"	FILE NAME	15051-001-101-1-	SHEET	1 OF 3
DWN	REMc	MOD	EMT	CRD	CML
APVD	KTS	APVD DATE	2/12/16		

HALF SIZE PRINT

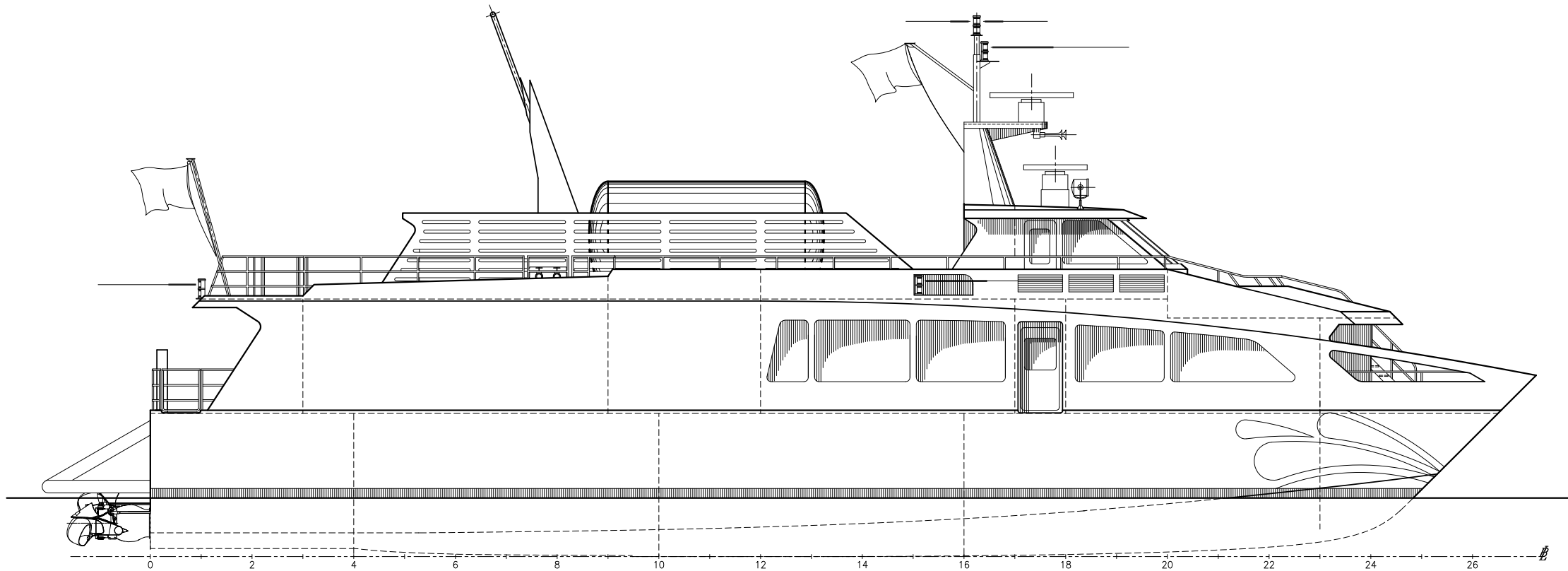
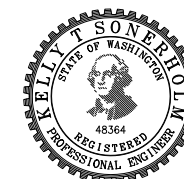

OUTBOARD PROFILE

CONFIDENTIAL AND PROPRIETARY PROPERTY OF
Elliott Bay Design Group LLC
 MAY NOT BE USED FOR CONSTRUCTION OR PROVIDED TO
 ANY THIRD PARTIES WITHOUT PRIOR WRITTEN CONSENT.
 ©2016 ELLIOTT BAY DESIGN GROUP.

6

5

4

3

2

1

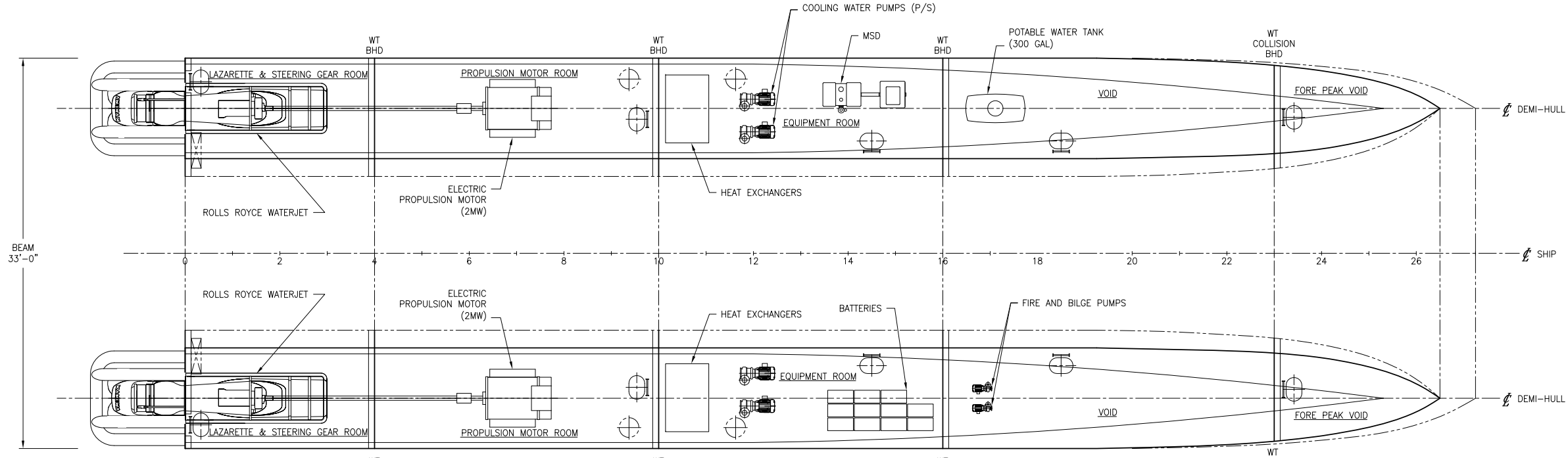

HOLD ARRANGEMENT PLAN

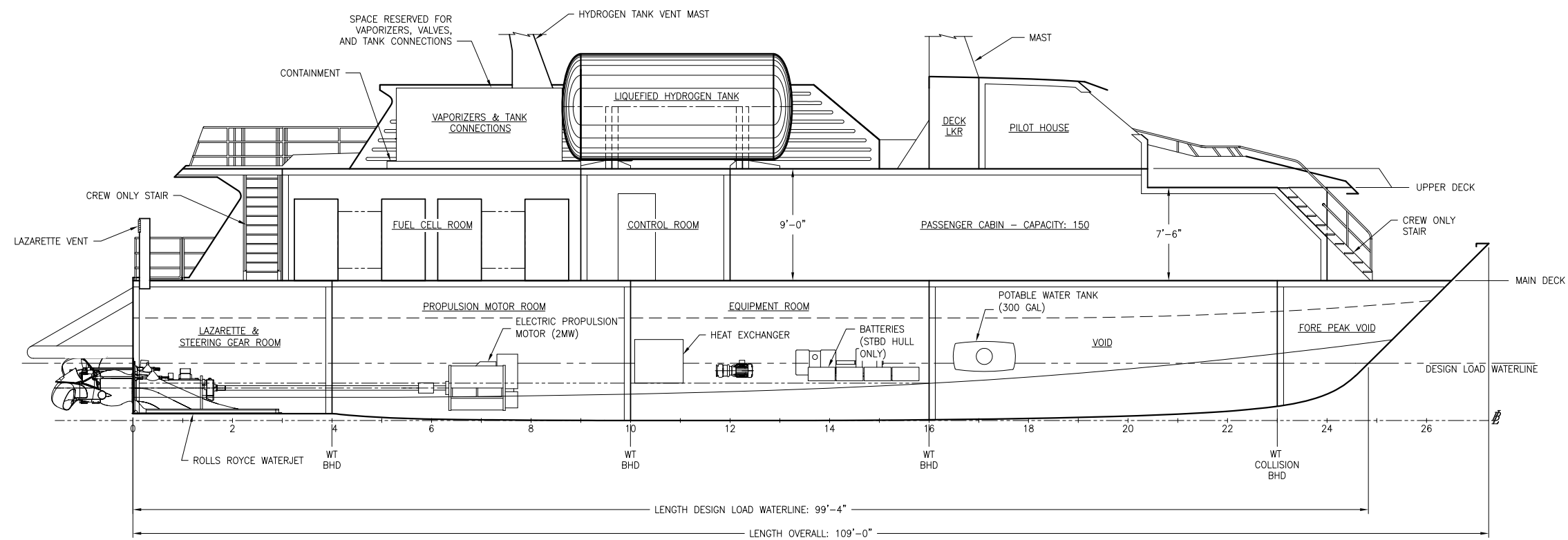

INBOARD PROFILE

STBD DEMI-HULL SHOWN, PORT DEMI-HULL SIMILAR
 FRAME SPACING: 48"



HALF SIZE PRINT

SIZE	D	DWG NO.	15051-001-101-1	REV	-
SCALE	3/16"=1'-0"	FILE NAME	15051-001-101-1-	SHEET	2 OF 3

6

5

4

3

2

1

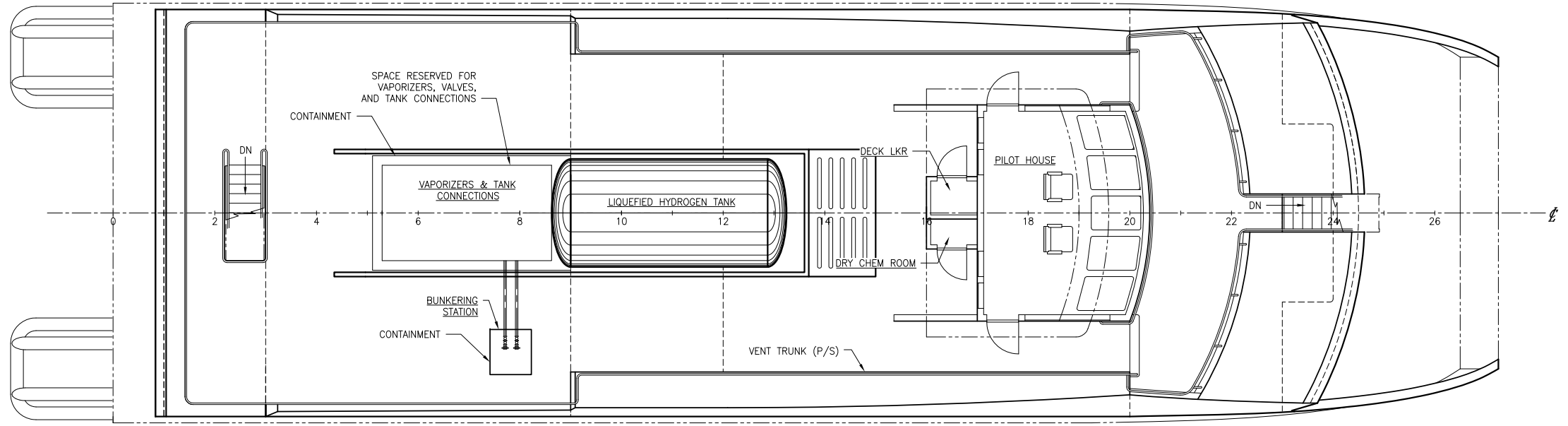

UPPER DECK ARRANGEMENT PLAN

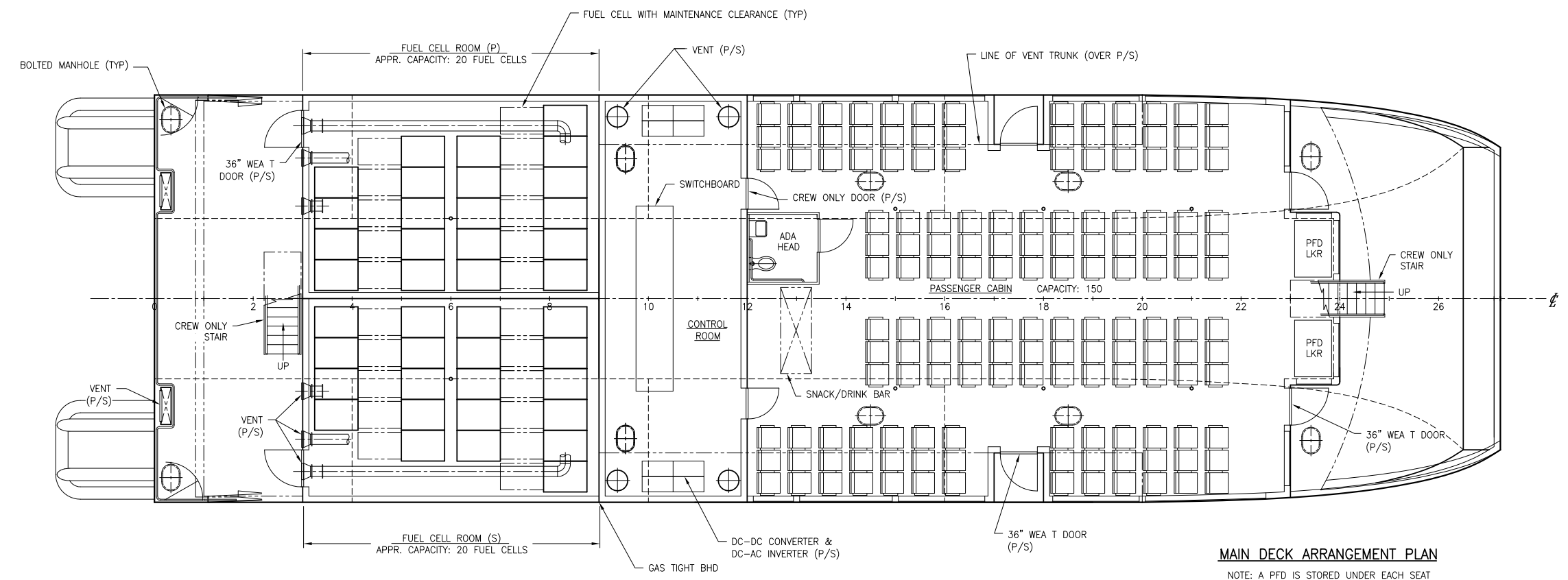

MAIN DECK ARRANGEMENT PLAN

NOTE: A PFD IS STORED UNDER EACH SEAT



HALF SIZE PRINT

SIZE	D	DWG NO.	15051-001-101-1	REV	-
SCALE	3/16"=1'-0"	FILE NAME	15051-001-101-1-	SHEET	3 OF 3

CONFIDENTIAL AND PROPRIETARY PROPERTY OF
Elliott Bay Design Group LLC
 MAY NOT BE USED FOR CONSTRUCTION OR PROVIDED TO
 ANY THIRD PARTIES WITHOUT PRIOR WRITTEN CONSENT.
 ©2016 ELLIOTT BAY DESIGN GROUP.

HAZARDOUS ZONES KEY	
HATCH	ZONE DESIGNATION
	ZONE 0
	ZONE 1
	ZONE 2

REVISION HISTORY					
REV	ZONE	DESCRIPTION	DWN	DATE	APVD

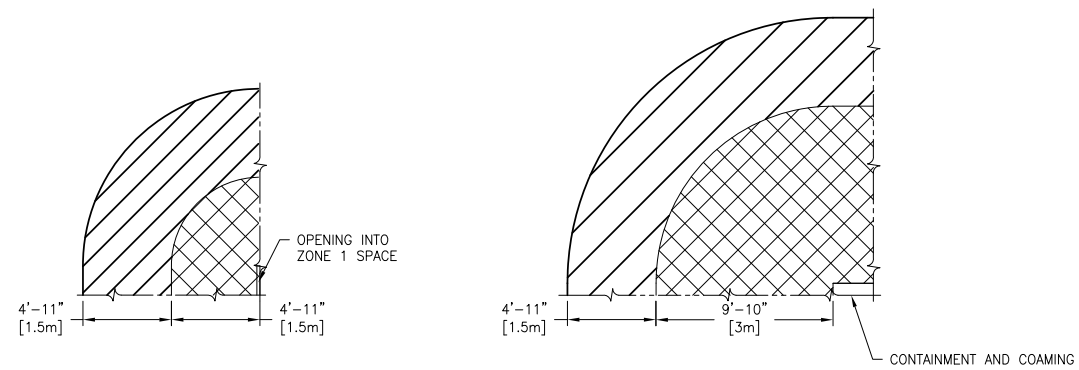
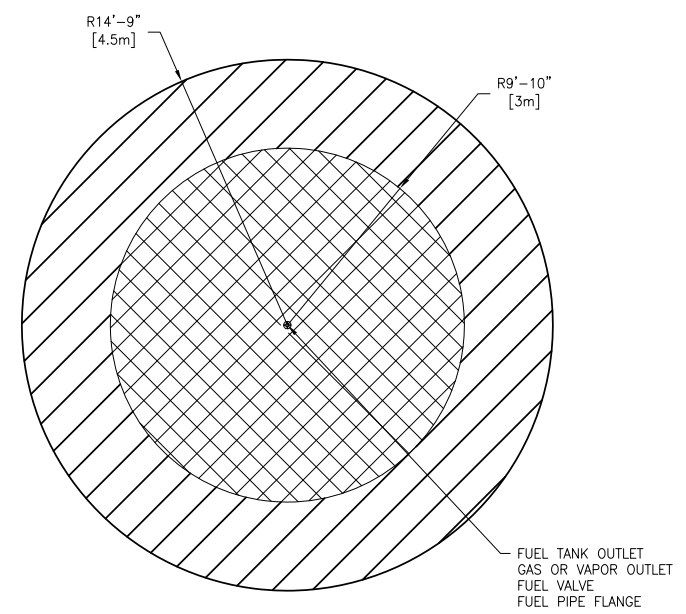

LEGEND

- GENERAL NOTES**
- THIS DRAWING IS PART OF A PRELIMINARY PACKAGE THAT HAS BEEN DEVELOPED TO THE CONCEPT LEVEL. IT IS NOT INTENDED FOR CONSTRUCTION AND HAS RESERVATIONS THAT WILL REQUIRE FURTHER DEVELOPMENT.
 - THIS CONCEPT DESIGN HAS BEEN DESIGNED TO MEET THE STANDARDS, RULES AND REGULATIONS OF THE FOLLOWING PUBLICATIONS IN PART OR IN FULL: 46 CFR SUBCHAPTER T, ABS GUIDE FOR BUILDING AND CLASSING HIGH-SPEED CRAFT, RESOLUTION MSC.391(95) - ADOPTION OF THE INTERNATIONAL CODE OF SAFETY FOR SHIPS USING GASES OR OTHER LOW-FLASHPOINT FUELS (IGF CODE).
 - THIS DRAWING SHOWS THE ARRANGEMENT OF HAZARDOUS ZONES FOR THE VESSEL BASED ON HAZARDOUS ZONES REQUIREMENTS.
 - THE FOLLOWING ZONE DEFINITIONS WERE USED (REF 5):
 - ZONE 0: AN AREA IN WHICH AN EXPLOSIVE GAS ATMOSPHERE IS PRESENT CONTINUOUSLY OR FOR LONG PERIODS OR FREQUENTLY. APPLIED ONLY TO LH2 RELATED SPACES.
 - ZONE 1: AN AREA IN WHICH AN EXPLOSIVE GAS ATMOSPHERE IS LIKELY TO OCCUR DURING NORMAL OPERATION OCCASIONALLY. APPLIED ONLY TO LH2 RELATED SPACES.
 - ZONE 2: AN AREA IN WHICH AN EXPLOSIVE GAS ATMOSPHERE IS NOT LIKELY TO OCCUR DURING NORMAL OPERATION, BUT, IF IT DOES OCCUR, WILL PERSIST FOR A SHORT PERIOD ONLY. APPLIED ONLY TO LH2 RELATED SPACES.
 - ALTERNATE DIMENSIONS IN BRACKETS ARE METRIC DIMENSIONS, WHICH PROVIDE A MORE DIRECT COMPARISON TO RELEVANT REGULATION REQUIREMENTS FOR DISTANCES OF HAZARDOUS ZONES.
 - INTERIORS OF LH2 TANK, PIPING, AND VENTING ARE ZONE 0 HAZARDOUS SPACES.

- REFERENCES**
- 15051-001-101-1 GENERAL ARRANGEMENT
 - MSC.391(95) - INTERNATIONAL CODE OF SAFETY FOR SHIPS USING GASES OR OTHER LOW-FLASHPOINT FUELS (IGF CODE)
 - IEC 60092-502 - ELECTRICAL INSTALLATIONS IN SHIPS
 - COMPARISON OF LH2 AND LNG PROPERTIES WITH A FOCUS ON SAFETY - SANDIA NATIONAL LABORATORIES
 - IEC 60079-10 - ELECTRICAL APPARATUS FOR EXPLOSIVE GAS ATMOSPHERES

Elliott Bay Design Group
 Seattle • New Orleans • Ketchikan
 CLIENT: **SANDIA NATIONAL LABORATORIES**
 LIVERMORE, CALIFORNIA
 PROJECT: **SF-BREEZE FERRY FEASIBILITY STUDY**

HAZARDOUS ZONES PLAN

SIZE	D	DWG NO.	15051-001-101-2	REV	-
SCALE	3/16"=1'-0"	FILE NAME	15051-001-101-2-	SHEET	1 OF 3
DWN	EMT	MOD		APVD	
			CML		
				APVD DATE	2/12/16

HALF SIZE PRINT



6

5

4

3

2

1

6

5

4

3

2

1

CONFIDENTIAL AND PROPRIETARY PROPERTY OF
Elliott Bay Design Group LLC
 MAY NOT BE USED FOR CONSTRUCTION OR PROVIDED TO
 ANY THIRD PARTIES WITHOUT PRIOR WRITTEN CONSENT.
 ©2016 ELLIOTT BAY DESIGN GROUP.

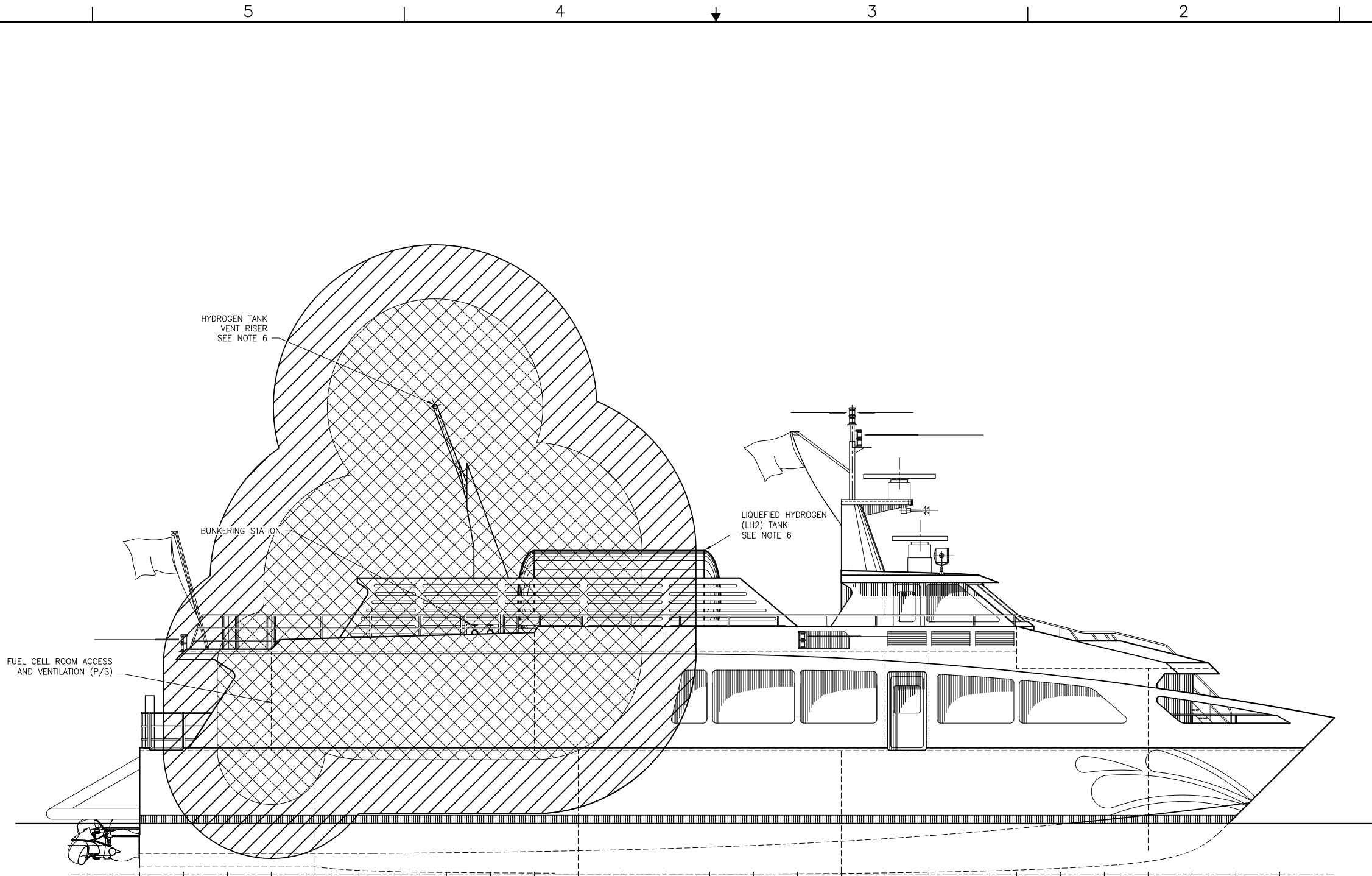

PROFILE 2-3B
 EXTERIOR HAZARDOUS ZONES
 NOTE 6



CONFIDENTIAL AND PROPRIETARY PROPERTY OF
Elliott Bay Design Group LLC
 MAY NOT BE USED FOR CONSTRUCTION OR PROVIDED TO
 ANY THIRD PARTIES WITHOUT PRIOR WRITTEN CONSENT.
 ©2016 ELLIOTT BAY DESIGN GROUP.

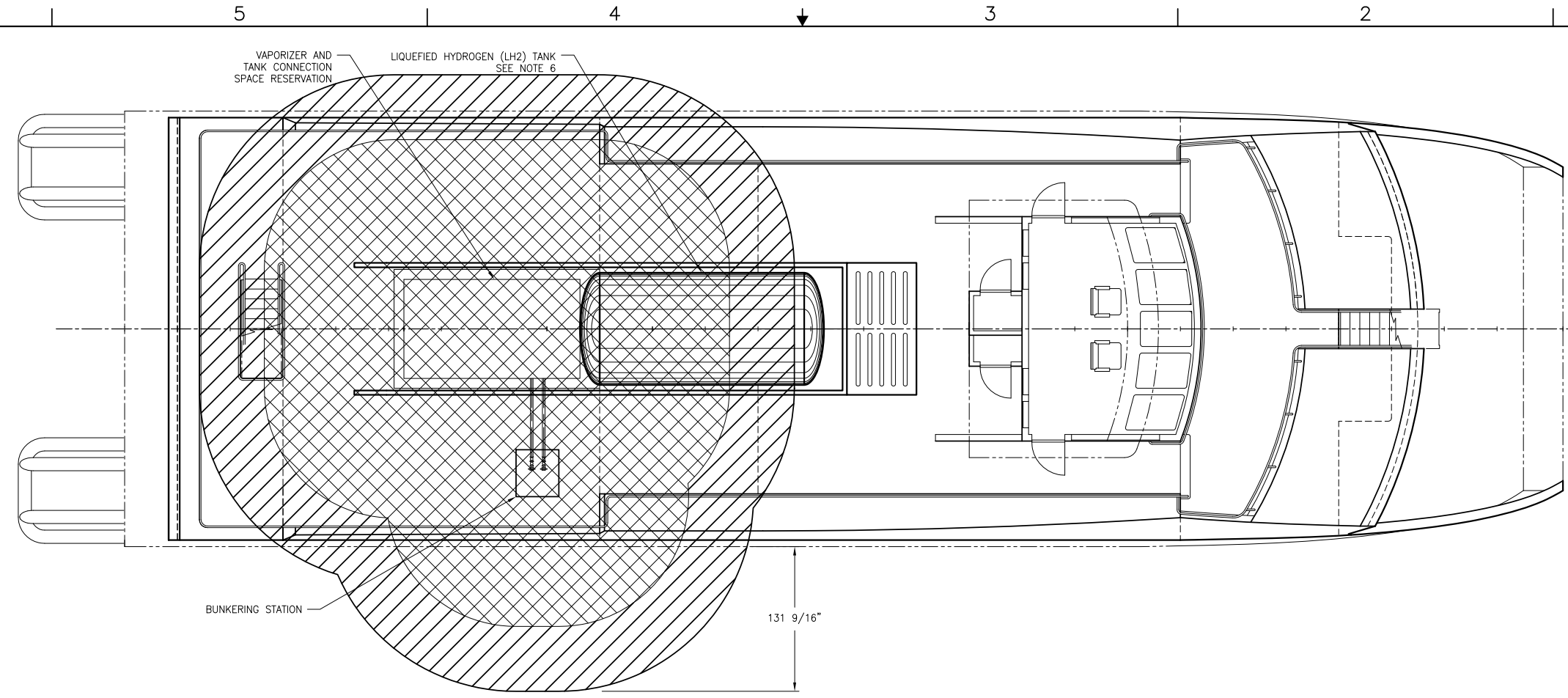

PLAN 3-3C
 UPPER DECK HAZARDOUS ZONES

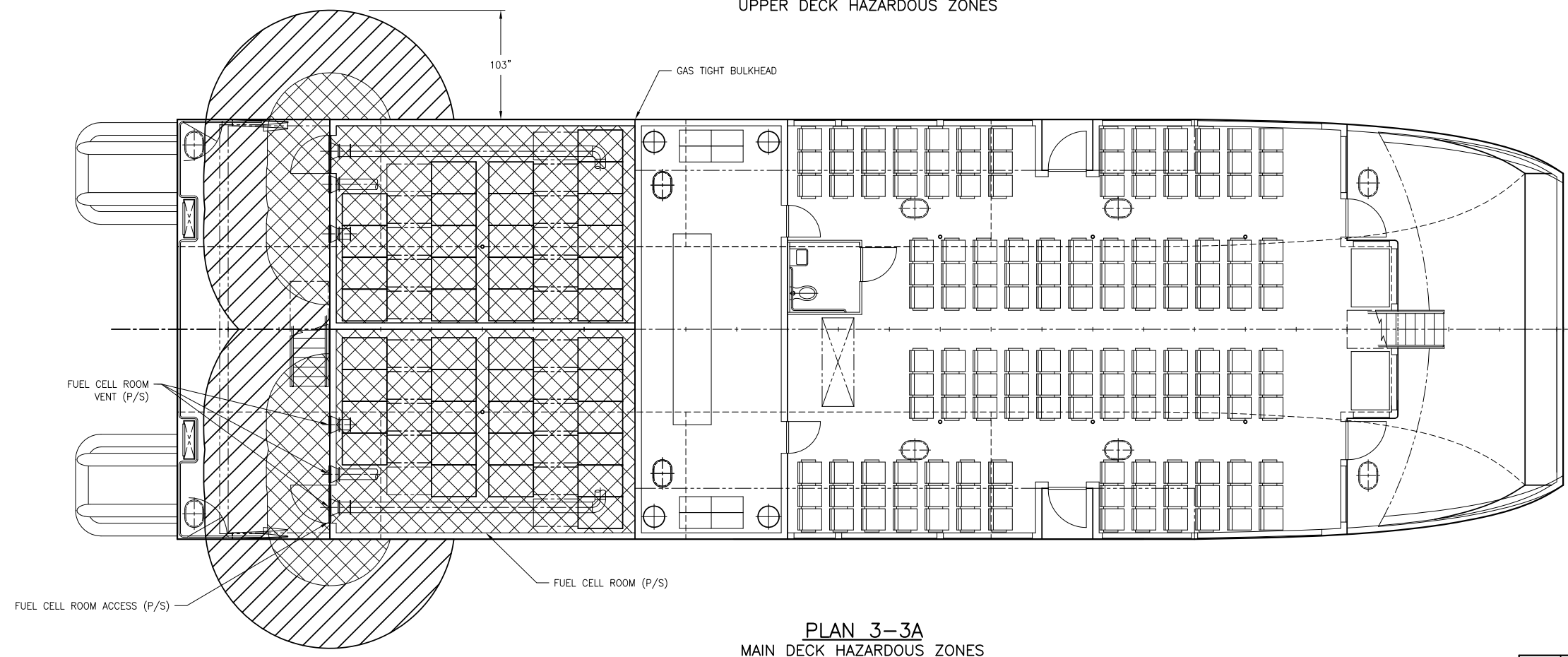

PLAN 3-3A
 MAIN DECK HAZARDOUS ZONES

HALF SIZE PRINT



SIZE	D	DWG NO.	15051-001-101-2	REV	-
SCALE	3/16" = 1'-0"	FILE NAME	15051-001-101-2-	SHEET	3 OF 3

Appendix B

Regulatory Gap Analysis

115051 SF-BREEZE Fuel Cell Ferry Regulatory Gap Analysis

Source	12	13	14
1 46 CFR Subchapter T - Small Passenger Vessels	12 IEC 62282-2 Fuel Cell Technologies - Part 2	13 IEC 62282-3 Fuel Cell Technologies - Part 3	14 60006-2-6
2 IMO MSC.92/22/Add.1 (Adopted IGF Code)			
3 IMO CCC Z/11 (IGF Code with Fuel Cell Additions)			
4 ABS Guide for Propulsion and Auxiliary Systems for Gas Fueled Ships			
5 ABS Rules for Building and Classing High-Speed Craft			
6 IEC 60092-502 Electrical Installations in Ships			
7 IEC 60079-10 Electrical Apparatus for Explosive Gas Atmospheres			
8 46 CFR Subchapter J - Electrical Engineering			
9 46 CFR Subchapter F - Marine Engineering			
10 ASME B31.12 Hydrogen Piping and Pipelines			
11 ANS/CSA America FCI-2004			

Categories	A	R	G	I
Applicable Requirement	A	R	G	I
Identified Potential Regulatory Change				I

Compliance	F	P
Full Compliance	F	P
Partial Compliance		P

SWIS Number	SWIS Title	Description	Source	Category	Section	Compliance	Comments
100	Hull structure	Structural design	5	G		F	Although the vessel is not intended to be ABS classed the structure will be designed to ABS rules.
101	General Arrangements	Fuel cell room arrangements	2	G	Per Section 5.6	F	In order to use gas supply piping without a gastight external enclosure, the engines generating power shall be located in two or more machinery spaces not having any common boundaries unless it can be documented that a single casualty will not affect both spaces.
		Fuel cell room arrangements	4	G	Per Section 2/2.6.1	F	Where single wall fuel gas piping is applied the bulkhead between two gas machinery spaces shall be class A-60 and the machinery space shall be as simple a geometrical shape as possible and be as small in volume as practicable, without sacrificing maintainability, in order to facilitate effective ventilation and gas detection.
		Fuel cell arrangements	3	G	Per Section 10.6.3.6.1	F	Fuel cell power systems shall be located in separate spaces with gastight enclosures.
		Fuel cell room arrangements	4	G	Per Section 2/3	F	Access to a single wall fuel gas piping concept machinery spaces is to be by self-closing gastight doors. An audible and visual alarm is to be provided at a permanent manned location. Alarm is to be given if the door is open continuously for more than 60 seconds.
		Bunkering station arrangement	4	G	Per Section 2/2.4	F	The bunkering station(s) and manifold(s) are to be located on the open deck so that sufficient natural ventilation is provided. The bunkering station is to be physically separated or structurally shielded from adjacent normally manned areas.
		Hazardous zones	2	G	Per Section 12.5	P	Zone 0 - Intercos of fuel tanks, piping, and venting. Zone 1 - Areas on open deck within 3m of any fuel tank outlet, gas or vapor outlet, bunker manifold valve, fuel tank flange, areas within 1.5m of any opening into a zone 1 space, areas on the open deck within spillage coaming surrounding gas bunker manifold valves and 3m beyond these, the ESD protected machinery space is considered non-hazardous during normal operation but will require equipment required to operate following the detection of gas leakage to be zone 1. Zone 2 - areas within 1.5m of zone 1.
		Compartments designations			SOLAS Ch. II-2/ Table 9.5 and 9.6	F	Incorporated by reference from the IGF Code (Source 2). Class designations for compartments/spaces on the vessel.
200	Propulsion plant	Fuel cells	11,12,13,14	G		F	Fuel cell design will also be UL compliant.
230	Propulsion units	Propulsion machinery	1	A	Per Part 383, Subpart B	F	Propulsion machinery of an unusual type for small passenger vessels must be given separate consideration and is subject to such requirements as determined necessary by the cognate OCH.
		Electric propulsion	8	A	Per Part 111.35	F	Subchapter T - points toward 48-5/2.11 (Propulsion control), 48-5/2.13 (Instrumentation at the Control Station), 48-5/2.14(a), 48-5/2.17, 48-5/2.17.5, 48-5/2.17.10 of ABS Steel Vessel Rules.
		Emergency propulsion	4	G	Per Part 2/5.1	F	The propulsion and auxiliary arrangements and fuel supply systems are to be arranged so that in the case of emergency shutdown of the fuel gas supply the propulsion and maneuvering capability, together with power for essential services, can be maintained. Under such a condition the remaining power is to be sufficient to provide for a speed of at least 7 knots or half of the design speed, whichever is the lesser.
256	Cooling water system	Ventilation	2	G	Per Section 13.1	P	Arrangements for enclosed non-hazardous spaces shall be at least 1.5m away from any hazardous zone. Air outlets for enclosed non-hazardous spaces should be located outside of any hazardous zone.
		Gas extraction measures	3	G	Per Section 10.6.3.5.5	F	Auxiliary systems of the fuel cell power system where gas may leak directly into a system medium (e.g. cooling water) shall be equipped with appropriate gas extraction measures fitted directly after the media outlet from the system in order to prevent gas dispersion. The gas extracted shall be vented to a safe location on open deck.
		Gas fuel supply - ESD machinery space	2	G	Per Section 9.2	F	Pressure in system shall not exceed 1.0MPa. Design pressure of supply lines should not be less than 1.0MPa.
		Gas fuel supply safety	2	G	Per Section 9.4	F	Gas supply line valve arrangements for fuel storage tank inlets and outlets, main gas supply line to each power consumer, and main gas supply lines entering ESD protected machinery spaces.
		LH2 Tank	2	G	Per Section 9.3	F	For type C tank only, one tank may be accepted if two completely separate tank connection spaces are installed for the one tank.
		Type C Independent tank	2	G	Per Section 6.4.15.3	F	Type C Independent tank (pressure vessel) design criteria reserved pending further information from tank manufacturers.
		Tank placement on open deck	2	G	Per Section 5.3	F	Fuel tank shall be located at a minimum distance of 8/9 or 11.5m, whichever is less, measured inboard from the ship side at right angles and a minimum distance of 8/10, but no less than 0.8m, from the shell plating or aft terminal. For multihull ships the value of 8 may be specially considered.
		Drip Tray	2	G	Per Section 5.10	F	Drip trays are required where leakage may occur which can cause damage to the ship structure.
		Pressure relief and venting	2	G	Per Section 6.2	P	All fuel storage tanks shall be provided with a pressure relief system appropriate to the design of the fuel containment system and the fuel being carried. The outlet from the pressure relief valves shall normally be located at least 10m from the nearest: 1. air intake, air outlet or opening to accommodation, service and control spaces, or other non-hazardous area; and 2. exhaust outlet from machinery installations.
		Pressure relief and venting (gas dispersion analysis)	4	G	Per Section 3/3	F	Propose for alternative pressure relief valve outlet positions will be considered on a case-by-case basis and subject to the submission of an appropriate safety case. Such a safety case could be based on a vessel specific gas dispersion analysis. In that case the air intake is to be provided with a gas detection system which will activate visual and audible alarms when the gas concentration reaches 20% of LEL. However in no case are air intakes to be located less than 4.5m from a relief valve outlet.
		Tank storage level	2	G	Per Section 6.8	F	In cases where the tank insulation and tank location make the probability very small for the tank contents to be heated up due to an external fire, special considerations may be made to allow a higher loading limit than calculated using the reference temperature, but never above 95%.
		Vaporizer	4	G	Per Section 5/5.2	F	Vaporizer to be to be designed, constructed and certified in accordance with Sections 4.4.1 and 5.4.5 of the Steel Vessel Rules.
300	Electric plant	Electrical equipment in haz zones (ESD)	2	G	Per Section 14	F	Electrical installations shall be in compliance with a standard at least equivalent to those acceptable to the Organization. - IEC 60092-502.
		Electrical equipment in haz zones (ESD)	7	G	Incorporated by reference from the IGF Code	F	
		Electrical installations in haz zones	6	G	Per Section 5 and 7	F	Incorporated by reference from the IGF Code (Source 2).
		Electrical equipment in haz zones	6	G	Per Section 6	F	Incorporated by reference from the IGF Code (Source 2).
		Electrical installations and equipment outside of haz zones	1	A	Per Part 383, Subpart C	F	General Subchapter T regulations for power sources and distribution systems for all non-hazardous spaces.
		ESD machinery space electrical equipment	8	A	Subchapter J	F	ESD machinery space electrical equipment shall be certified safe for zone 1. All equipment not certified safe for zone 1 shall be automatically disconnected in the event of gas concentrations above 40% LEL.
		Lighting system outside of haz zone	1	A	Per Part 383, Subpart D	F	General Subchapter T regulations for lighting (including emergency and navigation) for all non-hazardous spaces.
400	Command and surveillance	Equipment	1	A	Per Part 384, Subpart A	F	General Subchapter T regulations for navigation equipment.
422	Navigation	Radio	1	A	Per Part 384, Subpart E	F	General Subchapter T regulations for radio systems.
430	Internal Communications	Internal Comm. Systems	1	A	Per Part 384, Subpart F	F	General Subchapter T regulations for internal communication systems.
436	Alarm and monitoring	LH2 equipment and systems	2	G	Per Section 15	F	Control, monitoring and safety systems (tank level indication and alarm, overflow control, system pressure indication and alarm, bunkering control, ESD gas detection) for gas fuelled installations.
		Bunkering system	4	G	Per Section 4, Table 1	F	Alarm and valve automatic shutdown requirements for the fuel bunkering system.
		Fuel cell system	3	G	Per Section 10.6.3.7	F	If limit values of chemical reactions, e.g. temperature, pressure, voltage, determined for the control process which may lead to hazardous situations are exceeded, the unit shall be automatically shut down and interlocked by an independent protective device.
		Fuel cell system	4	G	Per Section 10.6.3.5.2	F	It shall be possible to switch off the fuel cell power system from a permanently accessible location outside the installation space.
		Gas detection system	3	G	Per Section 2/9	F	Permanently installed gas detectors are to be provided in machinery spaces containing fuel pipes. Gas detection system shall be self monitoring and readily tested. Audible and visual alarms are to be located in the bridge and control rooms.
		Vaporizer	4	G	Per Section 5, Table 1	F	Inlet temperature and discharge pressure and temperature shall have monitor, alarm, and shutdown capabilities.
500	Auxiliary systems	Fuel piping	2	1	Per Section 7	P	Material and general pipe design (wall thickness, flexibility, connections, etc.) for down to minus 165°C. The regulations for design temperatures below minus 165°C shall be specially agreed with the Administration.
		Location and protection of piping	10	G	Per Sections 1.2 and Appendix X	F	Material specifications for piping, in gaseous and liquid hydrocarbon service.
		Single wall piping	2	G	Per Section 5.7	F	Piping shall be located at least 800mm from the ship's side. Fuel piping shall not be led directly through accommodation or control spaces. Gas piping in ESD spaces shall be located as far as practicable from electrical installations.
		Single wall piping	3	G	Per Section 10.6.3.6.9	F	The double wall principle is not to be used for hydrogen pipes. Hydrogen pipes are as far as practicable to be fully welded. The number of connections shall be minimized.
		Single wall piping	2	G	Per Section 5.6.3	F	Single wall piping is acceptable provided engines generating power shall be located in two or more machinery spaces (sharing a common bulkhead is acceptable with documentation that an explosion or casualty in one will not affect the other), gas machinery spaces contain minimal equipment only necessary for operation, and a fixed gas detection system arranged automatically shutdown all equipment not zone 1 certified.
		Single wall piping	4	G	Per Section 2/4.1	F	Gas pipes are not to be located less than 800mm from the ship's side. Gas vent piping from tank relief valves, bunker station relief valves and block and bleed valves may be single walled when located on the open deck.
		Bunkering station	2	G	Per Section 8.3	F	Bunkering system, manifold, and hose general regulations.
		Bunkering station	4	G	Per Section 2/2.4	F	Where the leakage containment arrangements are such that damage to the hull structure from accidental spillage of LNG during bunkering operations cannot be precluded, additional measures such as a low-pressure water curtain, are to be fitted under the bunkering station to provide for additional protection of the hull steel and the ship's side structure.
		Bunkering station	4	G	Per Section 4/5	F	Fuel gas bunkering system, piping, and manifold requirements. An emergency shutdown system shall be fitted to stop bunker flow in case of an emergency.
512	Ventilation	Fuel Cell room ventlation	2	G	Per Section 13.5	F	Ventilation system for gas machinery spaces shall be separate from other ventilation systems. Shall have a capacity of 15 air changes per hour in normal conditions, with an increase to 30 air changes per hour in case of a detected gas leak. Number and power of fans shall be designed to provide at least a 50% capacity redundancy in case of an inoperable fan.
		Fuel Cell room ventilation	2	G	Per Section 15.10	F	Any loss of ventilating capacity should sound an alarm and activate the safety shutdown in the ESD machinery space.
		Fuel Cell room ventilation	3	G	Per Section 10.6.3.3	F	Exhaust air and residual gases of the fuel cells power systems shall not be combined with ventilation air and shall be led to the open air and [3m] away from any entrances, ventilation inlets and other openings.
521	Firemain system	Fire main	1	A	Per Part 381, Subpart C	F	General Subchapter T regulations for the fire main system for all non-hazardous zones and gas spaces.
		Fire zones	3	G	Per Section 10.6.3.2	F	The fuel cell space shall be considered as a machinery space of category A.
		Fire zones	2	G	Per Section 11.4	F	Where spray systems are allowed to be part of the fire main as long as there is enough capacity.
		Water spray	2	G	Per Section 11.5	F	A water spray system shall be installed for cooling and fire prevention to cover parts of the tank exposed on open deck. It shall also provide coverage for boundaries of normally occupied deckhouses that face the storage tank (2.0m away).
		Fire detection and alarm	2	G	Per Section 11.7	F	A fixed fire detection and fire alarm system complying with the Fire Safety Systems Code shall be provided for the fuel storage hold spaces and the ventilation trunk for fuel containment system below deck, and for all other rooms of the fuel gas system where fire cannot be excluded.
		Fixed fire extinguishing system	1	A	Per Part 381, Subpart D	F	General Subchapter T regulations for the fixed fire extinguishing system required in spaces with propulsion machinery (non-hazardous zones and gas spaces).
		Bunkering station	4	G	Per Section 4/9	F	Permanently installed dry chemical powder extinguishing system is to cover all possible leak points.
		Bunkering station	2	G	Per Section 11.6	F	Permanently installed dry chemical powder extinguishing system is to cover all possible leak points.
600	Outfit and furnishings	Seats	1	A	Per Part 377, Subpart H	F	General Subchapter T regulations for passenger accommodations.
640	Interior Furnishings	Seats	1	A	Per Part 380	F	General Subchapter T regulations for lifesaving equipment on a passenger vessel.
690	Lifesaving	Lifesaving equipment and arrangements	1	A	Per Part 380	F	General Subchapter T regulations for lifesaving equipment on a passenger vessel.
800	Integration/Engineering	Vessel stability requirements	1	A	Per Parts 178 and 179	F	General Subchapter T regulations for stability, damage stability, subdivision on a passenger vessel.
843	Stability	Vessel stability requirements	1	A	Per Parts 178 and 179	F	General Subchapter T regulations for stability, damage stability, subdivision on a passenger vessel.



SF-BREEZE FERRY FEASIBILITY STUDY

Qualitative Hull Comparison

Prepared for: Sandia National Laboratories • Livermore, CA

Ref: 15051-001-070-1

Rev. -

October 13, 2015

PREPARED BY

Elliott Bay Design Group
5305 Shilshole Ave. NW, Ste. 100
Seattle, WA 98107

GENERAL NOTES

NA

REVISIONS

REV	DESCRIPTION	DATE	APPROVED
P0	Preliminary Issue	9/17/15	
-	Initial Issue	10/13/15	KTS 48364

CONFIDENTIAL AND PROPRIETARY PROPERTY OF
ELLIOTT BAY DESIGN GROUP LLC
MAY NOT BE USED FOR CONSTRUCTION OR PROVIDED TO
ANY THIRD PARTIES WITHOUT PRIOR WRITTEN CONSENT.
© 2015 ELLIOTT BAY DESIGN GROUP.

TABLE OF CONTENTS

	PAGE
1 Executive Summary	1
2 Purpose	1
3 Vessel Requirements	1
4 Hydrogen Fuel System considerations	2
5 Vessel Types	3
5.1 Definitions	3
5.2 Monohull	5
5.2.1 Service	5
5.2.2 Comfort	6
5.2.3 Arrangements	6
5.2.4 Cost	6
5.3 Catamaran	7
5.3.1 Service	7
5.3.2 Comfort	7
5.3.3 Arrangements	7
5.3.4 Cost	8
5.4 Trimaran	8
5.4.1 Service	9
5.4.2 Comfort	9
5.4.3 Arrangements	9
5.4.4 Cost	9
6 Discussion	10
6.1 Existing Vessels with Traditional Power Plants	10
6.2 Existing Vessels with LNG Power Plants	11
7 Conclusion	13
7.1 Monohull	13
7.2 Catamaran	13
7.3 Trimaran	13
7.4 Recommendation	14
8 References	15
Appendix A	16
Candidate Hull Drawings	16
Monohull Drawings	17
Catamaran Drawings	20
Trimaran Drawings	23

1 EXECUTIVE SUMMARY

The SF-BREEZE FERRY Feasibility Study Project is intended to assess the feasibility of providing high-speed ferry service to commuters in the San Francisco Bay area on ferries which are powered by hydrogen fuel cell technology. Hydrogen fuel cells use hydrogen gas as fuel rather than fossil fuels which are typically used in marine transportation. This eliminates 100% of greenhouse gasses and other harmful emissions produced by the combustion of the fuel. The vessel feasibility study is being performed by Elliott Bay Design Group, while the hydrogen fuel infrastructure and transportation systems are being independently developed by Sandia National Laboratories.

This report presents a high level comparison of three vessel options: A monohull (single hulled vessel), catamaran (a twin-hulled vessel), and a trimaran (three hulls) in order to make a recommendation of the best candidate for the feasibility study. This report does not contain any engineering content which could describe the actual cost or performance differences between the options in mathematical terms.

The conclusion of this report is that the catamaran hullform is the best option for the feasibility study. The concept design of the vessel will proceed onward with whichever candidate hullform is selected.

2 PURPOSE

The purpose of this report is to provide a high-level qualitative discussion of three vessel types considered for the concept design of the SF-BREEZE FERRY Feasibility Study Project. SF-BREEZE is an acronym which stands for "San Francisco Bay Renewable Energy Electric vessel with Zero Emissions". The vessel is powered by hydrogen fuel cell technology. The SF-BREEZE FERRY Feasibility Study Project is performed in parallel within a larger study being performed by Sandia National Laboratories which also includes a feasibility study of shoreside facilities and delivery systems for the hydrogen fuel.

The conclusion of this report is a recommendation of a vessel type to use in the ferry feasibility study. Some preliminary calculations and layout drawings have been produced to support the conclusion; however, the specifics of such calculations are not included in this discussion.

3 VESSEL REQUIREMENTS

The tentative requirements for the vessel, regardless of the selected type are as follows:

Speed – 35 knots. In order to be competitive with other ferry operations in the Bay area the vessel must be able to provide an equivalent or better transit time to/from downtown San Francisco to either the North Bay or the South Bay.

Passengers – 150. 150 passengers is the maximum number of passengers that can be carried and still be subject to the United States Coast Guard (USCG) Subchapter T regulations. An increase in passengers over 150 will invoke Subchapter K regulations which are more restrictive and costly.

Overall Length – 130 to 150 feet. It is preferable for maneuvering restrictions that the vessel is kept below 130 feet long. If this is not possible, the maximum length has been set at 150 feet.

Tonnage – 100 Gross Register Tons (GRT). Tonnage, which is a statutory method of measuring the available space on board a vessel available for revenue generating purposes, must be limited to 100 GRT. If exceeded, Subchapter H regulations apply, which are more restrictive and costly than both Subchapters K and T.

Bunkering – The vessel is intended to service commuter passengers from either the North Bay or the South Bay to and from downtown San Francisco. This means that the vessel will be in operation throughout a 10-12 hour day with a lull in passenger traffic mid-day. To accommodate this demand, the vessel will need to refuel either once per day after hours, or possibly with one additional fueling period during the mid-day lull. If refueling during mid-day, it is desired that the operation occur in less than one hour to minimize the potential loss of passenger revenue.

4 HYDROGEN FUEL SYSTEM CONSIDERATIONS

A few key considerations must be made before discussing the pros and cons of each vessel type with regards to the effects of installing a hydrogen power plant instead of a diesel power plant. The weight of a fuel cell power plant including electric motors, power conditioning equipment, and increased ventilation and cooling requirements appears to be somewhat higher than that of a similarly sized diesel plant. The physical space requirements for hydrogen system components are also greater than with diesel. The weight of a liquid hydrogen storage system may be two to three times higher than an equivalent amount of diesel fuel storage, or possibly as high as five times as high if using compressed hydrogen storage. The space requirements are also greater for hydrogen storage vs. diesel, and there is far less flexibility in their location due to hazardous area classifications, fire protection requirements, ventilation requirements, and the less space-efficient shape of the prefabricated tanks.

Increased weight has the potential for the greatest impact on the design of this vessel, as compared with ferries on the same routes of operation in San Francisco Bay, because a 35 knot boat of this size would be most efficient if designed to be a "planing" craft. A planing craft is one which relies on dynamic lift on the bottom of the vessel to reduce drag by reducing the wetted surface of the vessel. A planing vessel that weighs too much will experience a more notable decrease in efficiency vs. a non-planing displacement vessel.

Space constraints are, of course, also an important consideration. Passenger ferries already require large deck areas to accommodate the passenger compliment which would compete with space for fuel system components. If the vessel size needs to be increased to include more area for hydrogen components, then the vessel will be larger, heavier, and require more power to make speed.

5 VESSEL TYPES

The three candidate vessel types in this discussion are:

1. Monohull – One single hull
2. Catamaran – Two hulls (demihulls), symmetrical about the longitudinal centerline of the vessel
3. Trimaran – Three hulls, one centerline hull and two (typically) smaller outrigger hulls, or "amas"

Whichever vessel type is selected, the hull would most likely be constructed of aluminum to reduce weight as compared with steel construction. Materials with a higher strength to weight ratio, such as fiberglass or carbon fiber, may be considered at an increased cost and/or reduced durability in order to further reduce weight. At a 35 knot speed, the propulsor would most likely be twin waterjets.

5.1 Definitions

Several nautical terms are used throughout this report which may be unfamiliar to the reader.

Aft – Refers to the back end of the vessel. May also indicate a direction pointing towards the back end of the vessel.

Baseline – A horizontal plane located at the bottom of the hull used for vertical reference.

Beam – Beam is the width of the vessel. This may refer to the overall width of the vessel, or, in the case of multihulled vessels, this may refer to the width of individual hulls.

Chine – A chine is a corner between the relatively horizontal bottom of the vessel and the relatively vertical side of the vessel. Sometimes more than one chine may be present which would reduce the sharpness of the chine angles. Chines typically extend along the majority of the length of the vessel. They may be present for a number of reasons including improving the ease of construction, and improving performance of high speed planing vessels.

Depth – Typically refers to the vertical distance from the Baseline of the vessel to the Main Deck.

Draft – The depth of the water measured from the Baseline of the vessel.

"Fine" or "Fineness" – A "fine" vessel is defined as one that has a relatively high length to beam ratio. High speed vessels, such as the subject of this report, are typically finer than lower speed vessels to improve efficiency.

Forward – The front end of the vessel, or a direction pointing towards the front end of the vessel.

Hold – The compartments below the main deck of the vessel.

Main Deck – Usually defined as the most significant structural deck of the vessel, below which all compartments are watertight, and above which the main cargo carrying areas of the vessel are located.

Midship Section – This is the cross section of the vessel taken as a plane which intersects the vessel at mid-length (midship) of the vessel's hull structure.

Seas (Beam, Quartering, Head, Stern) – When referring to "Seas", Beam, Quartering, Head, and Stern refer to the direction from which the wind and waves originate. Beam would indicate waves hitting the side of the vessel, Head is the front, Stern is the Back, and Quartering is diagonally either between the Head and Beam (Head Quartering) or the Stern and Beam (Stern Quartering)

Transom – This is the flat surface found at the aft end of the vessel hull. It is typically oriented in a vertical or nearly vertical plane, and is almost always present on high speed vessels.

5.2 Monohull



Figure 1: SONOMA – A 20 knot Monohull (Ref [1])

5.2.1 Service

Though monohull vessels come in a wide variety of shapes and sizes, this vessel would need to be designed as a relatively fine, single chine, transom stern hullform similar to the Spaulding Class of ferries operating on San Francisco Bay.

The two major components of vessel resistance are viscous drag and wavemaking resistance. One way wavemaking resistance is minimized on any vessel regardless of speed is to lengthen the vessel, which allows reduction of the midship section area (the maximum cross-sectional area of the vessel) and the beam of the vessel while still maintaining the same buoyant volume or lifting surface area. With a high speed vessel, the wavemaking resistance dominates over the viscous drag, and therefore, it is even more important to minimize the midship section area and beam to improve performance.

The tradeoff to designing a narrower hullform is that transverse stability of the vessel may suffer. If the beam is reduced too much, the vessel may not have enough righting moment to maintain adequate stability when subject to rolling moments such as wind or passenger movement. With the increased space requirements of the hydrogen equipment, some of the equipment or tanks would have to be stored in a higher vertical location than would be with diesel machinery or

tanks. This would result in a higher vertical center of gravity which would further reduce transverse stability (and, therefore, increase the required beam)

To summarize, even with a diesel powered high speed vessel, there is a point at which the beam of the vessel cannot be reduced further due to stability considerations, even though it could further reduce resistance. Since the hull on a high speed monohull vessel is not as fine as a catamaran hull, this results in a relatively higher power demand. The fineness of the hull would necessarily be reduced even further because of the high center of gravity resulting from the location of the hydrogen system components. The vessel would need more power to make speed than a similarly sized catamaran.

5.2.2 Comfort

The fineness of the hull influences the accelerations and slamming forces that are experienced by the vessel as it passes through waves. Since a high speed monohull cannot be as fine as the other vessel types and maintain adequate stability, the monohull will experience greater accelerations in rough weather than a catamaran or a trimaran. These accelerations could be so much greater as to cause significantly more of the passengers to experience seasickness or distraction due to jostling or slamming noise.

Also, since the vessel is subject to rolling due to its lesser transverse stability, this will cause greater lateral accelerations to be felt by passengers if the weather is rough.

5.2.3 Arrangements

The monohull, as compared with either a catamaran or a trimaran, will have more usable hold area (area below the main deck) but less usable deck area. Based on the concept drawings included in the appendix, it is estimated that the monohull may have about 50% more usable hold space, while the catamaran may have between 25%-50% more deck space. Overall, less total usable space is likely available for the monohull vs. a similar catamaran.

With the monohull option, the lack of space above deck could be overcome by adding an additional deck, however, as described above, this would reduce stability in such a way that the monohull beam would have to be increased. With this increase in beam comes significant increase in power requirements.

5.2.4 Cost

A monohull is the simplest, lightest, and most commonly constructed type of the three candidates which would likely make it the least expensive to build. An estimate for the cost to build the structure of a monohull vs. a catamaran hull is approximately 10% less for a given hull weight. A rough estimate at the build cost of the hull as a percentage of the cost of the entire vessel is less than 25%. Since the systems on this vessel will be more expensive than that of a vessel with a typical propulsion plant, the estimated savings would probably be less than 2%. The monohull would also, however, most likely be the most expensive to operate in terms of fuel costs because of the increased power requirements.

5.3 Catamaran



Figure 2: SOLANO – A 34 knot Catamaran

5.3.1 Service

As compared with a monohull, a catamaran can have much finer hull shapes on both of its demihulls without sacrificing transverse stability. The reason for this is explained in 5.2.1. For a given vessel size and installed propulsion plant, this will allow the catamaran to make a greater top speed. One 1989 study [1] showed an average reduction in vessel resistance of a high speed planing catamaran vs. an equivalent monohull of 20-25%.

A catamaran has two propulsion plants, one in each demihull. This gives an advantage to the maneuverability of the vessel vs. both other options which can reduce docking and turnaround time. The presence of two hulls also gives an advantage due to the redundancy of the propulsion components, e.g. if one of the waterjets/electric motors is damaged, the vessel may still be able to maneuver under its own power.

5.3.2 Comfort

A catamaran hullform has greater transverse stability, which translates into less rolling when encountering beam or quartering seas. The fineness of the demihulls also reduces pitching motions and slamming loads because the vessel can basically "cut" through the waves more cleanly.

5.3.3 Arrangements

The catamaran hullform has a bridge deck which spans between the two demihulls. This provides relatively more usable deck space than a similarly sized monohull.

Overall, the catamaran would have more total space than a monohull with the option of scaling up the deck space as needed. Increasing the deck space on a catamaran as needed would have a lesser detrimental effect on power requirements compared to the monohull, because increasing the deck area on a monohull requires increasing the beam of the vessel hull, which increases resistance. Furthermore, most of the usable space on the catamaran is above the main deck, which is more accessible and reduces complexity of certain systems. Also, since much of the space is required for passengers, it is beneficial to have more deck space available relative to hold space.

One drawback of the catamaran hullform vs. monohulls is that the demihulls are narrow thus limiting the useable space within the hull for large components. The minimum beam of the demihull will be controlled by space requirements for the jet drive and electric motor. Preliminary findings show that it may not be possible to use the remaining below deck space to locate the fuel cells because of maintenance access requirements.

5.3.4 Cost

Because of the more complex shape of the hull, and the more structurally complex cost of building the bridge deck, the catamaran hullform will be heavier and more expensive to build than a monohull. Fuel cost will likely be less because of lesser powering requirements.

5.4 Trimaran



Figure 3: BONANZA EXPRESS – A 38 knot Trimaran (Ref [3])

5.4.1 Service

A trimaran solves the problem of inadequate stability on a single fine hullform by adding outriggers, or "amas". This allows a single centerline hull to be finer than a monohull but larger than individual demihulls on a catamaran. The finer hullform will result in lesser powering requirements to make top speed than a similar monohull.

A trimaran has a higher ratio of hull volume to wetted surface in the center hull and a lower ratio on the (much smaller) amas, which would probably result in a similar wetted surface (and friction drag) to that of a catamaran for a given displacement, or possibly a small increase. The wavemaking resistance is also probably comparable to that of a catamaran because of the fine hull proportions. Total powering would probably be comparable to that of a catamaran.

The maneuverability is limited vs. that of a catamaran because the amas are typically designed to be too narrow to contain any propulsion machinery.

5.4.2 Comfort

The other benefit of the finer hullform, like with a catamaran, is a smoother ride through waves. Also like a catamaran, the amas also prevent excessive rolling which is a benefit to passengers on board.

5.4.3 Arrangements

Again, like the catamaran, the trimaran has increased deck area to accommodate more passengers or equipment. The trimaran also has a larger centerline hull which may allow more of the equipment to be stored below deck and increase available space above deck.

5.4.4 Cost

With the most complex hullform and bridging structures of the three options, the trimaran would be the heaviest and most expensive to build. It likely would have similar, or possibly slightly better performance than a catamaran because it has the benefit of the fineness of a catamaran, but may also have lesser wetted surface area.

6 DISCUSSION

6.1 Existing Vessels with Traditional Power Plants

The subject vessel is different than a traditionally powered vessel in that it has higher weight and space requirements, however, it is still informative to look to existing vessel designs for comparison. On Friday of September 4, 2015, marinetraffic.com was used to account for every passenger vessel currently displaying gps navigation information in San Francisco Bay. The following table gives a list of each vessel, vessel type, and top speed range for that day. A range of top speeds was found for most vessels throughout the day and is most likely due to tidal currents. Some vessels did not move during the day but are included anyways. Some vessels operated on relatively short runs, or were small vessels. These are noted as they may not be the best examples for the subject vessel design.

The vessels are sorted from highest to lowest top speed.

Table 1: S.F. Bay Passenger Vessel

Vessel Name	Hull Type	Top Speed Range (kts)	Notes	Passenger Count	Installed hp (MW)
Napa	Cat	36-40		350	7200 (5.4)
Golden Gate	Cat	36-40		350	7200 (5.4)
Intintoli	Cat	33-36		300	4680 (3.5)
Vallejo	Cat	33-35		300	6600 (4.9)
Mare Island	Cat	32-36		300	
Solano	Cat	32-34		325	6600 (4.9)
Bay Breeze	Cat	27-29		250	2060 (1.5)
Taurus	Cat	27-28		149	
Peralta	Cat	26-28		325	
Scorpio	Cat	26-29		199	
Gemini	Cat	26		149	
Encinal	Cat	22-24		388	
Sonoma	Mono	18-20			
Marin	Mono	18-20			
Bay Monarch	Mono	15-16		788	
Katie	Mono	12-14			
Royal Star	Mono	11-12			
Provider	Mono	11-13			
Hornblower Hybrid	Cat	9	short run		
Harbor Queen	Mono	8-12			
Alcatraz Clipper	Mono	8-12	short run		
Alcatraz Flyer	Mono	8-12	short run		
Angel Island	Cat	7-9	short run, small vessel		
Osprey	Mono	-	short run, small vessel		

Vessel Name	Hull Type	Top Speed Range (kts)	Notes	Passenger Count	Installed hp (MW)
Royal Prince	Mono	-			
Naiad	Mono	-			
Pacific Hornblower	Mono	-			
S.F. Spirit	Mono	-			

Note that the vessel types fall into two basic categories. 21-40 knot vessels are without exception all catamarans. Vessels 20 knots and below are monohulls, with the exceptions being smaller vessels or vessels on shorter runs. This data suggests that for traditional propulsion types that catamarans have been proven to be the most effective hullform for a 35 knot speed. Note the absence of any trimaran vessels.

Were the SF-BREEZE being designed with traditional power, it would be clear that a catamaran hull would be the most logical choice. However, the differences in weight and space requirements must be considered.

A vessel of this size traveling at 33-35 knot speeds should be designed to be a planing hull. Planing hulls are more sensitive to weight control no matter which of the three hull types is used. The question then becomes: Does a catamaran hullform present restrictions in terms of the location of large heavy hydrogen system components? Were these components required to be located below the main deck, the answer may be yes. As mentioned above, the narrow demihulls would likely prevent location of all of the fuel cells below deck. Fortunately, one of the benefits of designing a vessel with electric propulsion is that there is a great deal of flexibility with location of the components. Because transverse stability is far less of an issue with catamaran hulls, the vertical location of these components can likely be adjusted in a way that is not possible with a monohull.

The hydrogen fuel tank (either compressed hydrogen or liquid hydrogen) is one component that does not have as much flexibility in its location. Because of its weight, the ability to locate the tank in a favorable location is one of the most important considerations in proceeding with the design. Regulations suggest that it must be located in an area that is not underneath accommodation spaces. Coast Guard policy states that LNG tanks "must" not be located below passenger spaces without demonstrating an equivalent level of safety, which would probably be quite difficult to do. This forces the tank to be located at least above main deck, if not on a higher deck. Regulations also suggest that to avoid collision damage that the tank must be located a minimum distance from the side of the vessel. Both of these requirements are easier to satisfy with a catamaran design because of A) improved transverse stability of a catamaran and B) larger overall beam of a catamaran.

6.2 Existing Vessels with LNG Power Plants

Since regulations affecting the SF-BREEZE ferry are still being researched, it may be informative to look to LNG powered high-speed vessels to assess the feasibility of such a vessel

with cryogenic fuel systems. Only one LNG powered High-Speed catamaran vessel was found. There is not as much information readily available on these vessels.

The FRANCISCO is an Incat designed 99m High Speed Ro-Ro Ferry. This vessel was launched in November of 2012 and is currently in service in Argentina. The power plant is dual fuel twin gas turbines with an installed power of 29,500 hp (22 MW), and the vessel reaches speeds of 53 knots. The vessel carries 1000 passengers and 150 cars.

7 CONCLUSION

The following is a summary of each vessel option including a list of the major pros and cons. Sketches of each option are included in the Appendix.

7.1 Monohull

Pros:

- Improved space / flexibility in locating components (other than the hydrogen fuel tanks) below deck
- Lowest cost of construction

Cons:

- Highest power requirements
- Least passenger comfort
- Lesser deck area for passengers/components
- Less maneuverable

7.2 Catamaran

Pros:

- Lower power requirements
- Best passenger comfort
- Greater / scalable deck area for passengers/components
- Transverse stability allows location of components above deck
- More maneuverable than other options
- Redundancy of propulsion systems

Cons:

- More expensive to build than monohull
- Less space below decks for components

7.3 Trimaran

Pros:

- Lower power requirements
- Good or Best passenger comfort
- Greater / scalable deck area for passengers/components
- Transverse stability allows location of components above deck

Cons:

- Most expensive to build
- Uncommon / unproven design may increase design costs or decrease design effectiveness

- Less maneuverable

7.4 Recommendation

Table 2: Comparison Matrix

	Monohull	Catamaran	Trimaran
Power Requirements	Highest	Lowest	Lowest
Maneuvering	Acceptable	Best	Worst
Comfort	Least	Best	Best
Space	Less (more below deck)	Most	Most
Build Cost	Least	Higher	Highest
Operating Cost	Most	Least	Least

The catamaran hullform is the best option because of reduced power requirements, flexibility of design, and proven history of operation in San Francisco Bay. In 6 categories listed above, it is the best option for 5. Preliminary arrangements have shown promising options for placement of all required components and adequate space for the passenger compliment.

The catamaran hullform would be recommended for a vessel of this service regardless of the power plant type, however, some of the design considerations of a hydrogen fuel cell power plant further strengthen this recommendation. These considerations are:

- 1. The need to locate components in a higher vertical location necessitates a vessel with more transverse stability**
- 2. The need to locate the LH2 tanks in an open or well-ventilated area can be more easily accomplished with a catamaran (or trimaran) as these have more available deck space.**

The trimaran should also be mentioned as a possible candidate because, the only disadvantages of this option as compared with the catamaran is increased build costs and worse maneuvering, which may not be significant. In general, the reason that there are not more high speed trimaran designs is that they do not present a clear advantage over catamarans, yet are more complex to design and build. Were an experienced designer to work on a trimaran for the intended route, it is possible that the performance characteristics could equal that of a catamaran.

8 REFERENCES

- [1] M. C. Berch, "Ferry-sonoma-MCB.jpg," Wikipedia, <https://en.wikipedia.org/wiki/File:Ferry-sonoma-MCB.jpg>, 20 June 2007.
- [2] R. S. Muller-Graf, "Resistance and Propulsion Characteristics of the VWS Hard Chine Catamaran Hull Series '89," *SNAME Transactions, Vol 110*, pp. 1-29, 2002.
- [3] W. U. gomera-b, "Bonanza Express sinking.jpg," Wikipedia, https://en.wikipedia.org/wiki/File:Bonanza_Express_sinking.jpg, 29 January 2010.

Appendix A

CANDIDATE HULL DRAWINGS

Monohull

Catamaran

Trimaran

Monohull Drawings

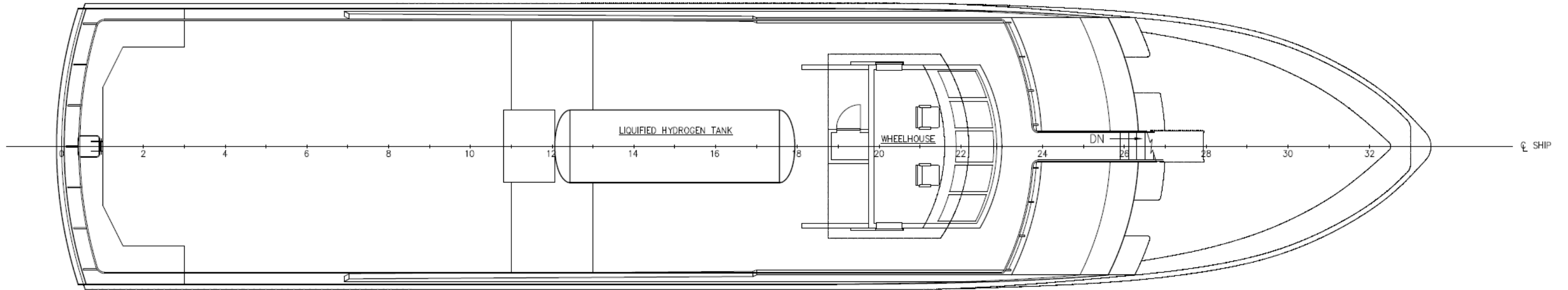

UPPER DECK ARRANGEMENT PLAN

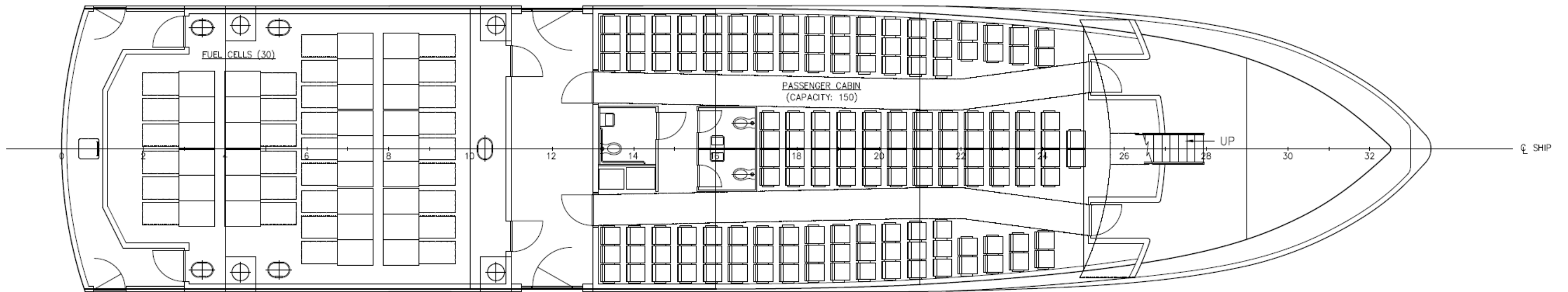

MAIN DECK ARRANGEMENT PLAN

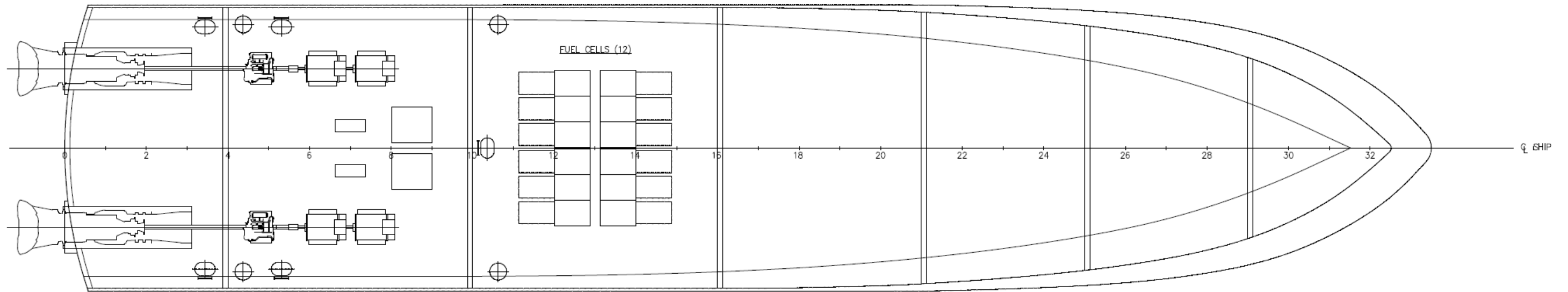

HOLD ARRANGEMENT PLAN

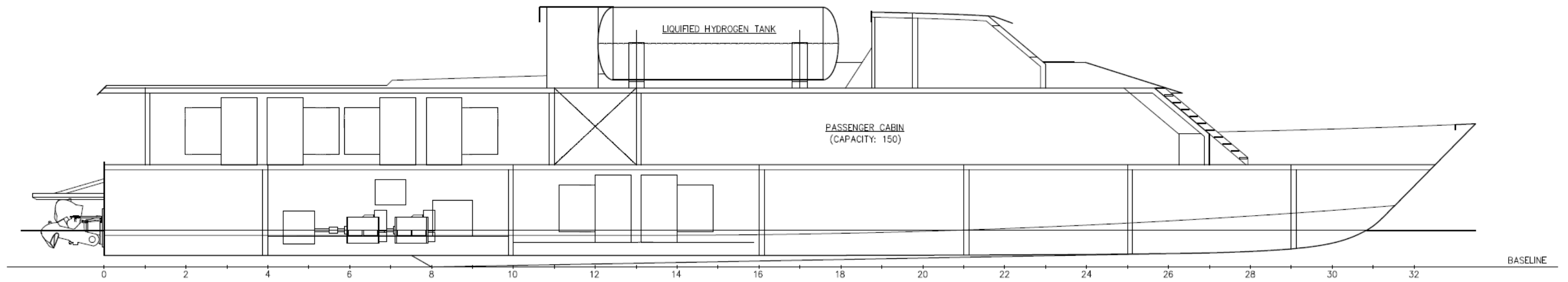

INBOARD PROFILE

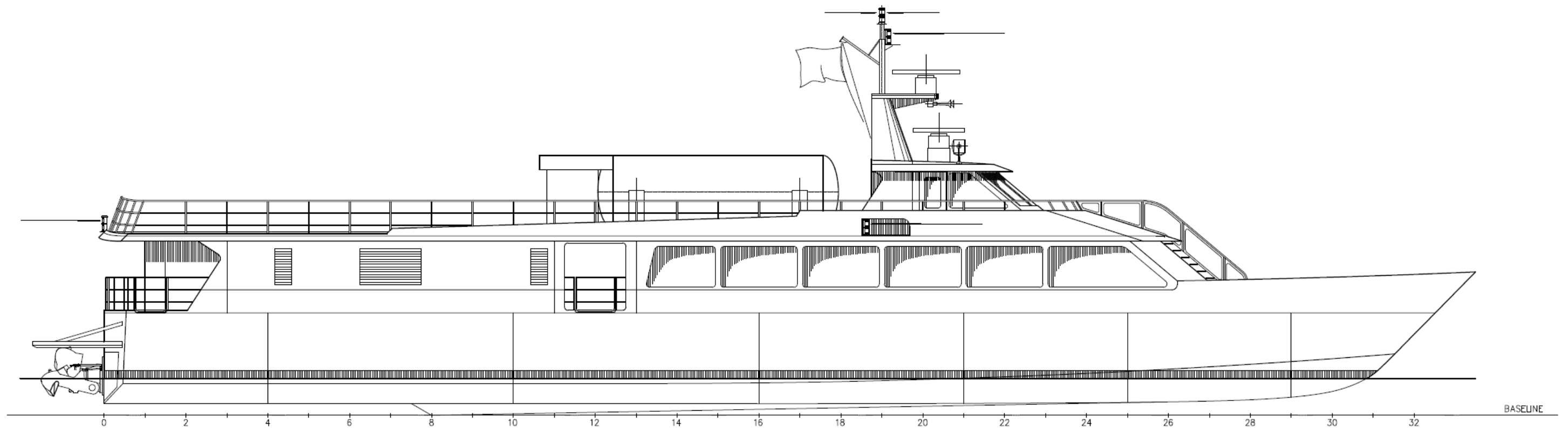

OUTBOARD PROFILE

Catamaran Drawings

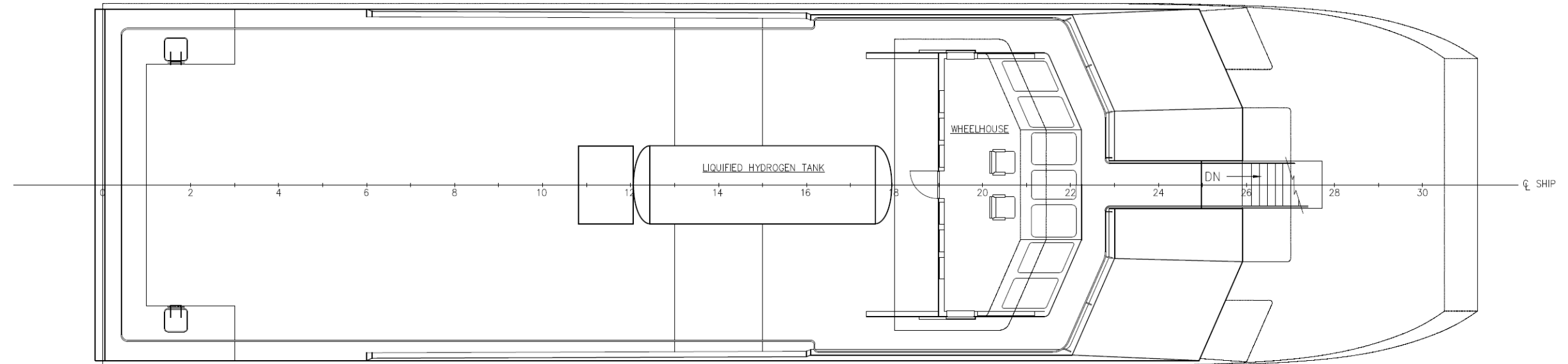

UPPER DECK ARRANGEMENT PLAN

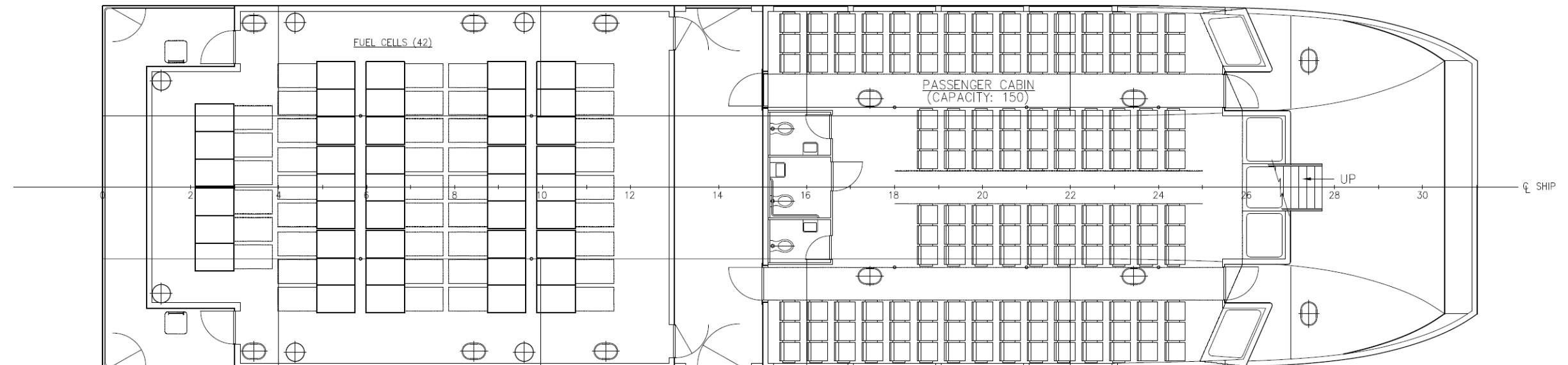

MAIN DECK ARRANGEMENT PLAN

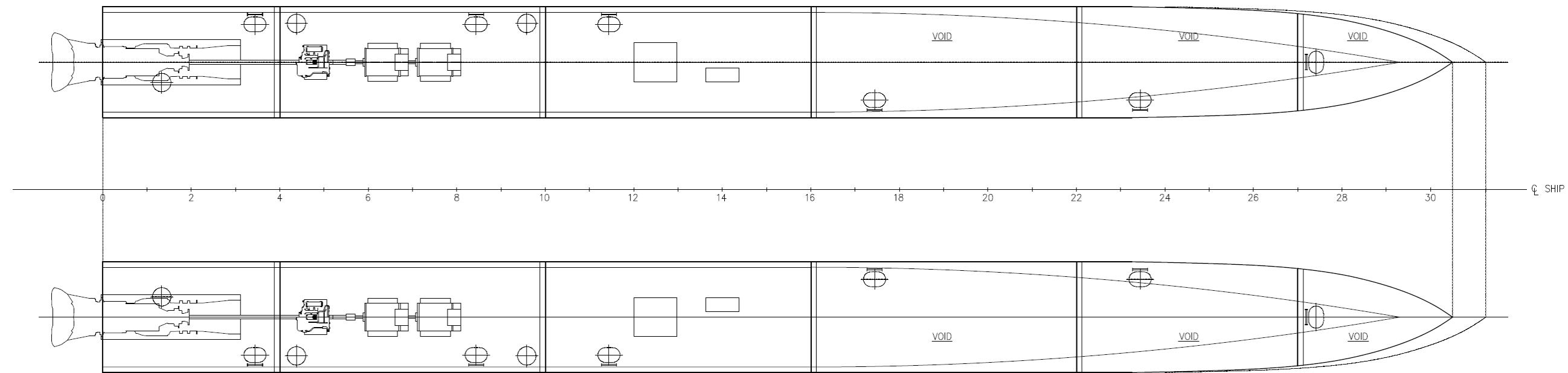

HOLD ARRANGEMENT PLAN

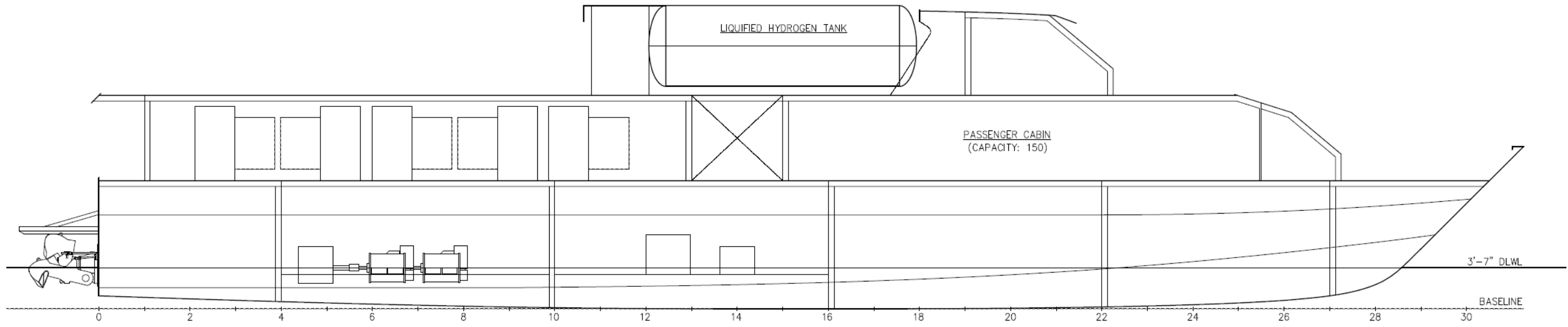

INBOARD PROFILE

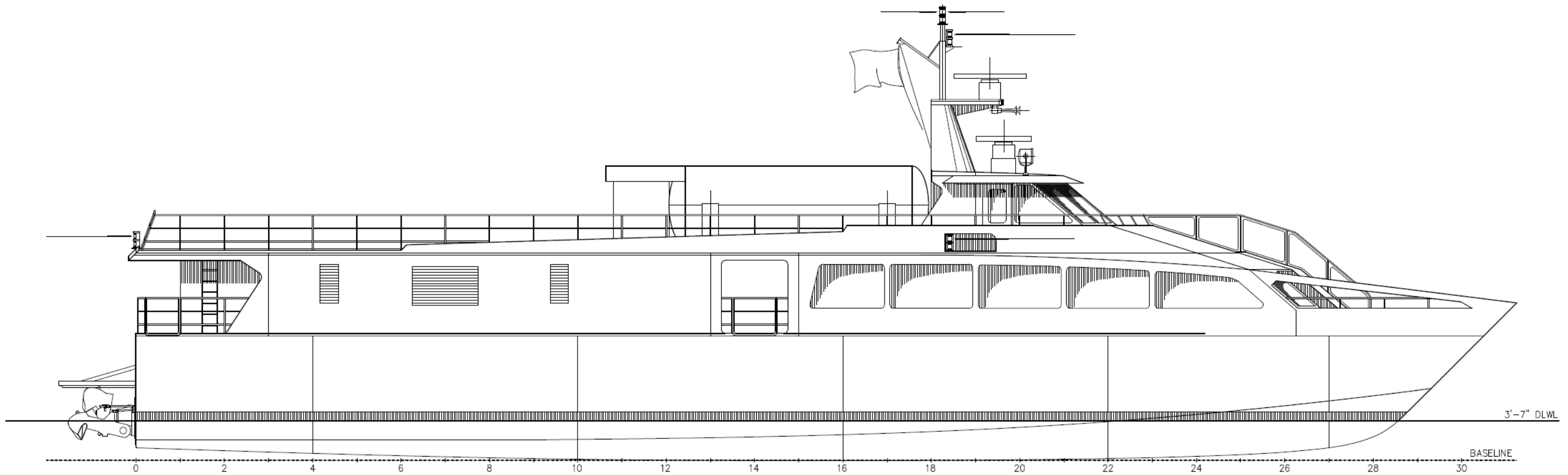

OUTBOARD PROFILE

Trimaran Drawings

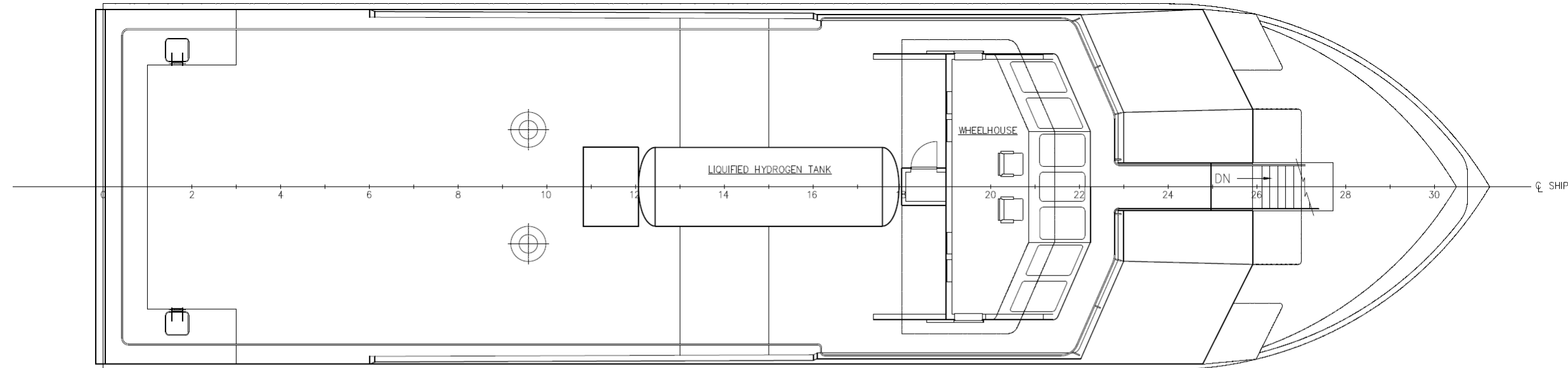

UPPER DECK ARRANGEMENT PLAN

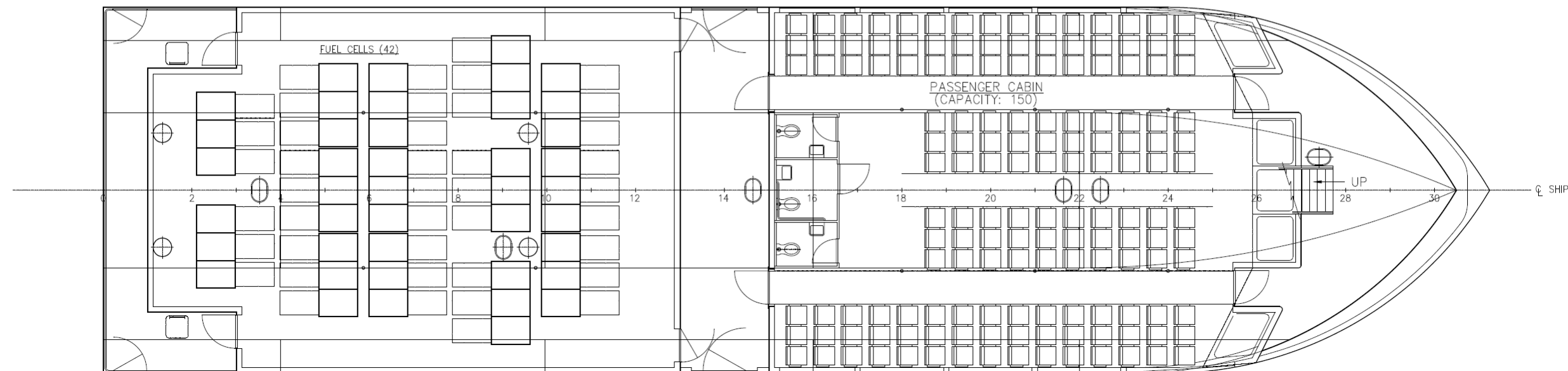

MAIN DECK ARRANGEMENT PLAN

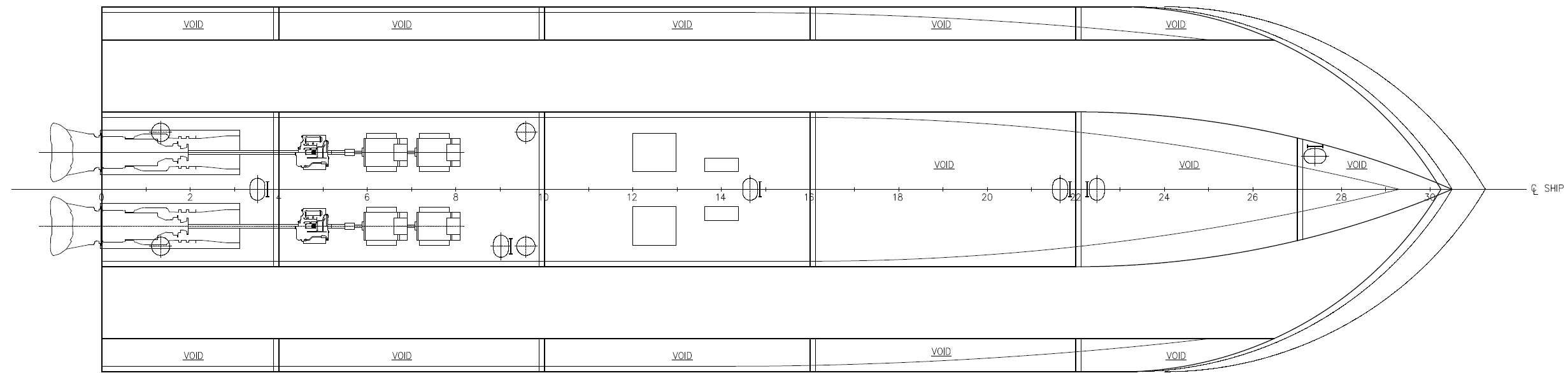

HOLD ARRANGEMENT PLAN

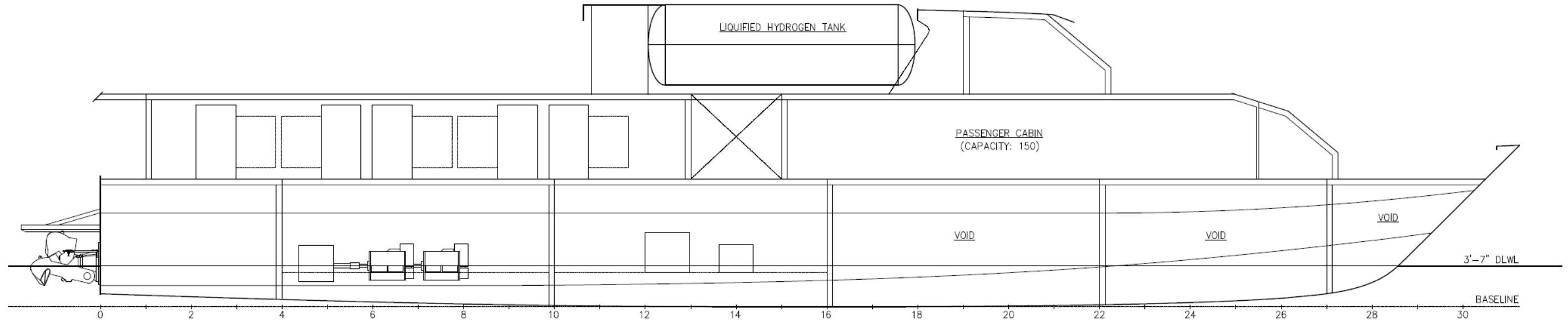

INBOARD PROFILE

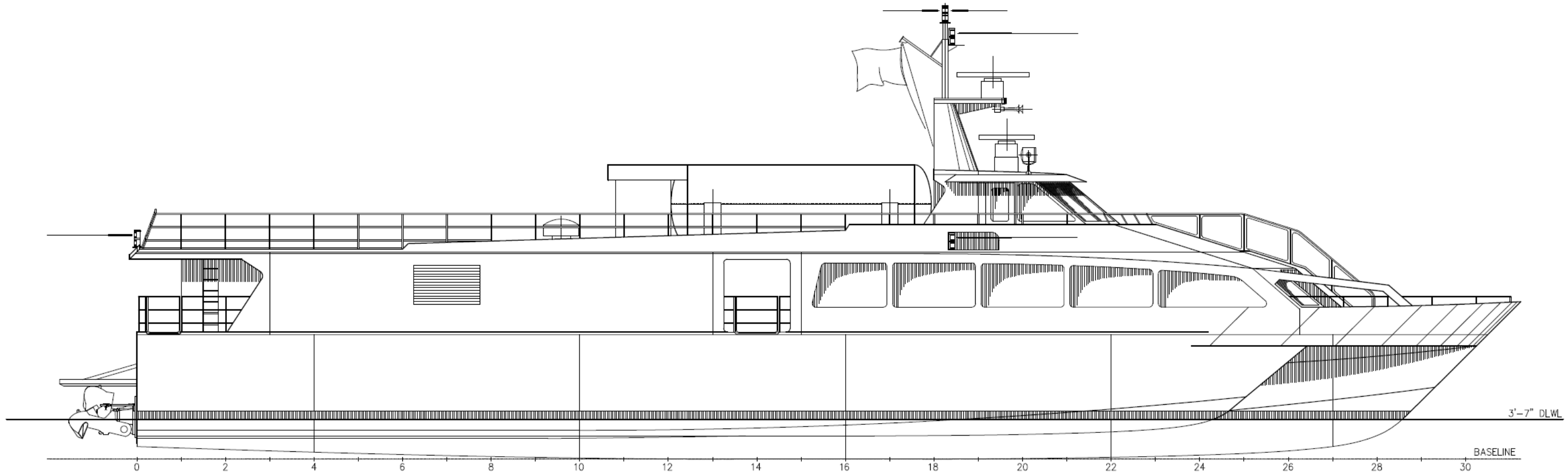

OUTBOARD PROFILE

CONFIDENTIAL AND PROPRIETARY PROPERTY OF
Elliott Bay Design Group LLC
 MAY NOT BE USED FOR CONSTRUCTION OR PROVIDED TO
 ANY THIRD PARTIES WITHOUT PRIOR WRITTEN CONSENT.
 ©2016 ELLIOTT BAY DESIGN GROUP.

REVISION HISTORY

REV	ZONE	DESCRIPTION	DWN	DATE	APVD
-----	------	-------------	-----	------	------

GENERAL NOTES

- THIS DRAWING IS PART OF A PRELIMINARY PACKAGE THAT HAS BEEN DEVELOPED TO THE CONCEPT LEVEL. IT IS NOT INTENDED FOR CONSTRUCTION AND HAS RESERVATIONS THAT WILL REQUIRE FURTHER DEVELOPMENT.
- THIS CONCEPT DESIGN HAS BEEN DESIGNED TO MEET THE STANDARDS, RULES AND REGULATIONS OF THE FOLLOWING PUBLICATIONS IN PART OR IN FULL: 46 CFR SUBCHAPTER T, ABS GUIDE FOR BUILDING AND CLASSING HIGH-SPEED CRAFT, RESOLUTION MSC.391(95) - ADOPTION OF THE INTERNATIONAL CODE OF SAFETY FOR SHIPS USING GASES OR OTHER LOW-FLASHPOINT FUELS (IGF CODE).

PRINCIPAL DIMENSIONS

LENGTH OVERALL:	109'-0"
LENGTH DESIGN LOAD WATERLINE:	99'-4"
BEAM:	33'-0"
DEPTH FROM MAIN DECK:	11'-3"
DRAFT TO DLWL (HULL):	55"
PASSENGER CAPACITY:	150
CREW:	4
LIQUEFIED HYDROGEN TANK CAPACITY:	4465 GAL (1200 kg)
SERVICE SPEED:	35 KNOTS
INSTALLED POWER (FUEL CELLS)	4.92 MW

REFERENCES

Elliott Bay Design Group
 Seattle • New Orleans • Ketchikan

CLIENT: **SANDIA NATIONAL LABORATORIES**
 LIVERMORE, CALIFORNIA

PROJECT: **SF-BREEZE FERRY FEASIBILITY STUDY**

GENERAL ARRANGEMENT

SIZE	D	DWG NO.	15051-001-101-1	REV	-
SCALE	3/16"=1'-0"	FILE NAME	15051-001-101-1-	SHEET	1 OF 3
DWN	REMc	MOD	EMT	CRD	CML
APVD	KTS	APVD DATE	2/12/16		

HALF SIZE PRINT

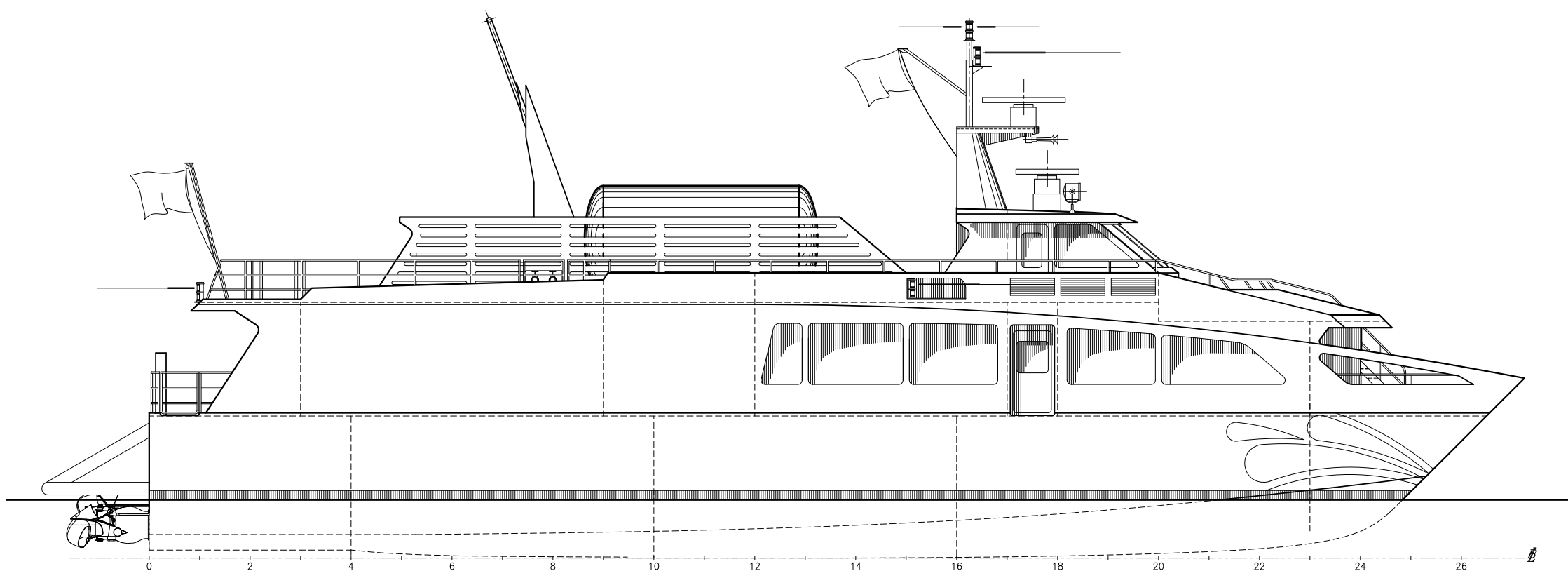

OUTBOARD PROFILE

CONFIDENTIAL AND PROPRIETARY PROPERTY OF
Elliott Bay Design Group LLC
 MAY NOT BE USED FOR CONSTRUCTION OR PROVIDED TO
 ANY THIRD PARTIES WITHOUT PRIOR WRITTEN CONSENT.
 ©2016 ELLIOTT BAY DESIGN GROUP.

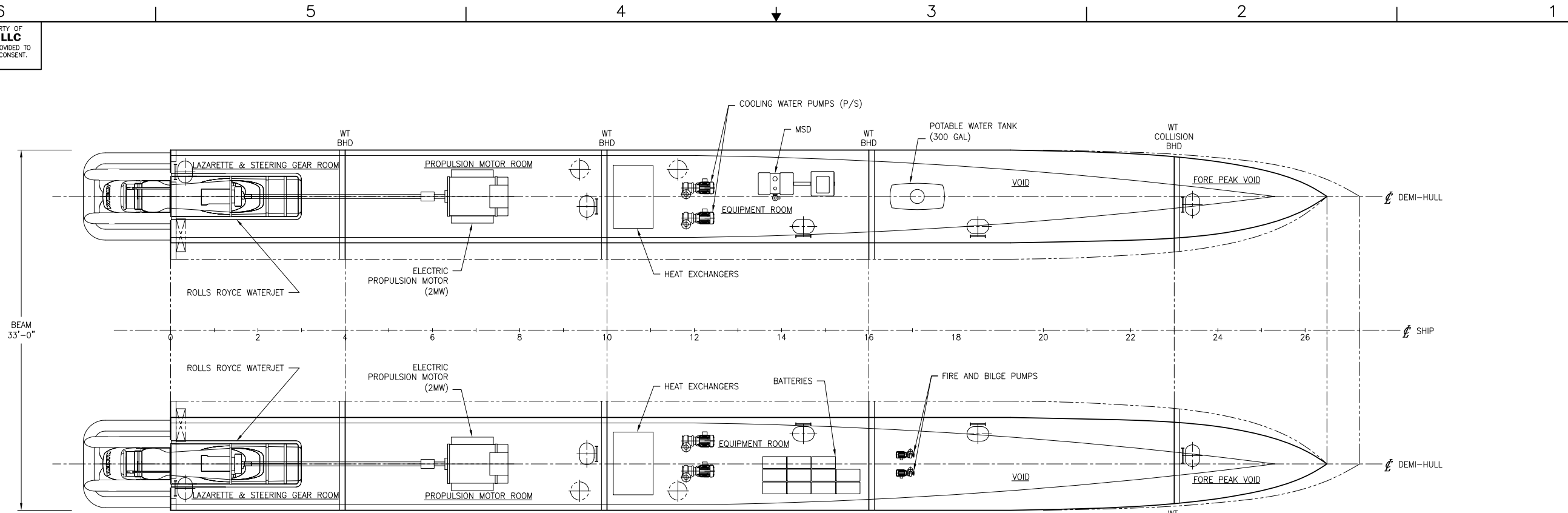

HOLD ARRANGEMENT PLAN

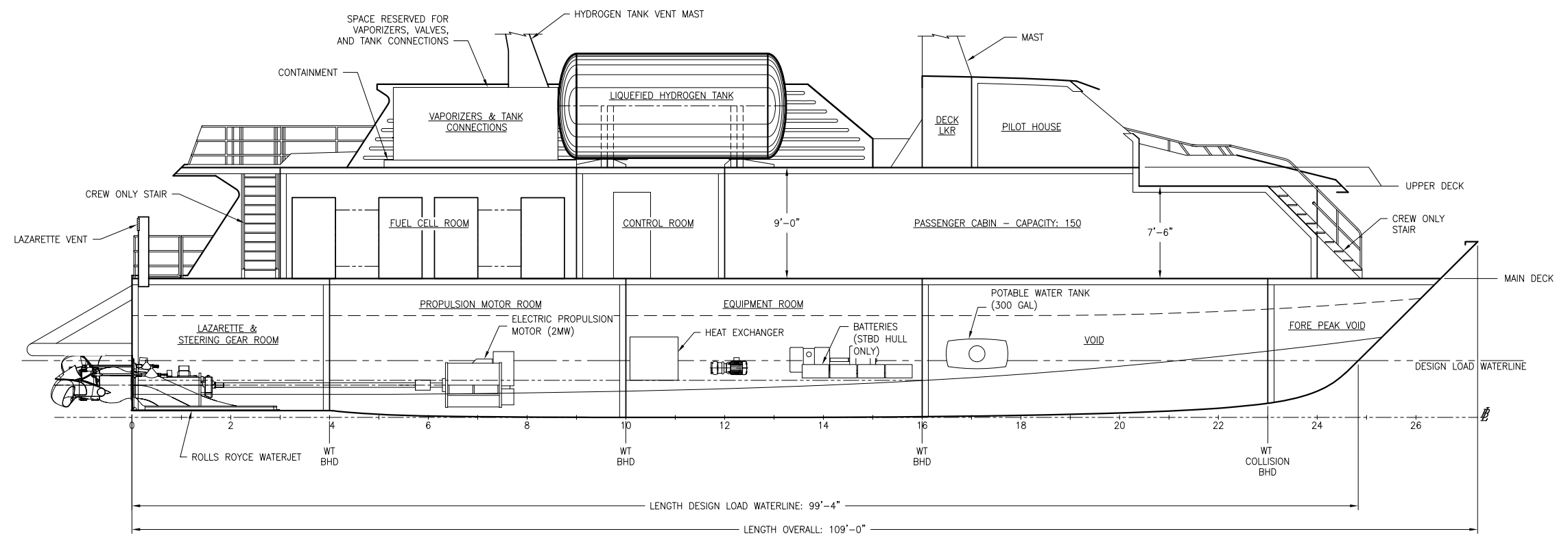

INBOARD PROFILE

STBD DEMI-HULL SHOWN, PORT DEMI-HULL SIMILAR
 FRAME SPACING: 48"



HALF SIZE PRINT

SIZE	D	DWG NO.	15051-001-101-1	REV	-
SCALE	3/16"=1'-0"	FILE NAME	15051-001-101-1-	SHEET	2 OF 3

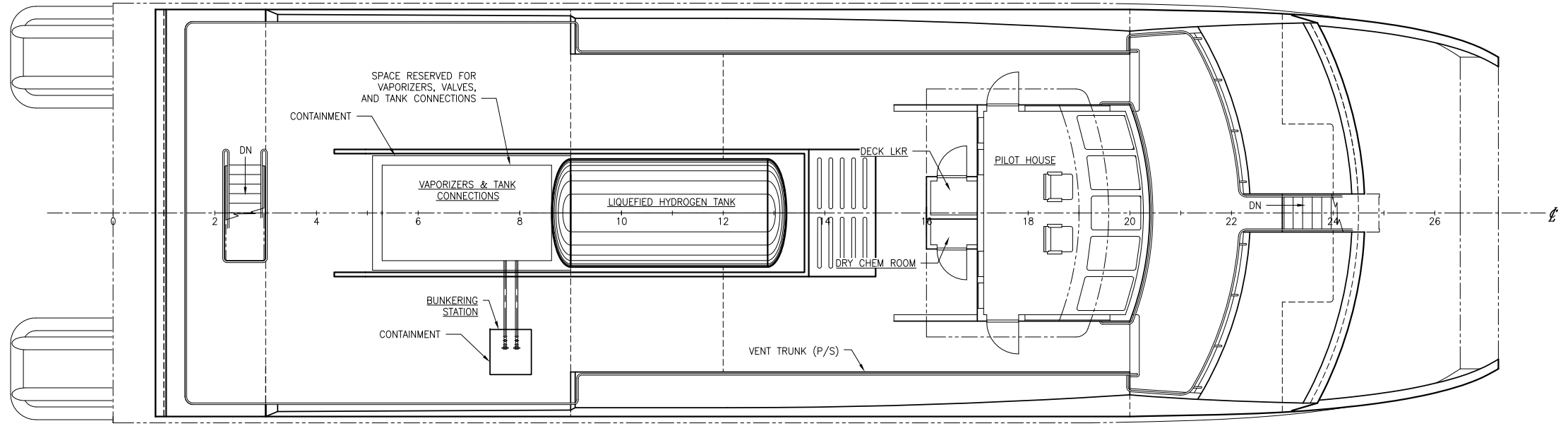

UPPER DECK ARRANGEMENT PLAN

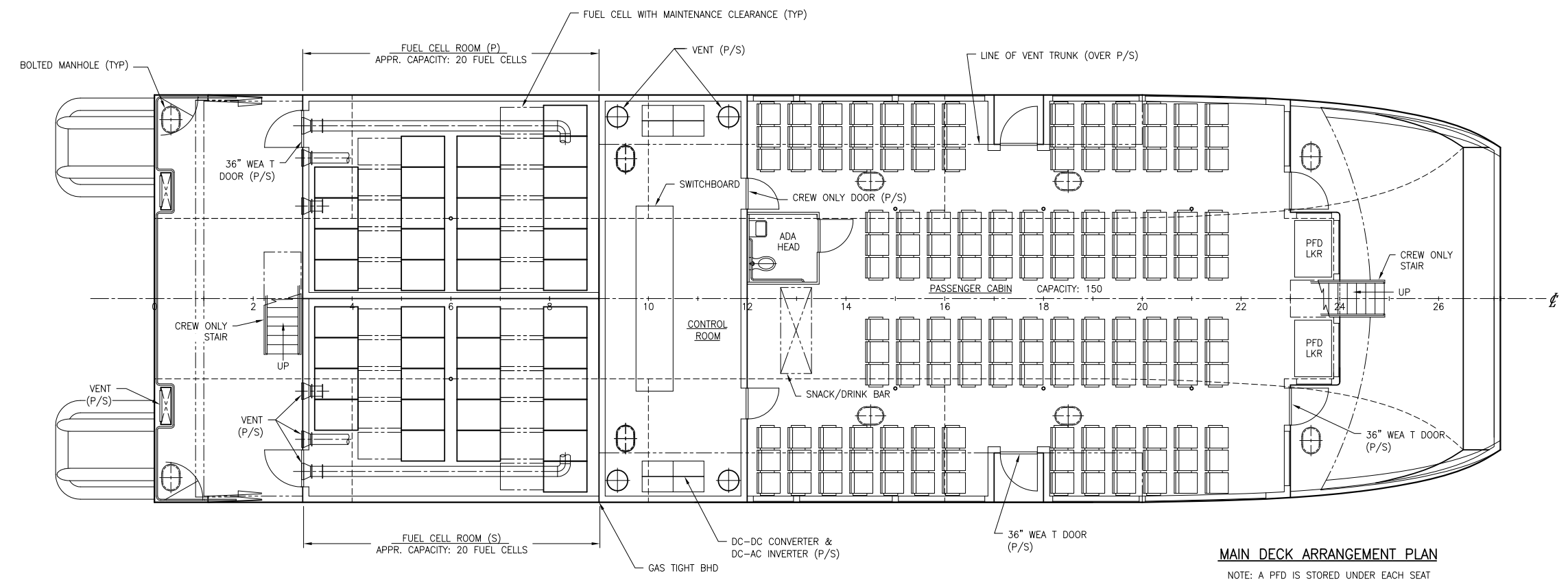

MAIN DECK ARRANGEMENT PLAN

NOTE: A PFD IS STORED UNDER EACH SEAT



HALF SIZE PRINT

SIZE	D	DWG NO.	15051-001-101-1	REV	-
SCALE	3/16"=1'-0"	FILE NAME	15051-001-101-1-	SHEET	3 OF 3



SF-BREEZE FERRY FEASIBILITY STUDY

Parametric Weight Estimate

Prepared for: Sandia National Laboratories • Livermore, CA

Ref: 15051-001-833-1

Rev. -

February 12, 2016

PREPARED BY

Elliott Bay Design Group
 5305 Shilshole Ave. NW, Ste. 100
 Seattle, WA 98107

GENERAL NOTES

1. Maintaining a strict weight budget is critical to the feasibility of the SF-BREEZE FERRY. Because this study is preliminary and for feasibility purposes, most of the weight items are not accounted for at a detailed level. Assumptions are made that weight control will be addressed during the detail design of the vessel. The weights presented in this report should, in general, be considered "not to be exceeded" in order to maintain confidence that the vessel will be able to make its intended design speed.

REVISIONS

REV	DESCRIPTION	DATE	APPROVED
P0	Preliminary Issue	1/21/16	KTS 48364
-	Initial Issue	2/12/16	KTS 48364

TABLE OF CONTENTS

	PAGE
1 Purpose	1
2 Procedure	1
2.1 Lightship Weight Estimation	1
2.2 Deadweight	3
3 Results	4
4 References	8

1 PURPOSE

This report describes the calculations and estimations used to determine the lightship weight and deadweight of the SF-BREEZE FERRY. The subject vessel is a 109 ft x 33 ft x 11.25 ft high speed catamaran passenger vessel which is powered by hydrogen fuel cells.

The weight estimate is one of the most important parts of the design of any type of vessel which is initiated at the beginning of the design and is constantly updated throughout the entire process. It is needed to determine how the vessel will float in the water, how stable the vessel will be, and how much power is needed to propel the vessel. In the case of high speed vessels such as this one, weight is an even more critical factor in determining required power, and the location of the vessel's center of gravity has a great impact on the required power as it affects the dynamic properties of the vessel at speed.

Lightship weight is defined as the weight of the vessel itself, not including the weight of passengers, fuel, fresh water, or any other consumable or cargo load that may be carried. Operating fluids are included and considered as part of lightship because they are necessary to the operation of the vessel.

Deadweight is the combined weight of all passengers, consumable loads, or cargo loads. The total fully loaded displacement, which is needed for speed and powering calculations, is the sum of lightship weight and deadweight.

2 PROCEDURE

2.1 Lightship Weight Estimation

Typically, a parametric weight estimate is performed by defining the vessel parameters such as length, beam, depth, draft, speed, and other coefficients of form along with other known characteristics such as hull material, number of passengers, range, et cetera. Using these parameters and known weights of existing vessels, it is possible to estimate the weights of the various systems and groups and arrive at a total vessel weight with a reasonable degree of accuracy.

The subject vessel required a slightly different approach for estimating certain systems because there are no existing high speed vessels with hydrogen fuel cell power plants.

To begin, a similar vessel with known weights and system characteristics was selected so that the weight groups could be appropriately modified to arrive at the group weights for the subject vessel. The vessel that was selected was the M/V VALLEJO a 103.5 ft x 28.5 ft x 8.8 ft high-speed aluminum catamaran commuter ferry which makes 33 knots. This vessel was selected for its similar size, speed, and because of the availability of good vessel data in house at EBDG. Other than the difference in propulsion systems, the only significant difference between the VALLEJO and the subject vessel is that the VALLEJO carries more passengers than the SF-BREEZE (300 vs. 150) and therefore, has a greater deckhouse weight for the additional accommodations.

Systems are often assumed to have a weight which is directly proportional to the product of the vessels main dimensions: length, beam and depth. Since this is a catamaran, demihull beam is

also an influential parameter as it affects the size of the hold and the quantity of hull structure. Aside from the main propulsion, fuel storage, related systems, and deadweight, the VALLEJO's known weights are multiplied by a scale factor which is proportional to the ratios of Length Overall (LOA), Beam, Demihull Beam, and Depth of the two vessels. This results in an overall scale factor of 1.10 on those systems.

Some lightship items on the VALLEJO related to the diesel propulsion systems were removed before the remaining weight was scaled by this factor. The items removed are:

- Main Diesel Engines
- Generator
- Cooling Systems and Fuel Systems
- Diesel Tank Structure
- Diesel Fuel Piping

The remaining weight was multiplied by 1.10, and given a 5% margin. Next, the weights of the hydrogen fuel systems were added to find the subject vessel's lightship weight. These items are:

- HD120 Hydrogen Fuel Cell Racks (qty 41)
- DC-DC converter and DC-AC inverter
- Electric Motors
- Cooling Systems and Fuel Systems (detailed weight estimate performed specific to fuel cell requirements)
- Liquid Hydrogen Fuel Storage Tank
- Liquid Hydrogen Vaporizers
- Other electrical components (applied as a 30% margin on fuel cell weight)
- Batteries

Note that while 41 fuel cells racks are required to provide the necessary installed power, there are only 40 shown in the General Arrangement [1]. It is assumed that through customization of the fuel cell racks that it will be possible to include slightly more fuel cell power in the available space.

It was determined that the RPM of the electric motors will likely allow a direct coupling to the waterjet propulsor without use of a reduction gear, so the weight of the reduction gear was removed from the parametric weight value after it was scaled.

Certain items were identified that would be heavier on the subject vessel than the VALLEJO which were not specifically addressed. Some of these items include structural fire protection, or increased structure to support the liquid hydrogen tank on the Upper Deck. These increases in superstructure weight are assumed to be more than offset by the relative reduction of the superstructure weight owing to the fact that less structure and accommodations will be needed for the lower passenger count. The total deck of the two superstructure decks of the SF-BREEZE is less than that of the VALLEJO.

2.2 Deadweight

Vessel deadweight is calculated as the weight of 150 passengers +4 crew (185 lb each), 1200 kg of liquid hydrogen, and 1 long ton of freshwater.

3 RESULTS

The vessel weights are as follows:

Table 1: Vessel Weight Summary

Weight Item	Weight (1 LT = 2240 lb.)	Longitudinal Center of Gravity (LCG), ft forward of transom
Lightship Weight:	118.1 LT	37.3
Deadweight:	14.9 LT	68.6
Fully Loaded Weight:	133.0 LT	40.9

Table 2: Weight Estimate

SWBS No.	Description	Qty.	Unit	Unit Wt. (lb)	Total Wt. (lb)	Margin	LCG (ft)	Source C, E, V	Notes
100					105,697	5%	46.00		
200 (excluding Fuel Cells)					81,409	0%	34.43		
200 (Fuel Cells)					54,243	0%	24.58		
300					17,967	0%	34.45		
400	included in Group 100					0%			
500	included in Group 100					0%			
600	included in Group 100					0%			
700						0%			
DWT					33,376	0%	69.64		
Subgroup-based Margin Total					5,285	0%	46.00		
Item-based Margin Total					-	0%			
Group Total W/ Margin					297,977	3%	40.89		

100.0 Parametric Weight Item									
									Includes structure, all outfit, navigation, nominal red. gear, waterjet. <u>Engine Egen. and associated machy removed from this value.</u> Scaled from Vallejo based on cubic number from overall dimensions. Vallejo has 2 decks, but they are shorter. Superstructure and outfit weight should be similar.
100.0	Parametric Weight Item	1		120904	105,697		46.00		
200.0 Mechanical Systems									
230.0 Propulsion									
231.0	Fuel Cells	41		1323	54,243		24.58		120 kW HyPM Rack, Hydrogenics
231.1	DC-DC converter	4		397	1,587		43.00		chassis CH64 p 144 of Vacon catalog
231.2	DC-AC inverter	4		397	1,587		43.00		chassis CH64 p 144 of Vacon catalog
231.3	filter	1		200	200		43.00		estimate
231.4	line reactor	1		1000	1,000		43.00		estimate
232.0	Electric motors	2		13224	26,448		28.00		Obeki permanent magnet motors
233.0	Reduction Gears	-2		2400	(4,800)		25.00		Deducted from baseline weight
234.0	Waterjets	2		5204	10,408		6.30		Rolls Royce A3-63 dry weight
256.0 Cooling Systems									
256.0	Fuel Cell Heat Exchangers	2		1200	2,400		46.00		Wt taken from AK class heat exchanger, similar size
256.0	SW cooling pipe	16		6.68	107		46.00		estimate
256.0	SW valves	4		30.00	120		46.00		estimate
256.0	6" FW Cooling Pipe	72		6.68	481		46.00		estimate
256.0	3" Fuel Cell Cooling Pipe	840		2.67	2,242		46.00		estimate
256.0	6" Supply Manifold	2		1827	3,654		46.00		estimate
256.0	6" Return Manifold	2		1827	3,654		46.00		estimate
256.0	Seawater Pump	2		500	1,000		46.00		AK class pump weight
256.0	Cooling Water Pump	2		500	1,000		46.00		AK class pump weight
256.0	operating fluids	1		1000	1,000		46.00		estimate
260.0 Fuel Systems (Incl LH2, tank, vaporizer)									
261.0	LH2 tank	1		23020	23,020		43.75		based on 8.7x fuel weight factor from Sandia piping from tank to vaporizer, vaporizer to fuel cells
262.0	Piping	1		2302	2,302		31.92		
263.0	Vaporizer	2		2000	4,000		31.92		Thermax cryogenic vaporizer
200.0	Sum (w/o Fuel Cells & Tank)				81,409				

300.0	Electrical					
						30% of fuel cell weight, covers wiring and switchboard (some electrical components in section 230)
304.0	Electrical Margin	30%	54,243	16,273	32.00	
313.0	Batteries					
	Corvus AT6500-125-96	11	154	1,694	58.00	Selected because of nominal voltage of 88.8 (max 100.8) x 11 ~1000V
300.0	Sum			17,967		
400.0	Command and Surveillance					
	included in 100.0 "Parametric Weight Item"					see group 100 note
500.0	Auxiliary Systems					
	included in 100.0 "Parametric Weight Item"					see group 100 note
600.0	Outfit					
	included in 100.0 "Parametric Weight Item"					see group 100 note
	Deadweight					
	Passengers	150	185	27,750	70.60	
	Crew	4	185	740	70.60	
	LH2 fuel	1	2646	2,646	43.75	
	Water	1	2240	2,240	88.00	approximately 300 gallons
	Sum			33,376		

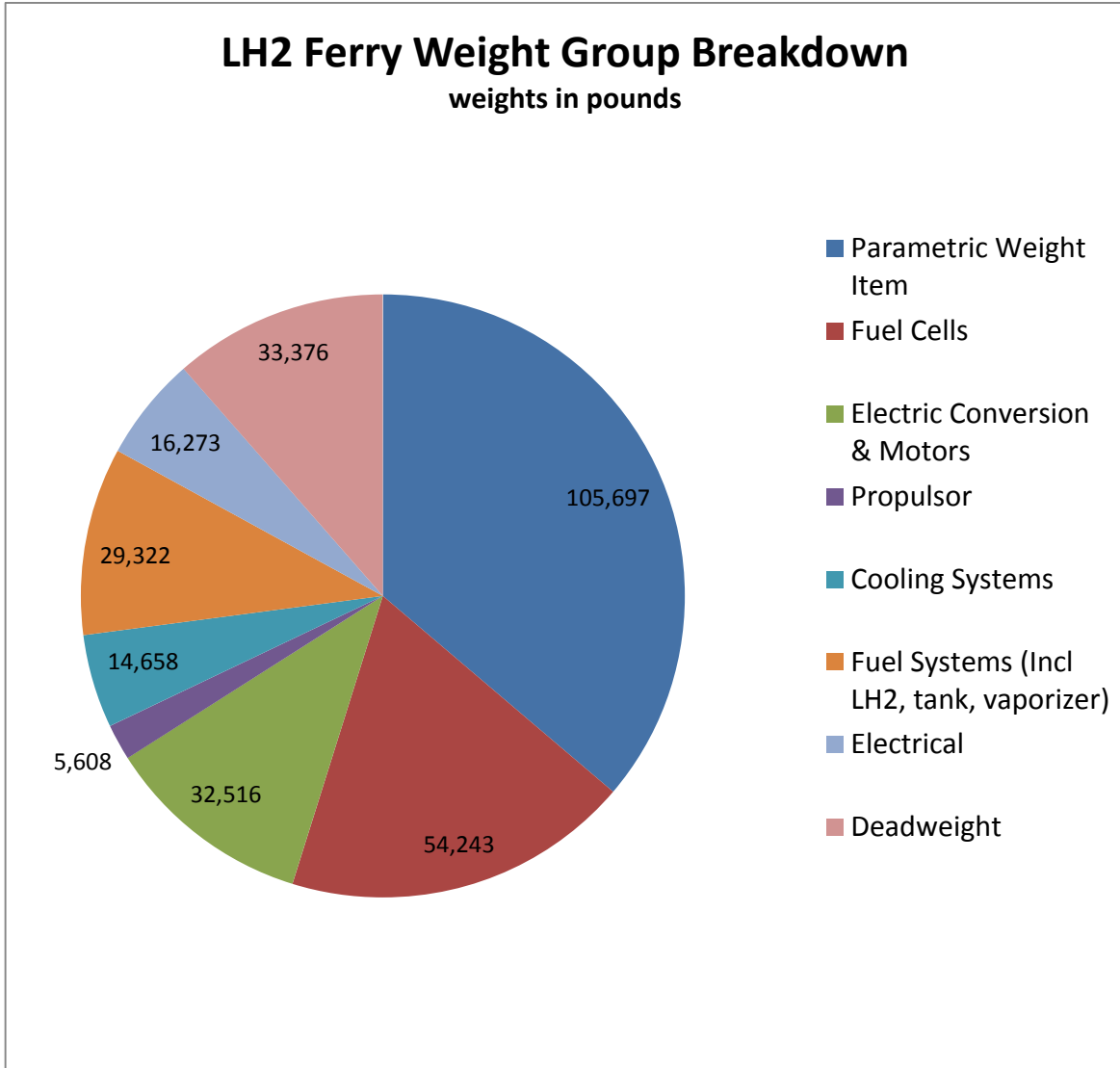

Figure 1: Weight Group Breakdown

4 REFERENCES

- [1] Elliott Bay Design Group, "General Arrangement," 15051-001-101-1-, Seattle, WA, February 12, 2016.



SF-BREEZE FERRY FEASIBILITY STUDY

Speed and Powering Calculations

Prepared for: Sandia National Laboratories • Livermore, CA

Ref: 15051-001-050-0

Rev. -

February 12, 2016

PREPARED BY

Elliott Bay Design Group
5305 Shilshole Ave. NW, Ste. 100
Seattle, WA 98107

REVISIONS

REV	DESCRIPTION	DATE	APPROVED
P1	Preliminary Issue	1/21/16	KTS 48364
-	Initial Issue	2/12/16	KTS 48364

TABLE OF CONTENTS

	PAGE
1 Purpose	1
2 Procedure	1
2.1 Software	1
2.2 Vessel Weight and Center	1
2.3 Prediction Method	2
2.3.1 Savitsky	2
2.3.2 Speed "Hump"	2
2.3.3 Margins	4
2.3.4 Prediction Alignment	4
2.3.5 Effective Horsepower	4
2.3.6 Overall Propulsive Coefficient	4
3 Results	5
3.1 Effective Horsepower	5
3.2 Overall Propulsive Coefficient	6
3.3 Installed Horsepower	6
4 Future Work	7
5 References	9
6 Calculations	10

1 PURPOSE

The purpose of this report is to describe the speed and powering calculations performed on the SF-BREEZE High Speed Hydrogen Ferry. The vessel is a high-speed planing catamaran with dimensions of 109 ft x 33 ft x 11.25 ft, and an overall height above the waterline of about 38.25 ft. The intended route is on San Francisco Bay servicing daily commuters to and from the downtown area.

Speed and power calculations are critical because the required power determines the required number of fuel cells, which are expensive as compared with a conventional diesel configuration. The cost of the hydrogen fuel cells is the largest impact on the economic viability of the vessel.

2 PROCEDURE

2.1 Software

For these speed and powering calculations, NavCad 2015 software was used. NavCad is a software package which makes resistance and powering predictions based on specified vessel parameters. NavCad uses many well-vetted systematic model test series for which the results have had regression analyses performed. Tools are provided in the software to select the best series regression so that vessel parameters can be input and used to predict performance using that regression.

2.2 Vessel Weight and Center

The weight estimate that was produced by Elliott Bay Design Group (EBDG) [1] contains some parametric values, and some vendor supplied values. Since a high speed planing vessel is sensitive to weight as compared with slower vessels, it was necessary to gain a higher level of confidence in certain significant weight items. The estimated weights of the vessel are described in Table 1.

Table 1: Vessel Weights

Weight Item	Weight (1 LT = 2240 lb.)	Longitudinal Center of Gravity (LCG), ft forward of transom
Lightship Weight:	118.1 LT	37.3
Deadweight:	14.9 LT	68.6
Fully Loaded Weight:	133.0 LT	40.9

Lightship weight is defined as the weight of the vessel itself not including any fuel, passengers, potable water, or other cargo. Deadweight is defined as the weight of all of those consumable/removable items just stated which are not part of lightship. The weight per passenger is assumed to be 185 lb/person which is a typical assumption based on the latest data provided by the US Center for Disease Control which has been adopted into guidelines used by the US Coast Guard. This value does not include a margin for effects or baggage, as it is assumed that daily commuters carry minimal extra items. The fully loaded weight is the sum of Lightship Weight and Deadweight.

Vertical center of gravity (VCG) was not calculated because catamaran stability is sufficient for high VCG values. The transverse center of gravity (TCG) is assumed to be on the vessel centerline (zero).

Typically, when detailed weight estimates are performed, a weight margin is included to account for unknowns and for items that were neglected from the calculation. In theory, a parametric weight estimate should be less subject to suffering from inaccuracy due to items being neglected because it is a representation of the final weight of the vessel based on final known weights of similar vessels. Since the majority of the weight items in the weight estimate were accounted for by using parametric methods or vendor supplied values (particularly hull, auxiliary, and fuel cell weights), an overall weight design margin was not included. Careful weight control during detail design will be critical to the feasibility of the vessel.

2.3 Prediction Method

2.3.1 Savitsky

For this analysis, the Savitsky planing method was used. Daniel Savitsky's definitive 1964 paper, "Hydrodynamic Design of Planing Hulls" [2] has received wide use and validation and has been further adapted to more specific scenarios and hullform variations. The Savitsky method is not itself a test series, but rather a series of iterative force-balance equations which account for all static and dynamic effects acting on a hull during steady planing. Of the planing prediction methods available in NavCad, Savitsky was the most applicable due to the slenderness of the hullform and the relatively further aft longitudinal center of gravity (LCG). For the other series, these parameters resulted in the prediction being, at best, at the extreme range of the parameters that would give accurate results. Savitsky, which is a more "general" prediction method for planing hulls, is appropriate for preliminary design work and parameters that have not yet been refined.

2.3.2 Speed "Hump"

The subject vessel is at the low end of the speed range that is considered planing for a vessel of this size. As a vessel speed increases from slower "displacement" speeds (speeds at which the positive vertical forces are dominated by the buoyant forces acting on the vessel) to higher "planing" speeds (speeds at which the positive vertical forces are dominated by dynamic lift caused by the vessel moving through water), the vessel must typically pass through a "hump" region. On a curve of vessel resistance vs. speed, the hump region is a standout region where the total drag is relatively higher than the rest of the curve trend would suggest (See Figure 1). Once the vessel reaches a certain speed, it is actually possible for the total drag to drop a bit, however, for vessels such as the subject of this study with a high slenderness ratio, the drag is not likely to drop. This region following the hump is the target speed for planing vessels. Since the subject vessel is not fully out of the hump region at 35 knots, a correction factor is applied to include additional hump resistance which was not accounted for in Savitsky 1964. Donald Blount and David Fox produced a formulaic correction to account for hump drag in their 1974 paper, "Small-Craft Power Prediction" [3]. This correction was further adjusted by Blount and Bartee in the 1997 paper, "Design of Propulsion Systems for High-Speed Craft" [4] to apply a 0.5 correction factor to the hump speed correction for most vessels, as the full correction factor "tends to favor resistance predictions for heavy, beamy craft". This would suggest that applying

a half correction factor is more appropriate, and, since the catamaran hullform is quite slender, even the half correction factor may be conservative.

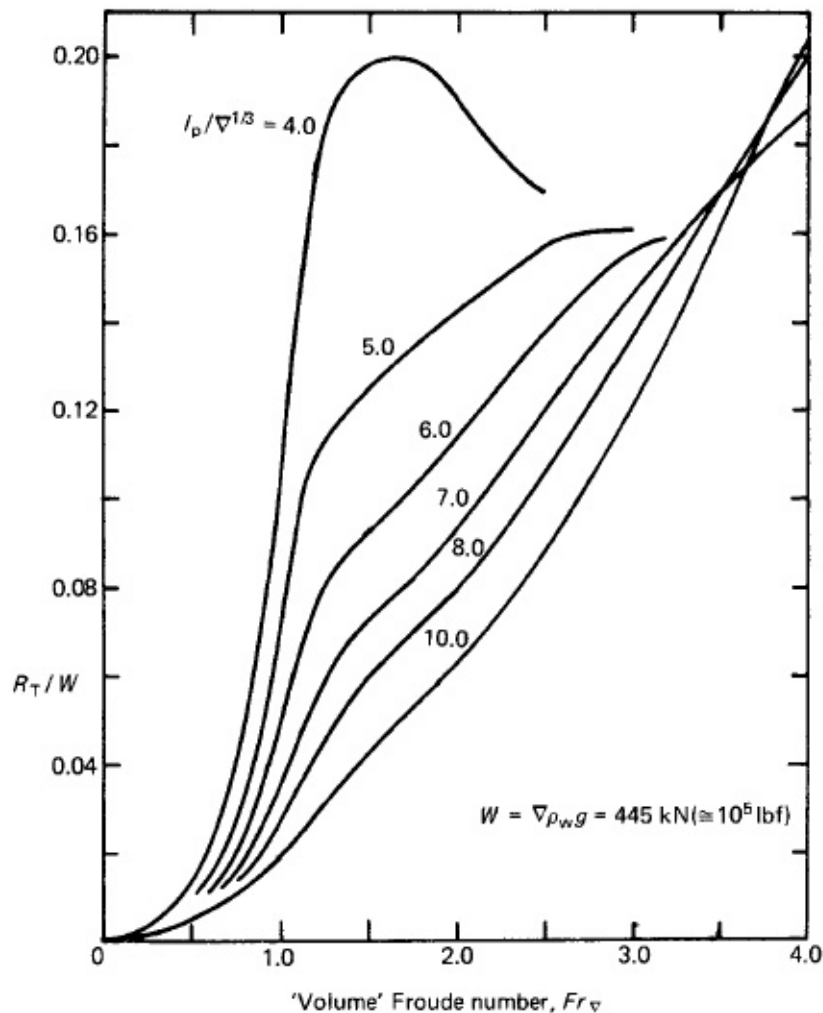

Figure 1: Effect of Length/Displacement Ratio on "Hump" Characteristics

The Savitsky method does not have specific methodology for catamarans, so the accepted adjustment for a twin-hull vessel is to perform the calculation for one demihull, multiply the resistance by 2, and apply a wake "interference" factor. The catamaran interference factor is internally calculated in NavCad per Sherman and Fisher's 1975 paper "A Study of Planing Catamaran Hull and Tunnel Interactions" [5]. The bare hull resistance value presented in the results includes the interference factor adjustment.

A commonly used appendage on high speed catamarans is a "transom lift device". Several types of transom lift devices are available, but all serve to reduce vessel drag by lifting the stern upward and reduce running trim angle, and total wetted surface. When running trim angle is reduced, then the flat of the bottom of the hull is better aligned with the direction of travel, and the required power to make speed is reduced. NavCad has functions to estimate the reduction in

horsepower that could be realized by use of a lifting device, and predicts as much as a 10% reduction. However, since transom lifting device design requires more detailed hydrodynamic analysis, this reduction is not included in the analysis. The fact that the lifting device is not included in the analysis could be considered as a design margin of 5-10% since they are very commonly used and would almost certainly provide a significant benefit to the subject vessel. This is particularly true since this vessel has an LCG that is rather far aft, and would likely have a high running trim angle without corrections. While the potential benefit of the lifting device is significant, the actual benefit would require much analysis to determine. Therefore, the possible reduction in drag is not included in this analysis.

2.3.3 Margins

To apply a margin for head winds, the Taylor method [6] was applied in NavCad. A head wind speed of 13.5 knots was applied and calculated to increase drag on the vessel by about 11%.

No seas margins were applied. No additional margins on drag were applied. The vessel is assumed to have zero appendage drag as it utilizes waterjet propulsion.

It was decided by the project team that the target design power margin should be around 10%.

2.3.4 Prediction Alignment

Before the resistance prediction was performed for the subject vessel, the high speed diesel catamaran M/V VALLEJO was used to validate the prediction method. The VALLEJO is a vessel with known parameters, installed power, and similar proportions to the subject vessel. It is known to EBDG that the VALLEJO runs at full engine power during operation. Using similar prediction settings as those that are applied to the subject vessel, the VALLEJO was predicted to be able to make a top speed of 33 knots. Using satellite Automatic Identification System (AIS) GPS data on marinetraffic.com, it was verified that the VALLEJO routinely makes about 33 knots top speed.

2.3.5 Effective Horsepower

Effective horsepower (EHP) is defined as the power required to drive the vessel through the water at a given speed, as opposed to the power available at the output of the power plant. In other words, much of the power available at the motor shaft ("brake" horsepower, or BHP) is reduced due to mechanical and hydrodynamic losses, and the remaining power available to move the vessel is the EHP. NavCad is used to internally solve for vessel drag and EHP as a function of vessel speed. See the Calculations section for detailed NavCad output.

2.3.6 Overall Propulsive Coefficient

In order to determine how much power needs to be installed in the vessel to make speed, the Overall Propulsive Coefficient (OPC) must be calculated. The OPC is the ratio of EHP to BHP and describes all mechanical, hydrodynamic, and aerodynamic losses experience by the vessel. The EHP derived in NavCad is divided by the OPC to calculate the required BHP. Following is a list of the losses in power in the systems which are estimated individually using various sources or methods.

1. Propulsive Coefficient (C_p) – This value represents the losses in the propulsor (such as a propeller or waterjet).
2. Motor Efficiency (η_{Motor}) – This value represents electrical losses in the motor.
3. Electrical Losses in AC Inverter (η_{AC})
4. Electrical Losses in DC Converter (η_{DC})
5. Mechanical Losses (η_M). – Shaft bearing and/or mechanical gear losses.

$$OPC = C_p * \eta_{Motor} * \eta_{AC} * \eta_{DC} * \eta_M$$

$$BHP = \frac{EHP}{OPC}$$

The BHP result is used to determine the required quantity of fuel cells. The total power of the fuel cells must exceed the BHP in order for the vessel to be able to make speed.

The fuel cells that provide power are quite heavy, so as more were added, the power requirements also increased. It was necessary to iterate to find the number of fuel cells required (along with a reasonable margin) to be able to make speed.

3 RESULTS

3.1 Effective Horsepower

The effective horsepower computed by NavCad at 35 knots is 2.59 MW. See the Calculations section for detailed output from NavCad which includes hull parameters, calculation methodology, environmental assumptions, and detailed tabular results.

3.2 Overall Propulsive Coefficient

Table 2: Calculation of the OPC

Item	Efficiency %	Description
Propulsive Coefficient (C_p)	0.668 ¹	Rolls-Royce Kamewa 63A3 at 35 knots.
Motor Efficiency (η_{Motor})	0.968	Based on a 1 MW Permanent Magnet Motor [7]
AC Inverter Efficiency (η_{AC})	0.97	Estimate, provided by Vacon [8]
DC Converter Efficiency (η_{DC})	0.97	Estimate, provided by Vacon [8]
Mechanical Losses (η_{M})	0.97	Typical estimate for Diesel mechanical systems.
Overall Propulsive Coefficient	0.59	

3.3 Installed Horsepower

The required installed horsepower is approximately 4.39 MW. Other ship loads are estimated at 120 kW, which results in a maximum power demand of 4.51 MW. It was decided during discussions that 4.92 MW (41 racks of 120 kW) would be the design installed horsepower, which provides a 9% design margin. Currently, 40 racks of 120 kW fuel cells are shown in the General Arrangement [9] which only provide 4.8 kW of power. Each rack contains 4x30 kW fuel cells for a total of 120kW, and it is assumed that through further optimization of the fuel cell rack construction (e.g. 5x30 kW Fuel Cells per rack rather than 4x30 kW) that the additional power will be able to be installed in the available space in the fuel cell rooms.

¹ Efficiency is for the described waterjet model. Preliminary findings indicate that a Voith Linear Jet may slightly outperform the waterjet in terms of efficiency, but because of other design nuances such as gears/rudders, possible increased weight, and potential for debris strikes, the waterjet was used in all calculations.

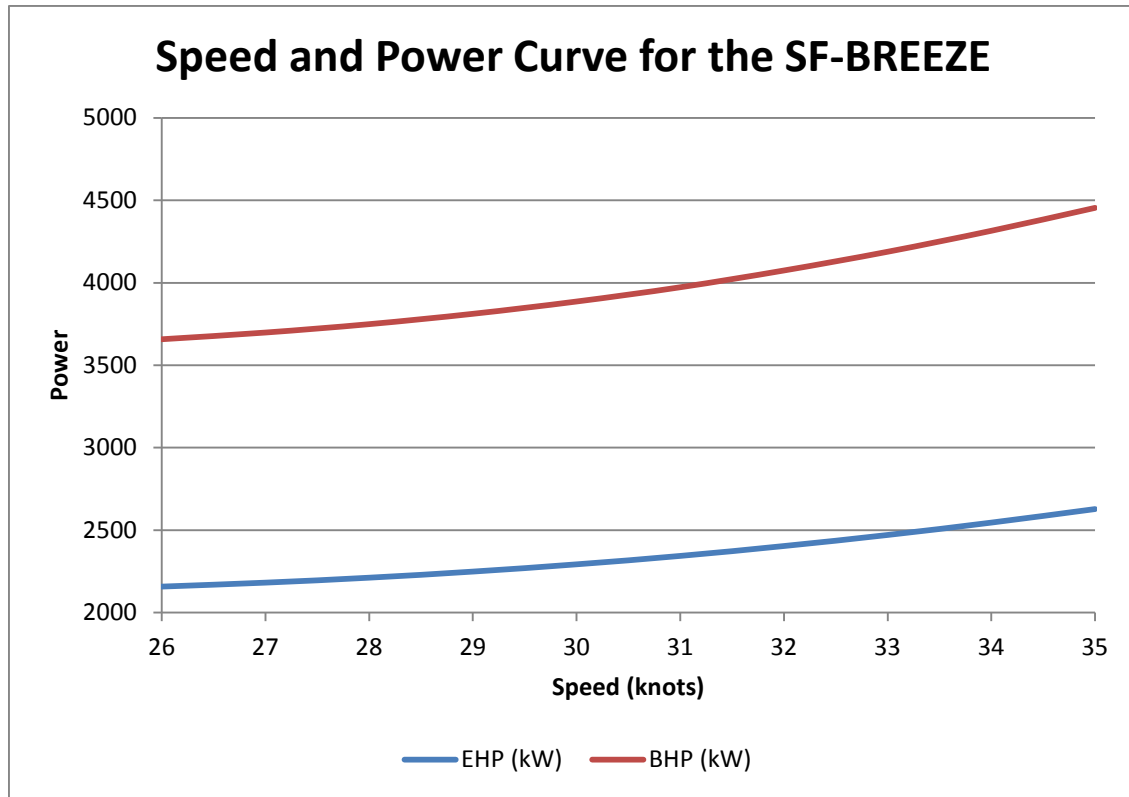

Figure 2: Resulting NavCad EHP and BHP results as a function of vessel speed

4 FUTURE WORK

These calculations are based on approximate parameters of hull form, weight, route length, and required speed. Though the calculations in this report demonstrate feasibility of the design, there is much work needed to arrive at a more refined prediction of speed and powering requirements. The current estimated lightship and fully loaded weight should be considered a "not to be exceeded" value in terms of the feasibility of progressing with the vessel design.

The biggest unknown is weight. Systems in the weight estimate [1] were calculated using parametric methods or using vendor supplied information. Detailed weight estimates would need to be performed for groups such as hull structure, piping, electrical, outfit, and auxiliary systems to gain more confidence in those values. Systems for which vendor supplied information, such as the fuel cells, electric motors, AC/DC power conversion, propulsors, and other major components, use exact weights, however, it is nearly certain that during the detail design phase that at least some of these equipment selections could change. In particular, the weight of the fuel cells could change because there are not any existing shipboard installations of such a large quantity of fuel cell power that have been optimized for weight.

The sensitivity of the vessel power to weight changes amounts to approximately a 1.1% change in required power for a 1% change in weight. For example, if the vessel weight were increased by 1,000 lb, an additional 16 kW of power would be needed to maintain 35 knots, or if the weight increased by 7,500 lb, one additional 120 kW fuel cell rack would be needed. A single

120 kW fuel cell rack provides 2.4% of the installed power, and weighs 0.8% of the total fully loaded vessel weight. This means that about 1/3 of the power provided by installation of one additional 120 kW fuel cell rack is needed just to transport the weight of the fuel cell rack itself.

Weight balance will also need to be closely accounted for. The longitudinal center of gravity is far enough aft that it reduces planing performance and increases vessel drag. The solution to this is to either find a way to move the system weights forward, or design a planing surface that is less "prismatic" and tends to have a larger planing surface further aft to make up for the weight location, or to provide auxiliary lifting devices such as stern wedges or interceptors (See the Design Study Report [10] for more discussion on lifting devices).

The hullform modeled in this analysis is a standard high speed catamaran hull that has not been optimized to the particular weight balance and speed of this vessel because of the preliminary nature of this study. Much work is typically done on the hull shape throughout the design process to optimize for hydrodynamic performance and weight. Optimization could reduce weight and improve resistance characteristics. Computational Fluid Dynamics (CFD) is a valuable software tool that would be used for optimizing the hull parameters to the unique weight magnitude and balance of this particular vessel, but as this vessel is somewhat different than existing designs that EBDG has information on, it is not possible to say with a reasonable level of certainty how much improvement could be realized. Also, while aluminum is the selected hull material, lightweight composites could be examined for further weight savings (up to 40% of the structure weight).

Finally, wake characteristics need to be examined in the next phase of the design to assess their effects on shore erosion. In general, the faster and heavier a boat is, the more power it takes to propel it through the water, and the more energy is imparted into the water. This can generate greater wake sizes (depending on the shape of the hull). Many similarly sized vessels traveling at similar speeds are in service in San Francisco Bay, but this vessel is relatively heavier, so the effect on wake would need to be analyzed using a combination of CFD and empirical wave-breaking formula using methods found in references such as the US Navy Shore Protection Manual.

5 REFERENCES

- [1] Elliott Bay Design Group, "Parametric Weight Estimate," 15051-001-833-1, Rev -, Seattle, WA, February 12, 2016.
- [2] D. Savitsky, "Hydrodynamic Design of Planing Hulls," *Marine Technology*, pp. 71-95, October, 1964.
- [3] D. L. B. a. D. L. Fox, "Small-Craft Power Prediction," *Marine Technology*, vol. 13, no. 1, pp. 14-45, January 1976.
- [4] R. J. B. Donald L. Bount, "Design of Propulsion Systems for High-Speed Craft," in *The Society of Naval Architects and Marine Engineers*, February 29, 1996.
- [5] P. F. T.J. Sherman, "A Study of Planing Catamaran Hull and Tunnel Interactions," in *DRDA Project Report, University of Michigan*, 1975.
- [6] D. Taylor, "The Speed and Power of Ships," U.S. Maritime Commission, 1943.
- [7] TEMA, "LPMR Permanent Magnet Motor & Generator Family - Technical Data," LPMR_tema.hr.pdf.
- [8] D. D. Sten Tamberg, "Email Subject: RE: EBDG visit," September 10, 2015.
- [9] Elliott Bay Design Group, "General Arrangement," 15051-001-101-1, Rev -, Seattle, WA, February 12, 2016.
- [10] Elliott Bay Design Group, "Design Study Report," 15051-001-070-2, Rev -, Seattle, WA, February 12, 2016.

6 CALCULATIONS

Resistance

18 Jan 2016 04:36 PM
HydroComp NavCad 2015

Project ID
Description
File name **cat_resistance_estimate(109'withH2_savitsky).hcnc**

Analysis parameters

Vessel drag		Planing		Added drag	
Technique:	[Calc] Prediction	Appendage:	[Calc] Percentage	Wind:	[Calc] Taylor
Prediction:	Savitsky	Seas:	[Calc] Hoggard	Shallow/channel:	[Off]
Reference ship:		Towed:	[Off]	Margin:	[Off]
Model LWL:		Water properties			
Expansion:	Custom	Water type:	Salt	Density:	1.9908 slug/ft3
Friction line:	ITTC-57	Viscosity:	1.27980e-5 ft2/s		
Speed hump corr:	[On] Apply half (std)				
Propulsor lift corr:	[Off]				
Spray drag corr:	[Off]				
Corr allowance:	0.000250				
Catamaran					
Interference:	[On]				

Prediction method check [Savitsky]

Parameters	FNB [design]	XCG/BPX	Deadrise
Value	3.85	5.61*	16.0
Range	0.66-13.00	0.60-3.00	0.0-30.0

Prediction results

SPEED [kt]	SPEED COEFS			PLANING COEFS				
	FV	FNB	RN	CF	TRIM [deg]	LK/LP	HUMP	LIFTC
26.00	2.125	2.863	3.81e+8	0.001732	2.24	1.341 !	1.757	1.452
27.00	2.207	2.974	3.92e+8	0.001725	2.27	1.330 !	1.653	1.347
28.00	2.289	3.084	4.04e+8	0.001719	2.30	1.319 !	1.563	1.252
29.00	2.371	3.194	4.14e+8	0.001713	2.33	1.307 !	1.484	1.167
30.00	2.452	3.304	4.25e+8	0.001707	2.37	1.295 !	1.415	1.091
31.00	2.534	3.414	4.35e+8	0.001702	2.40	1.283 !	1.356	1.022
32.00	2.616	3.524	4.45e+8	0.001697	2.44	1.271 !	1.304	0.959
33.00	2.698	3.634	4.54e+8	0.001692	2.48	1.258 !	1.260	0.902
34.00	2.779	3.744	4.64e+8	0.001688	2.52	1.245 !	1.221	0.849
+ 35.00 +	2.861	3.855	4.72e+8	0.001684	2.56	1.231 !	1.188	0.801
RESISTANCE								
SPEED [kt]	RBARE [kN]	RAPP [kN]	RWIND [kN]	RSEAS [kN]	RCHAN [kN]	RTOWED [kN]	RMARGIN [kN]	RTOTAL [kN]
26.00	149	0	10	0	0	0	0	159
27.00	144	0	10	0	0	0	0	155
28.00	140	0	11	0	0	0	0	151
29.00	137	0	11	0	0	0	0	148
30.00	134	0	12	0	0	0	0	146
31.00	132	0	13	0	0	0	0	145
32.00	131	0	13	0	0	0	0	144
33.00	130	0	14	0	0	0	0	143
34.00	129	0	14	0	0	0	0	143
+ 35.00 +	129	0	15	0	0	0	0	144
EFFECTIVE POWER		OTHER						
SPEED [kt]	PEBARE [kW]	PETOTAL [kW]	LIFT [kN]	CGRISE [ft]	RBARE/W			
26.00	1990	2122	660	13.95	0.11225			
27.00	2002	2146	660	13.95	0.10873			
28.00	2019	2176	660	13.95	0.10576			
29.00	2042	2213	660	13.94	0.10329			
30.00	2072	2257	660	13.94	0.10130			
31.00	2109	2309	660	13.94	0.09976			
32.00	2152	2368	660	13.94	0.09863			
33.00	2202	2435	660	13.94	0.09787			
34.00	2259	2510	660	13.94	0.09746			
+ 35.00 +	2323	2592	660	13.94	0.09736			

Report ID20160118-1636

HydroComp NavCad 2015 15.01.0039.51091.118

Resistance

18 Jan 2016 04:36 PM
HydroComp NavCad 2015

Project ID
Description
File name **cat_resistance_estimate(109'withH2_savitsky).hcnc**

Hull data

General		Planing	
Configuration:	Catamaran	Proj chine length:	89.40 ft
Chine type:	Single/hard	Proj bottom area:	650.000 ft2
Length on WL:	101.50 ft	LCG fwd TR:	[XCG/LP 0.458] 40.92 ft
Max beam on WL:	[LWL/BWL 11.941] 8.50 ft	VCG below WL:	-13.00 ft
Max molded draft:	[BWL/T 1.789] 4.75 ft	Aft station (fwd TR):	0.00 ft
Displacement:	[CB 0.568] 66.51 LT	Deadrise:	16.00 deg
Wetted surface:	[CS 2.700] 1312.000 ft2	Chine beam:	7.30 ft
Demi-hull spacing:	[S/LWL 0.241] 24.50 ft	Chine ht below WL:	3.00 ft
ITTC-78 (CT)		Fwd station (fwd TR):	50.00 ft
LCB fwd TR:	[XCB/LWL 0.511] 51.86 ft	Deadrise:	16.00 deg
LCF fwd TR:	[XCF/LWL 0.493] 50.00 ft	Chine beam:	7.30 ft
Max section area:	[CX 0.642] 25.920 ft2	Chine ht below WL:	3.00 ft
Waterplane area:	[CWP 1.037] 894.900 ft2	Propulsor type:	Waterjet
Bulb section area:	0.000 ft2	Max prop diameter:	0.0000 ft
Bulb ctr below WL:	0.00 ft	Shaft angle to WL:	0.00 deg
Bulb nose fwd TR:	0.00 ft	Position fwd TR:	0.00 ft
Imm transom area:	[ATR/AX 0.833] 21.600 ft2	Position below WL:	3.00 ft
Transom beam WL:	[BTR/BWL 0.984] 8.36 ft	Transom lift device:	Wedge
Transom immersion:	[TTR/T 0.604] 2.87 ft	Device count:	0
Half entrance angle:	6.00 deg	Span:	4.00 ft
Bow shape factor:	[AVG flow] 0.0	Chord length:	1.00 ft
Stern shape factor:	[AVG flow] 0.0	Deflection angle:	8.00 deg
		Tow point fwd TR:	0.00 ft
		Tow point below WL:	0.00 ft

Report ID20160118-1536

HydroComp NavCad 2015 15.01.0039.S1091.118

Resistance

18 Jan 2016 04:36 PM
HydroComp NavCad 2015

Project ID
Description
File name **cat_resistance_estimate(109'withH2_savitsky).hcnc**

Appendage data

General		Skeg/Keel	
Definition:	Percentage	Count:	0
Percent of hull drag:	0.00 %	Type:	Skeg
Planing influence		Mean length:	0.00 ft
LCE fwd TR:	5.00 ft	Mean width:	0.00 ft
VCE below WL:	-5.00 ft	Height aft:	0.00 ft
Shafting		Height mid:	0.00 ft
Count:	2	Height fwd:	0.00 ft
Max prop diameter:	0.0000 ft	Projected area:	0.000 ft2
Shaft angle to WL:	0.00 deg	Wetted surface:	0.000 ft2
Exposed shaft length:	12.00 ft	Stabilizer	
Shaft diameter:	0.40 ft	Count:	0
Wetted surface:	15.080 ft2	Root chord:	0.00 ft
Strut bossing length:	0.00 ft	Tip chord:	0.00 ft
Bossing diameter:	0.00 ft	Span:	0.00 ft
Wetted surface:	0.000 ft2	T/C ratio:	0.000
Hull bossing length:	0.00 ft	LE sweep:	0.00 deg
Bossing diameter:	0.00 ft	Wetted surface:	0.000 ft2
Wetted surface:	0.000 ft2	Projected area:	0.000 ft2
Strut (per shaft line)		Dynamic multiplier:	1.00
Count:	0	Bilge keel	
Root chord:	0.00 ft	Count:	0
Tip chord:	0.00 ft	Mean length:	0.00 ft
Span:	0.00 ft	Mean base width:	0.00 ft
T/C ratio:	0.000	Mean projection:	0.00 ft
Projected area:	0.000 ft2	Wetted surface:	0.000 ft2
Wetted surface:	0.000 ft2	Tunnel thruster	
Exposed palm depth:	0.00 ft	Count:	0
Exposed palm width:	0.00 ft	Diameter:	0.00 ft
Rudder		Sonar dome	
Count:	1	Count:	0
Rudder location:	Free stream	Wetted surface:	0.000 ft2
Type:	Balanced foil	Miscellaneous	
Root chord:	2.00 ft	Count:	0
Tip chord:	2.00 ft	Drag area:	0.000 ft2
Span:	3.00 ft	Drag coef:	0.00
T/C ratio:	0.150		
LE sweep:	0.00 deg		
Projected area:	6.000 ft2		
Wetted surface:	12.179 ft2		

Environment data

Wind		Seas	
Wind speed:	13.50 kt	Significant wave ht:	2.90 ft
Angle off bow:	0.00 deg	Modal wave period:	7.5 sec
Gradient correction:	Off	Shallow/channel	
Exposed hull		Water depth:	0.00 ft
Transverse area:	99.000 ft2	Type:	Shallow water
VCE above WL:	2.00 ft	Channel width:	0.00 ft
Profile area:	923.265 ft2	Channel side slope:	0.00 deg
Superstructure		Hull girth:	0.00 ft
Superstructure shape:	Cruise ship		
Transverse area:	462.000 ft2		
VCE above WL:	12.00 ft		
Profile area:	923.265 ft2		

Report ID20160118-1536

HydroComp NavCad 2015 15.01.0039.S1091.118

Resistance18 Jan 2016 04:36 PM
HydroComp NavCad 2015Project ID
Description
File name cat_resistance_estimate(109'withH2_savitsky).hcnc**Symbols and values**

SPEED = Vessel speed
FV = Froude number [VOL]
FNB = Froude number [BPX] by effective chine beam
RN = Reynolds number [LM] by mean planing length
CF = Frictional resistance coefficient
TRIM = Dynamic trim angle
LK/LP = Predicted wetted keel vs chine length ratio
HUMP = Blount (M factor) hump-speed multiplier
LIFTC = Hydrodynamic planing lift coefficient

RBARE = Bare-hull resistance
RAPP = Additional appendage resistance
RWIND = Additional wind resistance
RSEAS = Additional sea-state resistance
RCHAN = Additional shallow/channel resistance
RTOWED = Additional towed object resistance
RMARGIN = Resistance margin
RTOTAL = Total vessel resistance

PEBARE = Bare-hull effective power
PETOTAL = Total effective power

LIFT = Hydrodynamic planing lift force
CGRISE = Rise in VCG from static
RBARE/W = Bare-hull resistance to weight ratio

+ = Design speed indicator
* = Exceeds parameter limit

Resistance

18 Jan 2016 04:37 PM
HydroComp NavCad 2015

Project ID
Description
File name **cat_resistance_estimate(109'withH2_savitsky).hcnc**

Analysis parameters

Vessel drag		Planing		Added drag	
Technique:	[Calc]	Prediction		Appendage:	[Calc] Percentage
Prediction:		Savitsky		Wind:	[Calc] Taylor
Reference ship:				Seas:	[Calc] Hoggard
Model LWL:				Shallow/channel:	[Off]
Expansion:		Custom		Towed:	[Off]
Friction line:		ITTC-57		Margin:	[Off]
Speed hump corr:	[On]	Apply half (std)		Water properties	
Propulsor lift corr:	[Off]			Water type:	Salt
Spray drag corr:	[Off]			Density:	1.9908 slug/ft3
Corr allowance:		0.000250		Viscosity:	1.27980e-5 ft2/s
Catamaran					
Interference:	[On]				

Predicted resistance

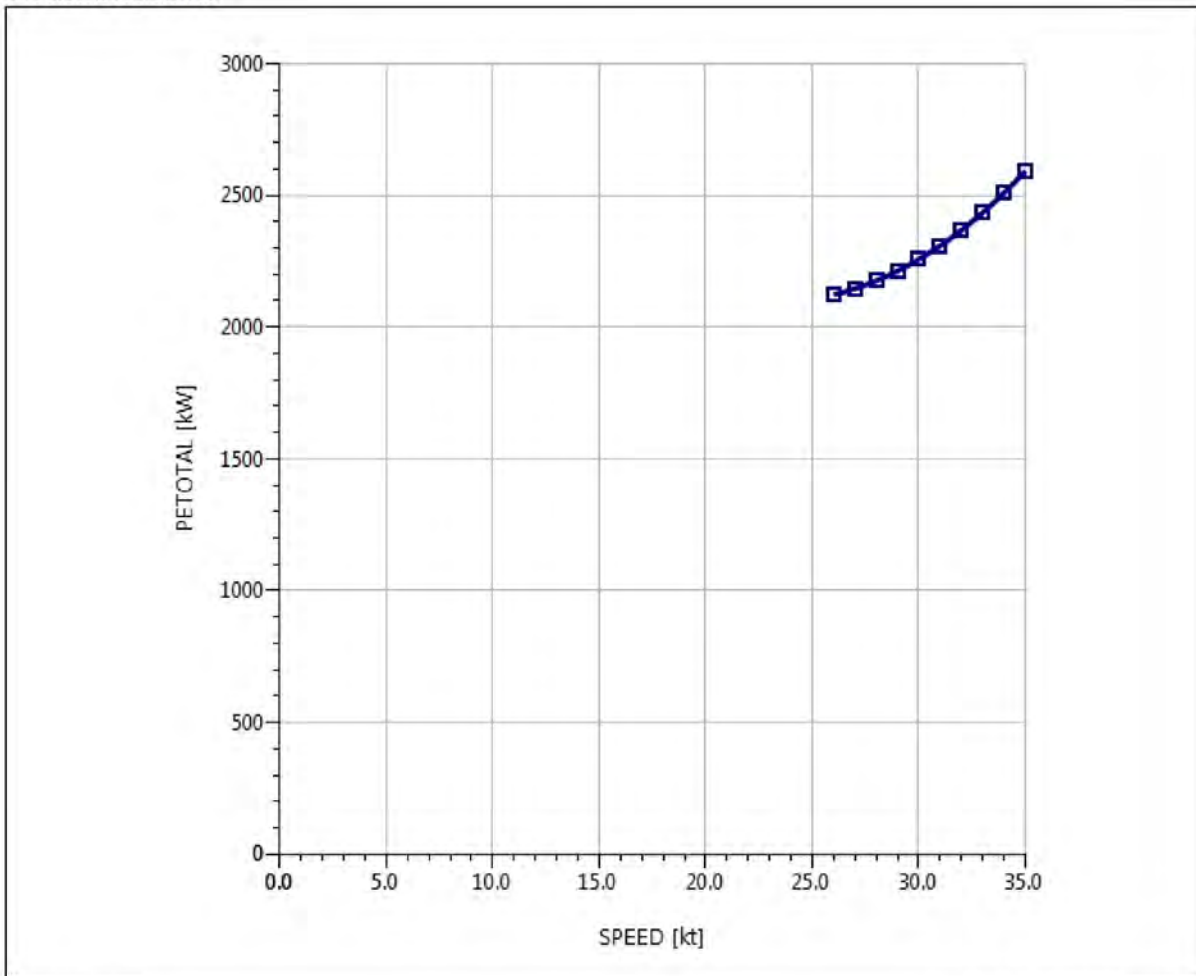

Report ID20160118-1637

HydroComp NavCad 2015 15.01.0039.S1091.118

MEMORANDUM

Vessel: SF-BREEZE Ferry Feasibility Study
Engineer: Kelly Sonerholm, PE
Reference: J15051-04M
Date: February 12, 2016



Subject: Preliminary Tonnage Calculation

This memo describes the tonnage calculations performed on the SF-BREEZE Ferry Feasibility Study. The vessel is a high-speed planing catamaran with dimensions of 109 ft x 33 ft x 8.25 ft. The intended route is on San Francisco Bay servicing daily commuters to and from the downtown area.

At 109' length overall, the number of below deck subdivisions is set at 10. Stations are shown in the figure below.

Stations 1-5 are possible to exempt with the installation of tonnage bulkheads. Stations 6-10 are included in the calculation. Station 11 is framed to have no area. All sectional measurements have been estimated pending lines development.

On the main deck, all internal compartments are exempt: The fuel cell space and switchboard rooms are exempt due to being machinery spaces. The passenger space is exempt because of the placement of qualified tonnage openings port and starboard in the forward bulkhead, in way of the doors.

On the second deck, the only non-exempt space is the liquid hydrogen tank. It is included in the calculation.

In conclusion, the gross register tonnage of the vessel is 87.24, which allows the vessel to be inspected under Subchapter T of 46 CFR (46 CFR 175.1109(a)).

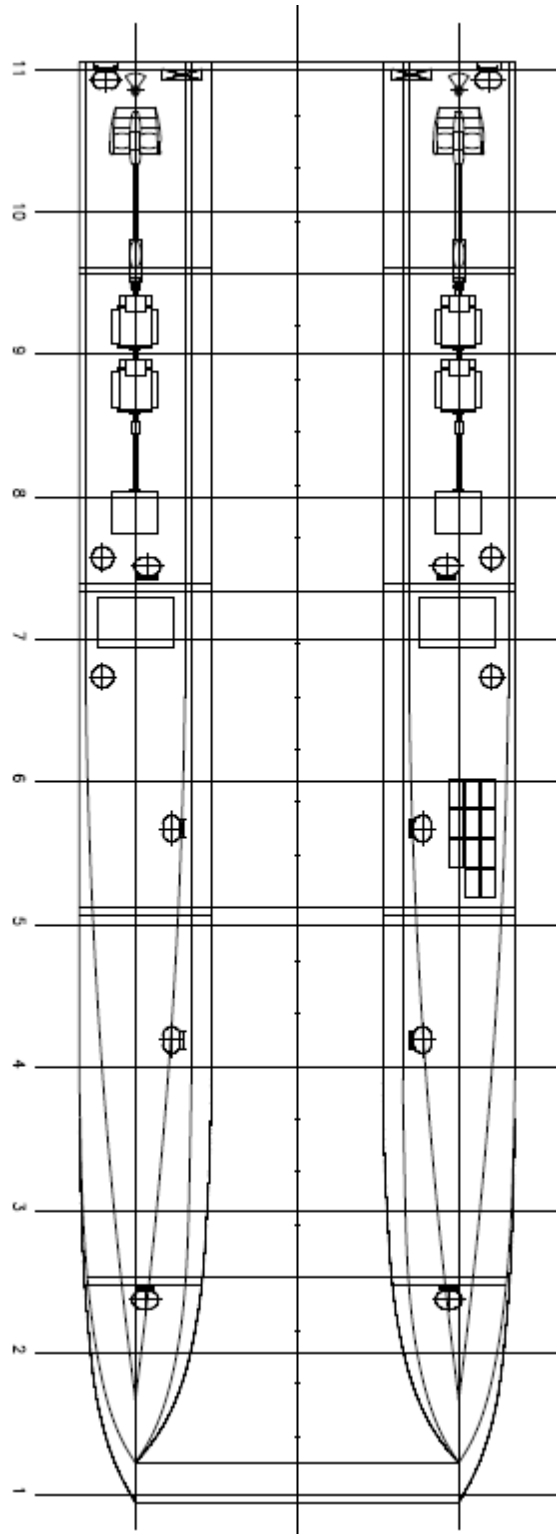
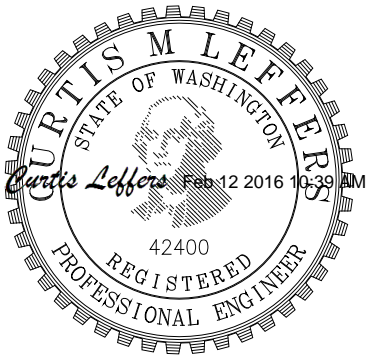

Figure 1 – Tonnage Stations



SF-BREEZE FERRY FEASIBILITY STUDY

Bunkering Procedure

Prepared for: Sandia National Laboratories • Livermore, CA

Ref: 15051-001-062-1

Rev. -

February 12, 2016

PREPARED BY

Elliott Bay Design Group
5305 Shilshole Ave. NW, Ste. 100
Seattle, WA 98107

GENERAL NOTES

This document is intended to describe ship board side of bunkering operations for the SF-BREEZE ferry. It is preliminary in nature and further development will be necessary if the project moves forward. A full description of the shoreside facilities and operations is produced by Sandia National Laboratories.

REVISIONS

REV	DESCRIPTION	DATE	APPROVED
P0	Preliminary Issue	1/14/16	CML 42400
P1	Preliminary Issue	1/21/16	CML 42400
-	Initial Issue	2/12/16	CML 42400

TABLE OF CONTENTS

	PAGE
1 Purpose	1
2 Description	1
2.1 Shoreside Facilities	1
2.2 Shipboard Systems	1
2.2.1 Hydrogen Fuel Cells	1
2.2.2 Fuel Tank	1
2.2.3 Bunkering Station	2
2.2.4 Boil off	2
2.3 Personnel	2
2.4 Selection of Inert Gas	2
2.4.1 Helium	2
2.4.2 Nitrogen	3
3 Bunkering Procedure	4
4 Applicable guidelines and regulations	6
Appendix A	7
ABS Recommended Safeguards	

1 PURPOSE

The purpose of this report is to provide a concept bunkering procedure for the SF-BREEZE (San Francisco Bay Renewable Energy Electric vessel with Zero Emissions) High Speed Hydrogen Ferry, and to discuss other infrastructure and procedures which may be needed. The vessel is a high-speed catamaran with dimensions of 109 ft x 33 ft x 11.25 ft. The total height of the vessel (air draft) above the waterline is approximately 38.25 ft.

The liquefied hydrogen (LH₂) tank is considered to be permanently installed on the SF-BREEZE. This necessitates refueling of the on-board LH₂ tank with LH₂ from a shoreside tank.

2 DESCRIPTION

2.1 Shoreside Facilities

The shoreside refueling facility needs to be able to provide fuel to the vessel twice per day, at about 1,000 kg (3,800 gallons) for each refueling. The daily schedule for the ferry is two round trip voyages for morning commuter traffic, and two for afternoon commuters. Therefore, the entire refueling process will need to be completed during a 1 hour mid-day break period, and once again either at the end of the day or before operations begin in the morning.

The fill/return hoses would be connected using a loading arm, which would swing the hose into the vicinity of the bunkering station on the upper deck. During fueling, the facility will need to be able to accept a venting/inerting return hose from the vessel so that exhaust hydrogen and other gasses can be vented at a safe distance away from the vessel and any ignition sources.

2.2 Shipboard Systems

2.2.1 Hydrogen Fuel Cells

The hydrogen fuel cells will be running to provide power to shipboard loads during bunkering. It may be possible to provide the needed power with a single 120 kW rack of fuel cells, and the remaining racks may be taken off line. The vessel is designed such that the hydrogen vented during bunkering would not be exposed to ignition sources caused by keeping systems online; therefore, it is safe to continue to run fuel cells during bunkering.

2.2.2 Fuel Tank

The ship's fuel tank carries 1200 kg of LH₂ (about 4,500 gallons), which is enough for two round trip voyages of 25 nautical miles at 35 knots each way, and allowing for about 200 kg remaining in the tank for margin and to keep the tanks cold prior to refueling. The bunkering pipe sizes and pump size will be designed based on the 1 hour time available for the complete refueling process, which allows about 30 minutes for the actual fuel transfer.

The fuel tank will be fitted with fill lines on the bottom and the top of the tank. The top fill line is fitted with a spray rail to cool the tank quickly and drop its pressure as it is being filled.

The ship's fuel tank also has a pressure build loop which is used to increase pressure by applying heat to the fluid so that higher pressure hydrogen gas can be supplied to the vaporizers, and ultimately the fuel cells. These components likely will not come into use during bunkering.

2.2.3 Bunkering Station

The bunkering station consists of two hose connections, one for hydrogen/inert gas fill, and one for cooldown gas return. These will be connected via hose to the shoreside facility. Each hose can be fitted with a quick acting dry break coupling and an emergency release coupling. Regulation may not require the use of a return line. Venting directly from the vessel rather than using a return line to shore may be considered safe, and may reduce the required bunkering time.

2.2.4 Boil off

A small amount of boil off will also occur on the vessel if the tank is over pressurized or if the contents of the tank are warmed by the environment and not consumed by the fuel cells. The excess pressure is relieved out of a vent stack located aft and above the fuel tank. See the General Arrangement [1]. This would occur prior to fuel transfer in order to reduce pressure of the vessel's tank.

2.3 Personnel

Three to four persons may be involved in the bunkering operation. One crew member should be at the vessel bunkering station on the upper deck to hook up the hose(s) and operate valves on the vessel. A second crew member should be available as a "fire watch" in order to make sure that there are no fires, fire risks, or significant spilling/venting during the entire process. One of these people should be the vessel's captain (the Person In Charge, or PIC). Shoreside, one person will be needed to operate the crane which loads the hoses onto the vessel. This person may be the same person who operates the shoreside valves that precool the lines before the vessel arrives, and transfer fuel onto the vessel. For safety reasons and time constraints, it may be necessary to have a second shore side person available.

References [2], [3], [4], and [5] give recommendations on crew training for LNG and cryogenic fluid bunkering procedures. Guidance should also be followed on periodic testing and maintenance of the equipment by personnel involved in bunkering.

2.4 Selection of Inert Gas

2.4.1 Helium

Helium has the advantage of being the only gas that will not freeze at LH₂ temperatures, making it convenient for purging lines before and after the LH₂ transfer. However, it bears mentioning that the helium, unlike nitrogen which is used to inert LNG bunkering lines, is not renewable. Helium that is vented to the atmosphere is not recoverable since it is so light (like hydrogen) and ultimately escapes the earth's atmosphere. Also, unlike nitrogen or hydrogen, helium is not abundant on earth. All helium that is available on earth is mined from underground sources that only exist because of billions of years of subterranean radioactive decay where the helium becomes contained. Since this feasibility study investigates the potential for large-scale public operations, the potential exists for consumption of a large amount of helium over time. And since environmental impacts are driving this study, if helium is used it is suggested that considerations be made as to ways of recovering the helium, perhaps by collection of the gasses being vented during purging. The gasses would be a mixture of helium, hydrogen, and other trace atmospheric gasses. If recovered, this gas could be processed to re-purify the helium for reuse.

2.4.2 Nitrogen

Nitrogen is more abundant and is inexpensive. However, it will freeze into solid masses at LH_2 temperatures. It may still be used for inerting instead of helium if a two-step process is followed. During initial purge and cooldown, the bunkering line is purged with nitrogen to remove all the air. Then the line is purged with gaseous hydrogen at ambient temperature to remove the nitrogen. LH_2 can then be introduced into the line. The process for disconnecting the line at the end of bunkering would be in reverse. Although a slightly more complicated procedure, this has the advantage of being a less expensive and a sustainable process suitable for future large scale deployments.

3 BUNKERING PROCEDURE

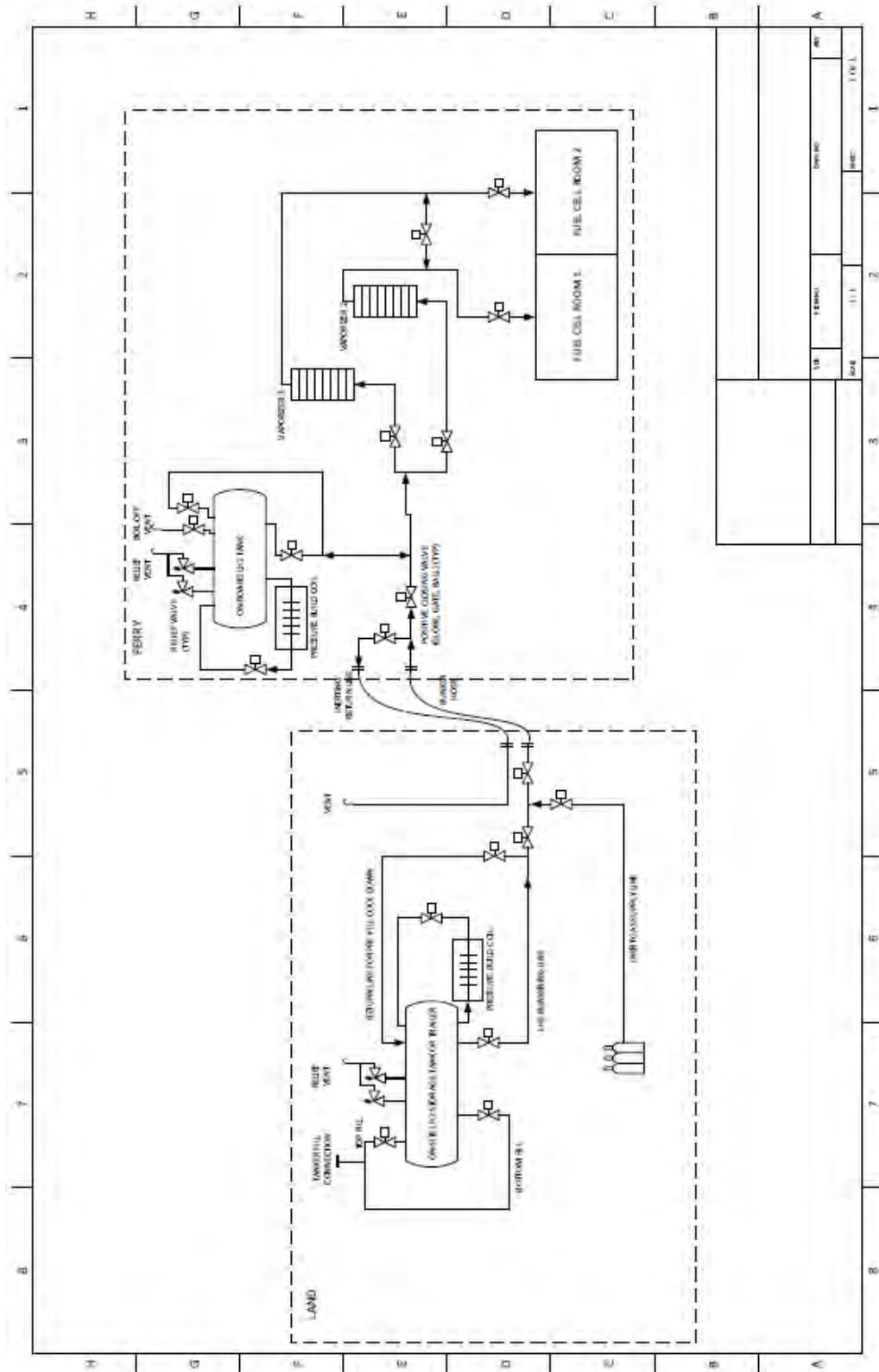

Figure 1: A conceptual bunkering Flow Diagram for the case of a land-based storage tank

1. Per guideline [5], notification may need to be provided to the local Captain of the Port (COTP) prior to bunkering.
2. Equipment Check – Prior to any bunkering operations beginning, all of the equipment at the shoreside facility should have its condition checked. This should include, in particular, the hardware, detectors, and automatic shutoffs that mitigate damaging effects in the event of an equipment failure.
3. Precooling – Prior to the arrival of the ferry for refueling, the shoreside fill, vent, and recirculation lines will be cooled by LH₂ in the storage tank. Precooling the lines will allow bunkering to proceed more quickly since there will be less boil off at the time of the transfer. (approx. 45 minutes)
4. Precooling of Shoreside Cargo Pump (if installed) - Precooling is required before the pump can operate at cryogenic temperatures. Installation of a pump may not be necessary for transfer if the storage tank is kept at a high enough pressure. (approx. 15 minutes if pump is installed and used)
5. Arrival of Vessel – Note that the processes preceding the arrival of the vessel may take up to an hour. Plan to have crew begin the precooling process with sufficient time beforehand.
6. Connection of the Bunkering Hose – Connect both the bunkering hose, and the inerting return line, which is used after bunkering for inerting and venting. Inspect the dry break connections to ensure that they are in working condition. Because the bunkering station is on the top deck of the ferry, it will probably be necessary to use a loading arm, crane, or platform to position the hoses. Venting is primarily to be done on land. If venting on-board is allowed and desired, the inerting return line is not necessary. (approx. 5 minutes)
7. Inerting of line and hose – Inerting removes air (nitrogen, oxygen, etc.) and moisture before the bunkering process commences to ensure a pure fuel supply in the ship's tank for the fuel cells. (target <5 minutes)
8. Precooling and Purging – Once the fill line and hose have been 100% inerted, these lines are purged with hydrogen from the shoreside storage tank. This removes the inert gas so that the supply to the ship's fuel tank is nearly pure hydrogen, and cools the line to liquid hydrogen temperature. If helium is used as the inert gas, this can be done in a single step, if nitrogen is used, this will be a two-step process as described in 2.4.2. (target <15 minutes, depends on length of the fill line)
9. Filling – Fill the vessel fuel tank from the shoreside storage tank. With the use of a pressure build loop on the shoreside hydrogen tank, the pressure in the lines may be increased enough to perform the transfer without the use of a pump. If not, then use the pump to complete the transfer. (target <30 minutes for the actual fill process)
10. Liquid Line Stripping – Residual hydrogen warms and expands, and is forced into both the ship tank and the shoreside tank. Open and close the ship side valve to allow remaining expansion to go into shipboard tanks. (target 15 minutes)

Performing this action allows liquid hydrogen remaining in the lines to be recovered. Hydrogen vapor takes up about 800 times the volume of liquid hydrogen, so this would allow most of it to be recovered as the expanding vapor forces the remaining fuel back

into the storage tank. However, considering time constraints on the bunkering process, it may make more sense to skip this step and vent the hydrogen in the lines rather than spending the time needed to warm the remaining hydrogen to the point where it could be recovered.

11. Liquid Line Inerting – Vent and purge the remaining hydrogen from the fill line with inert gas from storage. Inert gas and hydrogen will be vented to the atmosphere (or possibly recovered). This may be a two-step process if nitrogen is used. (target 5 minutes)
12. Disconnection – Manually disconnect the hose(s) and crane them back to storage shoreside. (5 minutes)
13. Loading of Passengers – Loading may not be allowed to commence until bunkering has been finished. Section 6.3 of the ABS Bunkering Report gives guidance on Simultaneous Operations and how to evaluate the potential risks.
14. Departure

Total anticipated turnaround time (excluding passenger embarkation) <65 minutes.

4 APPLICABLE GUIDELINES AND REGULATIONS

- [1] Elliott Bay Design Group, "General Arrangement," 15051-001-101-1, Seattle, WA, February 12, 2016.
- [2] American Bureau of Shipping, "LNG Bunkering: Technical and Operational Advisory".
- [3] American Bureau of Shipping, "Bunkering of Liquefied Natural Gas-fueled Marine Vessels in North America".
- [4] US Coast Guard office of Commandant, "Guidance Related to Vessels and Waterfront Facilities Conducting Liquefied Natural Gas (LNG) Marine Fuel Transfer (Bunkering) Operations," Washington, D.C., February 19, 2015.
- [5] US Coast Guard office of the Commandant, "Guidelines for Liquefied Natural Gas Fuel Transfer Operations and Training of Personnel on Vessels Using Natural Gas as Fuel," Washington, D.C., February 19, 2015.
- [6] US Code of Federal Regulations, "46 CFR 154 - Safety Standards for Self-Propelled Vessels Carrying Bulk Liquefied Gases".

Appendix A

ABS Recommended Safeguards

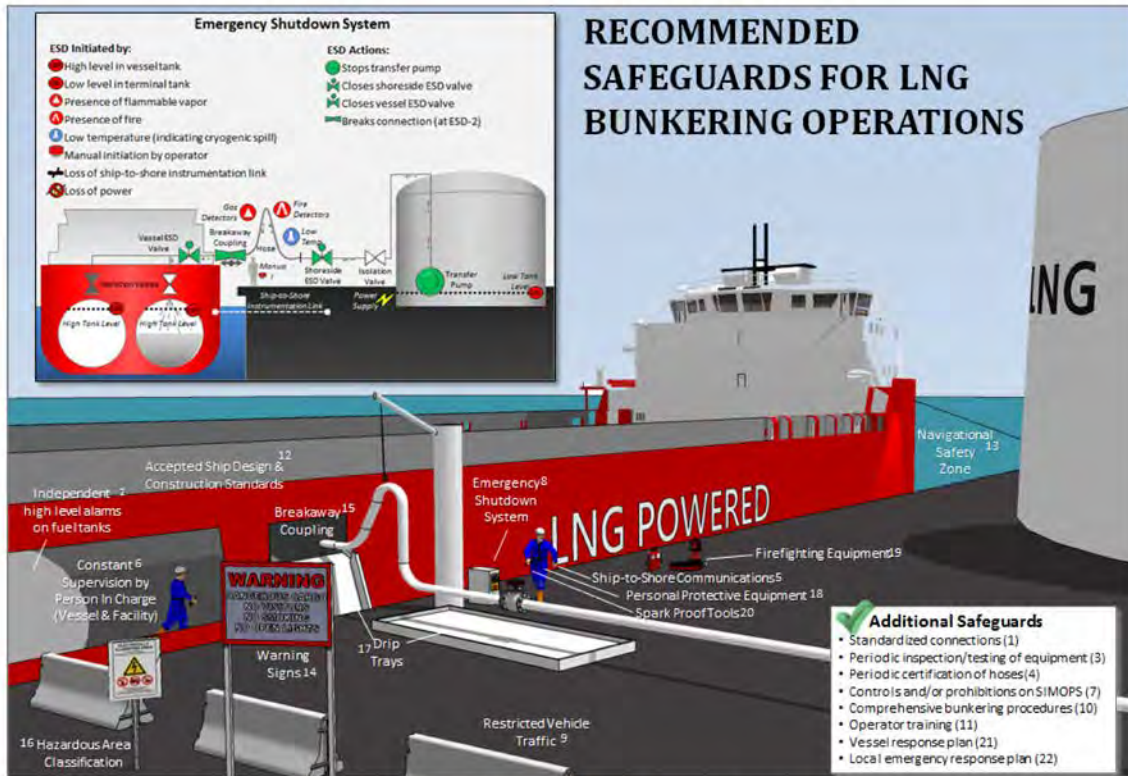

Table 2 Prevention Safeguards

Prevention Safeguards	
1	Standardized connections at bunkering station to prevent inadvertent leaks or hose disconnects.
2	Independent high level alarms on vessel fuel tanks to alert operators prior to tank overfill. Note: Separate high level switch initiates emergency shutdown (ESD) (See safeguard # 8).
3	Periodic inspection and testing of equipment prior to bunkering to ensure system is functional and there are no leaks.
4	Periodic testing and certification of hoses to ensure hoses and fittings will not leak or disconnect during transfer.
5	Ship-to-shore communications to ensure information can be shared between parties involved in bunkering (e.g., person in charge [PIC], ship crew, truck driver).
6	Constant supervision by PICs on both vessel and facility.

Table 3 Safeguards that Prevent and Mitigate

Prevention Characteristics	Mitigation Characteristics
7. Controls and/or prohibitions on simultaneous operations (SIMOPS)	
Reduces likelihood of dropping cargo or stores on LNG transfer equipment or external impact from vehicles or equipment involved in simultaneous operations.	Reduces crew/passenger population in hazardous areas and reduces potential ignition sources from simultaneous operations.
8. ESD system	
Reduces likelihood of overfilling vessel fuel tanks through automatic shutdown on high level.	Reduces the amount of LNG release by closing valves and stopping transfer pumps during hazardous conditions.
9. Restricted vehicle traffic	
Reduces likelihood of vehicle impact with bunkering equipment	Reduces population in hazardous area near vessel and limits possible ignition sources in the case of an LNG release.
10. Comprehensive bunkering procedures	
Addresses a broad array of prevention topics including: operating conditions, required equipment, safety, training, communications, mooring, connection, transfer, lifting, and disconnection.	Addresses a broad array of mitigation topics, including: safety, simultaneous operations, and emergency operations.
11. Operator training	
Covers a broad array of prevention topics to ensure that operators are trained in safe work practices and understand all tasks for normal and nonroutine operations.	Covers a broad array of mitigation topics to ensure that operators are aware of LNG hazards and are trained for emergency operations.
12. Accepted ship design and construction standards	
Safe ship arrangements, manufacture, workmanship, and testing to minimize probability of LNG leaks.	Ship design standards to mitigate impacts on people and property in case of an LNG release (e.g., fire safety equipment, electrical classification, ventilation).
13. Regulated Navigation Areas	
Reduces likelihood of vessel impact with bunkering equipment.	Reduces population in hazardous area near vessel and limits possible ignition sources in the case of an LNG release.
14. Warning signs	
Reduces likelihood of external impact with bunkering equipment.	Reduces population in hazardous area near vessel and limits ignition sources near bunkering operations to reduce likelihood of a fire if a release of LNG occurs.

Table 4 Mitigation Safeguards

Mitigation Safeguards	
15	Breakaway couplings on hose connections designed to minimize LNG releases in the case of excessive movement (e.g., truck drive-away, vessel drifting away).
16	Hazardous area classification near bunkering operations where accidental releases could occur to limit ignition sources.
17	Drip trays (aluminum or stainless steel) to collect and isolate LNG spills protecting ship areas from cryogenic hazards.
18	Personal protective equipment to protect operators from exposure to cryogenic and fire hazards.
19	Firefighting equipment , including dry chemical and water deluge systems, to mitigate fire damage if LNG release ignites.
20	Spark-proof tools to reduce likelihood of ignition if LNG is released.
21	Vessel emergency response plans with procedures to guide crew in addressing various LNG-related hazards.
22	Local emergency response plans with procedures to guide first responders in addressing various LNG-related hazards.

Vessel Compatibility

One of the key steps in safe LNG bunkering is verifying that the supplying vessel or facility and the receiving vessel are compatible. Compatibility covers a wide range of topics and because of the complexity of LNG bunkering, it is more important to confirm compatibility than for oil fuel bunkering. A vessel compatibility assessment should be carried out prior to LNG bunkering operations. Compatibility is normally agreed and confirmed in writing prior to the start of bunkering as part of the bunkering procedures. An easy way to do this is to fill out a checklist to confirm compatibility before each bunkering operation.

A compatibility review should address all shore-to-ship or ship-to-ship considerations, including:

1. Confirmation that the receiving vessel (and supply vessel, if applicable) can be safely moored and that adequate fendering or spacing is provided between the vessels or to the facility to prevent damage. Any restrictions on length should be noted. Moorings should be sufficient to keep the vessel(s) restrained for anticipated wind, tide and weather conditions, and any expected surges from passing vessels.
2. The relative freeboard of the vessel(s) or facility should allow hoses to reach from the bunker supply connection to the bunker receiving connection with sufficient slack to allow for any expected relative motion between the two. Any restrictions on freeboard should be noted.
3. The manifold arrangements, spill containment systems, and hose connections for the supply source and the receiving vessel should be confirmed. Capability for emergency release (hose breakaway) with minimal gas release should be provided. The means to prevent electrical arcing at the manifold is to be evaluated and addressed.
4. Confirmation that both the supply source and receiving vessel have compatible emergency shutdown connection, defined emergency procedures and safety systems.
5. Confirmation that the size and scope of the hazardous areas on both the supply source and the receiving vessel are compatible (i.e., that the size of one is not beyond the size of the other). The goal is to keep any sources of ignition from either the supplier or receiving vessel outside of the other's hazardous area.
6. Confirmation that the volume, pressure, and temperature of the supply source are compatible with the tanks on the receiving vessel.
7. If it is determined that the receiving vessel requires vapor return, then confirmation is needed that the supply source can accept returned vapor and that the vapor return systems are compatible.
8. Confirmation that inerting and purging capabilities exist at both the supply source and receiving vessel.
9. Confirmation that communications equipment is compatible and the required connections and interfaces are provided so that both the bunker supplier and receiver can monitor the bunkering operation and both can initiate an emergency shutdown of the complete transfer operation.
10. Confirmation of the provision and compatibility of the electrical isolation arrangements.



SF-BREEZE FEASIBILITY STUDY

Preliminary Risk Assessment

Prepared for: Sandia National Laboratories • Livermore, CA

Ref: 15051-001-168-1

Rev. -

February 12, 2016

PREPARED BY

Elliott Bay Design Group
 5305 Shilshole Ave. NW, Ste. 100
 Seattle, WA 98107

GENERAL NOTES

1. This document is a high-level discussion of risk factors that may affect the subject vessel as a uniquely designed high speed ferry which uses hydrogen as a fuel source.

REVISIONS

REV	DESCRIPTION	DATE	APPROVED
P0-P2	Preliminary Issues – Returned with comments from Sandia and internal review	2015	KTS 48364
P3	Preliminary Issue	1/21/16	KTS 48364
-	Initial Issue	2/12/16	KTS 48364

TABLE OF CONTENTS

	PAGE
1 Purpose	1
2 Procedure	1
3 Risk Assessment	2
3.1 Hydrogen Leak	2
3.1.1 Slow Leak - Exterior (from LH ₂ Tank, Piping, or Vaporizer)	2
3.1.2 Large Leak – Exterior (from LH ₂ Tank, Piping, or Vaporizer)	3
3.1.3 Interior Leak (Fuel Cell Room)	4
3.2 Hydrogen Tank	5
3.2.1 Overfill	5
3.2.2 Underfilled	6
3.2.3 Gunfire	6
3.3 Fuel Cells	6
3.3.1 Failure	6
3.3.2 Ventilation Failure	7
3.4 Batteries	8
3.4.1 Overcharge/Failure	8
3.4.2 Fire on Upper Deck	8
3.5 Other Propulsion Systems	9
3.6 Collision	10
3.7 Fuel Spill During Bunkering	10
4 References	12

1 PURPOSE

The purpose of this report is to discuss risks that may be present in the operation of the subject vessel, a 109 ft x 33 ft x 11.25 ft high-speed catamaran passenger vessel powered by hydrogen fuel cells. Overall height from the waterline to the top of the fuel tank vent is about 38.25 ft. The hydrogen is stored in liquefied (LH₂) form. Because the vessel is of a novel design which uses hydrogen fuel, some of the risks considered in this report are relatively new to the maritime industry. Sandia National Laboratories has performed research and analysis regarding the risks associated with the properties of hydrogen as fuel, and their findings are incorporated into this assessment. It is important to note that this risk assessment has been developed to the commensurate level of detail with a feasibility study. Further identification and development of the project risks will be necessary as part of a developing a detailed design.

2 PROCEDURE

A risk assessment is used as a decision-making tool to determine which risks warrant further examination and mitigating actions. Events of considerable risk may necessitate design features that are beyond the scope of the feasibility study, or recommended practices that differ from those of normal vessel operation. All currently implemented risk-mitigating design features, and those that may require future analysis are discussed in the Risk Assessment section.

References [1] and [2] were used as general guidance in developing the preliminary risk assessment. The first step was to identify some of the major potential risks related to the application of the proposed concept and document them in this report. Once the risks were identified, they were scored to determine overall potential severity.

There are many methods of assessing risk, but with most methods, risk can be simply defined as:

$$\text{Risk Score } (R) = \text{Frequency } (P) \times \text{Consequence } (S)$$

Frequency (or probability) is the likelihood that a certain event will happen, and consequence is a subjective quantification of the damaging results that would occur. The SF-BREEZE represents a new assembly of established individual technical pieces. Thus risk must be assessed for the new assembly as a whole. However, the technical components of the vessel, namely liquid hydrogen storage, Proton Exchange Membrane (PEM) fuel cells and associated hardware all have established track records in other applications, allowing risk to be assessed for the SF-BREEZE. To simplify the comparison of risk, the quantification of frequency and consequence is estimated on a numerical scale, and the results for each event are compared. For purposes of this report, the scale values are defined in Table 1.

Table 1: Risk Scale Matrix

Scale Value	Probability (P)	Consequence (S)
1	Unlikely to ever happen in the life of the vessel	Results in little or no downtime or expense
2	Unlikely to happen more than once in the life of the vessel	Results in less than one week of downtime and/or moderate expense
3	Likely to happen multiple times per year	Results in significant downtime and/or expense
5	Likely to happen multiple times per month	Results in significant downtime, expense, and small chance of injury
10	N/A	Results in significant downtime, expense, and likely injury
20	N/A	May result in loss of the vessel or human life

3 RISK ASSESSMENT

The following are descriptions of risks that are uniquely associated with the concept design as a hydrogen powered high-speed passenger ferry.

3.1 Hydrogen Leak

3.1.1 Slow Leak - Exterior (from LH₂ Tank, Piping, or Vaporizer)

Description

A slow hydrogen vapor leak on the exterior upper deck could result from improper hardware installation, or damage to piping, valves, or the tank itself.

If confined, a small leak may result in a hazardous atmosphere being produced. In the presence of a spark or flame, this incident may lead to fire.

A small fire on the upper deck that could be caused by a slow leak is of some concern because of the possibility of furthering damage. However, the double wall construction of the tank would prevent fire from causing further damage to the tank itself. A small, sustained, "torch" of fire that could be ignited from a slow leak could have the potential to damage nearby components or structures to the point that repairs would need to be made. It would also present a hazard if personnel happened to be nearby, but the exterior upper deck is normally unoccupied by crew and is off-limits to passengers.

Score

P = 3, S = 1, R = 3

Mitigating Actions

In all cases except for direct damage to the tank itself, there will be either an automatic or manual shutoff valve that will stop further release. Automatic shutoff will occur when an abnormal drop in system pressure, presence of hydrogen, or presence of flames is detected. With no confined areas in the vicinity of the tank, piping, and vaporizer on the top deck, the chance of reaching a hazardous atmosphere with a small leak is negligible. The SF-BREEZE design minimizes the presence of ignition sources on the top deck, mitigating the fire risk even if a hazardous atmosphere is reached.

3.1.2 Large Leak – Exterior (from LH₂ Tank, Piping, or Vaporizer)

Description

A large leak could occur because of a major component failure or physical damage to the system. Depending on the severity and location of the leak, the leaking hydrogen may be in liquid or cold vapor form.

The consequence of a leak could be formation of a hazardous atmosphere and/or damage to surrounding components.

A liquid leak which contacts the deck or containment would cause little structural damage because of the favorable properties of aluminum at cryogenic temperatures. Unlike high-strength steels, aluminum does not suffer hydrogen embrittlement, and will not suffer brittle fracture (lose structural strength) when cooled to cryogenic temperatures. Thus, there will be no damage to the aluminum deck if exposed to LH₂. However, in the presence of an ignition source such as a spark or flame, this incident may lead to a large fire.

A fire on the upper deck is of concern because of the possibility of damage to the LH₂ tank and possible release of hydrogen. Such a fire could have its source in the passenger cabin, fuel cell room, or be due to a leak directly from the LH₂ tank itself. If the LH₂ tank is exposed to a fire, the superinsulation of the tank is likely to be sufficient to prevent significant boil-off, but any boil-off would be vented to a safe location as usual. A severe fire could cause a complete structural failure of the tank and subsequent release of the fuel which would then ignite. The danger to passengers or crew on the vessel is probably low due to the buoyancy of the hydrogen. Ignition of all of the contents of the fuel tank would produce a large flame that would rapidly rise hundreds of feet into the air away from persons on board. Containment of this sort of fire is not practical since it would likely last less than 10 seconds [3] in the event of complete failure and spillage. It is possible that if there were high downdraft winds, or a torch that was not directed upwards, that the flames could reach locations on the vessel that had other systems, crew, or passengers. It is much more likely, however, that the hydrogen would quickly dissipate upward and any fire could only be a danger to structures above the ferry, such as a bridge.

Score

P = 1, S = 5, R = 5

Mitigating Actions

Appropriate selection of components considering the service conditions (cryogenic temperatures, hydrogen, marine environment), following the established codes, and using designs and suppliers with proven usage will mitigate against component failure.

Automatic shutoff will be triggered by an abnormal loss of pressure or hydrogen level and by hydrogen and flame detectors in the vicinity.

The only way to prevent the sort of damage needed to cause a large leak would be to further reinforce the tank or other components or enclose the tank or other components in a protective bulkhead. Neither of these options are currently being considered as the probability of this occurrence is considered to be very low given the mitigation practices discussed above and the robust construction of the tank (3/8" thick inner stainless steel liner surrounded by a 1/4" thick carbon steel outer liner), as well as the location of the tank and components on the top deck. The vicinity of the fuel tank is a restricted personnel area, and protected from external impacts since it is far from the waterline and in the lateral center of the vessel. In addition, enclosing this equipment is not desired because it would increase the risk of forming a hazardous environment.

In case of a fire, the tank has built-in superinsulation to prevent excessive heating of the LH₂. If the insulation is compromised, the heating of the LH₂ will increase the pressure in the tank to the point where the boil-off valve opens and the contents are released in a controlled manner out of the vent mast to a safe location.

3.1.3 Interior Leak (Fuel Cell Room)

Description

A leak of hydrogen in and of itself is not necessarily a risk if it is of a very small amount. Hydrogen does not cause any environmental or toxicity concerns. At low concentrations, flammability is not an issue. Safety measures discussed below prevent the hydrogen concentration from ever reaching the lower flammability limit where ignition could occur.

If the shutoff systems failed and hydrogen were somehow released into an enclosed space such as the fuel cell room in an uncontrolled way, the concentration of hydrogen could reach a point where ignition was a near certainty if enough ignition energy was present. This would depend on the speed of the leak and whether or not the ventilation system could prevent the concentration of hydrogen from reaching the lower flammability limit in the vicinity of an igniting spark. The lower flammability limit of hydrogen is 4% at room temperature, while the lower limit for self-sustaining combustion (in the absence of a sustained ignition source) is 8% [3]. The minimum ignition energy is so low, that ignition could be caused by hot surfaces or low level electrical discharges present in the vent fans, lighting, or in the electronics on the fuel cell racks themselves. This means that the hydrogen is likely to burn at very low concentrations before it has completely flooded the compartment.

If ignition happens early (at the 4% lower flammability limit), the resulting combustion may be little more than an instantaneous burst of flame, possibly followed by a torch of fire sourced at

the leak, and not cause much damage to systems outside of the flame, and not affect surrounding spaces. The damage to surrounding surfaces is mitigated by the facts that hydrogen flames have a low radiant emissivity due to the absence of carbon in the flame, and also water vapor in the air effectively absorbs infrared radiation coming from the product water in hydrogen flames.

If the hydrogen concentration somehow reached a higher level, subsequent ignition would be more severe. Since hydrogen is very buoyant, it may pool at the top of the compartment and increase its concentration before encountering an igniting spark, which would not necessarily be present in the overhead of the fuel cell room. The maximum amount of hydrogen that could be in the fuel cell room if it were 75% flooded (75% is the upper flammability limit) is still only about 10 kg, which would release about 1200 MJ of energy if burned. For comparison, this is about the same amount of energy that is released from burning 9 gallons of gasoline.

Score

P = 1, S = 5, R = 5

Mitigating Actions

If the installed safety measures are operating properly, an uncontrolled leak will not lead to hydrogen reaching the lower flammability limit. The fuel cell room will have redundant hydrogen detection equipment that is designed to cut off the hydrogen fuel supply in the event of the detection of hydrogen, typically set to detect at 10% of the lower flammability limit of 4%. The fuel cell electronics will also immediately and automatically be powered down along with any equipment not rated for Zone 1. Also, fuel cell room ventilation is always in operation and will immediately remove any hydrogen that is in the space following its release and detection. If the ventilation system fails, hydrogen supply to the room will be cut off (see 3.3.2). Given the very high amount of ventilation provided in the fuel cell room, the leak would have to be quite large for the hydrogen concentration to reach the lower flammability limit.

3.2 Hydrogen Tank

3.2.1 Overfill

Description

Overfill of the hydrogen tank would lead to venting into the atmosphere. This could occur during bunkering operations at the dock. Some specific causes of overfill could be operator error, or failure of automatic high level shutoffs.

Score

P = 2, S = 1, R = 2

Mitigating Actions

Overfill should be prevented by attentive bunkering operators and redundant level sensors in the tank to alert the operator when the tank has been filled.

Furthermore, the hydrogen tank vent is designed to vent the hydrogen far enough away from any hazardous zones that it is not a safety concern.

3.2.2 Underfilled

Description

An under filled hydrogen tank that reached ambient temperatures would require a considerable amount of additional fuel at cryogenic temperatures to bring the tank temperature down before it would be able to contain liquid. The additional hydrogen would vent into the atmosphere out of the vent stack which is located some distance away from ignition sources.

Score

P = 1, S = 1, R = 1

Mitigating Actions

The hydrogen tank vent is designed to vent the hydrogen far enough away from any hazardous zones that it is not a safety concern.

3.2.3 Gunfire

Description

All systems that are vulnerable to gunfire are redundant, with the exception of the fuel tank. The fuel tank may also be the most likely target because it is large and on top of the vessel.

It has been determined through consultation with LH₂ tank operators that a typical rifle is unlikely to be able to penetrate the two layers of steel (3/8" thick inner stainless steel cylindrical liner surrounded by a 1/4" thick carbon steel cylindrical shell) that constitute the tank. A higher powered military-style rifle may be able to penetrate the tank if the shot hit the surface perpendicularly. This could lead to loss of vacuum of the containment vessel and a moderate leak of hydrogen onto the upper deck.

Score

P = 1, S = 5, R = 5

Mitigating Actions

The structure of the tank mitigates the likelihood that penetration can occur. A partial screen around the tank also drastically reduces the possibility of a perpendicular direct hit from gunfire from the shore.

3.3 Fuel Cells

3.3.1 Failure

Description

If a fuel cell were to fail, it would cease consuming hydrogen. If one individual fuel cell, or a rack of fuel cells stopped functioning, two things would happen.

First, there would be a minor loss of power (0.6% for one cell failure, 2.5% for one rack failure). The reduction in power by 2.5% would cause an almost inconsequential decrease in speed. The vessel might be 1-2 minutes late.

Secondly, there would be an increase in back pressure in the hydrogen supply line due to reduced demand. This would be detected within the fuel cell rack, and would be followed by the closing of an automatic shutoff valve to prevent flow of hydrogen through the malfunctioning cell. Each fuel cell rack has a pressure regulating valve that automatically adjusts the flow into the fuel cells based on demand. If this shutoff is not functional and a significant amount of hydrogen escapes into a fuel cell room, the hydrogen detection system in that room will shut down all of the fuel cells in that room.

Therefore, no fuel cell failure scenario is a risk to safety.

Score

P = 1, S = 1, R = 1

Mitigating Actions

The quantity of fuel cells / fuel cell racks means that a single failure results in a small reduction in speed that can be managed until the next opportunity to service the malfunctioning cell. Online continuous monitoring of fuel cell status is designed to detect problematic fuel cells prior to failure.

Redundant supply line shutoffs prevent hydrogen from escaping into hazardous spaces in any significant quantity.

3.3.2 Ventilation Failure

Description

Air is required for the fuel cells to operate, and a large amount of air is ducted into the fuel cell room. If this supply were to fail, several hazardous conditions could result.

If the fuel cell room ventilation was to fail and there were a hydrogen leak, any hydrogen that may have leaked into the space would not be quickly dispersed to the exterior of the vessel. More importantly, however, fuel cell ventilation failure would cause oxygen in the space to be consumed very rapidly and create an unsafe environment for personnel.

The Occupational Safety and Health Administration defines the safe level of oxygen for breathing as 19.5% by volume. The natural oxygen content of air by volume is 20.9%. Natural ventilation would occur as oxygen is removed from the air, but the oxygen would be replaced by mostly atmospheric nitrogen and would still be below the safe low level of oxygen in a matter of seconds.¹ The fuel cells would also be unable to develop full power as the oxygen was removed from the air.

A simultaneous failure of ventilation, a hydrogen leak, and a failure of shutoff of electrical components due to hydrogen detection could lead to a fire, but such an event would be very unlikely outside of a major damaging event.

Score

P = 2, S = 5, R = 10

Mitigating Actions

If ventilation to one fuel cell room is lost, the hydrogen supply valve to that room is automatically shut. If there is a leak at the same time, this action limits the amount of hydrogen that could leak into the room to that only remaining in the piping, which keeps the maximum attainable hydrogen concentration below the lower flammability limit, and the fuel cells will stop consuming hydrogen and oxygen.

In the unlikely event of ventilation failure and failure of the hydrogen supply shutdown, the oxygen in the space may be consumed until dangerously low levels are present. Personnel may decide to enter the fuel cell space to assess the situation, so it is important to ensure that oxygen levels are safe by using oxygen level detectors.

3.4 Batteries

3.4.1 Overcharge/Failure

Description

Battery overcharge or failure could possibly lead to a fire in the battery compartment in the hold. Spread of this fire to other spaces, such as the passenger cabin, is unlikely due to lack of combustible materials in the battery compartment. However, if the fire were to spread to the passenger cabin, it could cause injury to passengers and/or become a source of damage and ignition to hydrogen fuel systems. Additionally, the spread of smoke and fumes from battery combustion could pose injury risk to passengers and crew.

Score

P = 1, S = 5, R = 5

Mitigating Actions

The way to prevent battery overcharge is through battery type selection and thorough and robust system design. In the detail design phase, the system integrator will ensure that the battery management system is designed to prevent a charge that is too high during any mode of operation. The battery management system will monitor charge and discharge current, as well as resulting battery cell temperature. This provides feedback information to the battery management system to verify battery performance.

During detail design, careful attention will be paid to the path available for venting smoke and combustion products. Additionally, the choice of insulation and firefighting measures will be examined.

3.4.2 Fire on Upper Deck

Description

A fire on the upper deck is of concern because of the possibility of damage to the LH₂ tank and possible release of hydrogen. Such a fire could have its source in the passenger cabin, fuel cell room, or be due to a leak directly from the LH₂ tank itself. If the LH₂ tank is exposed to a small fire, the superinsulation of the tank is likely to be sufficient to prevent unmanageable hydrogen boil-off, but any boil-off would be vented to a safe location as usual. A severe fire could cause a

complete structural failure of the tank and subsequent release of the fuel which would then ignite. The danger to passengers or crew on the vessel is probably low due to the buoyancy of the hydrogen. Ignition of all of the contents of the fuel tank would produce a large flame that would rapidly rise hundreds of feet into the air away from persons on board. Containment of this sort of fire is not practical since it would likely last less than 10 seconds [3] in the event of complete failure and spillage. It is possible that if there were high downdraft winds, or a torch that was not directed upwards, that the flames could reach locations on the vessel that had other systems, crew, or passengers. It is much more likely, however, that the hydrogen would quickly dissipate upward and any fire could only be a danger to structures above the ferry, such as a bridge.

Score

P = 1, S = 3, R = 3

Mitigating Actions

Appropriate selection of components considering the service conditions (cryogenic temperatures, hydrogen, marine environment), following the established codes, and using designs and suppliers with proven usage will mitigate against component failure.

Automatic shutoff will be triggered by an abnormal loss of pressure or hydrogen level and by hydrogen and flame detectors in the vicinity.

The only way to prevent the sort of damage needed to cause a large leak would be to reinforce the tank or other components or enclose the tank or other components in a protective bulkhead. Neither of these options is currently being considered as the probability of this occurrence is considered to be very low given the mitigation practices discussed above and the location of the tank and components on the top deck, which is a restricted personnel area, and protected from external impacts since it is far from the waterline and in the lateral center of the vessel. In addition, enclosing this equipment is not desired because it would increase the risk of forming a hazardous environment.

In case of a small fire, the tank has built-in superinsulation to prevent unmanageable heating and boil off of the LH₂. If the insulation is compromised, the heating of the LH₂ will increase the pressure in the tank to the point where the boil-off valve opens and the contents are released in a controlled manner out of the vent mast to a safe location.

3.5 Other Propulsion Systems

Description

Some other systems that are directly involved in propulsion power are cooling water, fuel supply, electrical conversion, and shafting. The vessel is designed so that if any one of these components were to fail, only half of the vessel propulsion would be unavailable. The other half of the power would be available to drive at least one of the waterjets at 100% power, or possibly still be able to drive both at 50% power, which would be preferable from a maneuvering standpoint.

Score

P = 1, S = 1, R = 1

Mitigating Actions

While the probability of these events happening is hard to predict, the full redundancy of the power supply is all that is needed to mitigate the consequences of such an event. The vessel will be able to make a moderate speed and return to port, which would cause an inconvenience for passengers, and the vessel would then be taken out of service for as long as needed to make repairs. Battery power is sufficient to run navigation and lighting equipment for a couple of hours, but not enough to power the vessel for more than a few seconds following loss of fuel cell power.

3.6 Collision

Description

Collision is always a possibility on a busy route such as that intended for this vessel. However, the unique design of the vessel does not contribute to an increased likelihood or increased severity of such an accident. The forward end of the vessel, which would be most likely to experience collision damage, does not contain any vital propulsion systems. The fuel tank is on the top deck, and the fuel piping and fuel cells are on the main deck away from the sides. This means that they are less likely to be damaged from collision, even if the impact came from another vessel from the side. For purposes of assessing collision risk, this vessel can be treated as the same as any other high speed catamaran.

Score

P = 2, S = 20, R = 40

Mitigating Actions

Collision prevention is a result of good navigation practices, attentive operators, and adequate design of the vessel to applicable regulations that are designed to mitigate damage to the vessel in the event of such a collision. The presence of a hydrogen system does not increase the severity of a collision for all but the most momentous collision that penetrates far enough in the vessel to damage the fuel systems. Any collision severe enough to possibly damage the fuel system would probably already be severe enough to cause the vessel to be lost.

The vessel will be designed to ABS High Speed Craft Code, which includes structural design rules that consider the effects of collision damage.

3.7 Fuel Spill During Bunkering

Description

Twice during every operating day, bunkering occurs which involves the transfer of hydrogen fuel and an inert gas such as helium or nitrogen through pipes and hoses to precool and inert the piping, and refuel the vessel. These operations will be performed by members of the crew and possibly other staff who work at the shoreside facilities. Ideally, the only releases are of a moderate and controlled amount of vaporized hydrogen and nitrogen/helium into the atmosphere.

If the bunkering procedure is not followed, or hardware is unknowingly malfunctioning, then release of large quantities of liquid or vaporized hydrogen is possible, which would then pose a fire hazard either on the vessel, or at the shoreside facilities. Damage to structures could also occur if liquid hydrogen is spilled.

Score

P = 2, S = 20, R = 40

Mitigating Actions

A well planned bunkering procedure with adequately trained crew is the best way to prevent major spills from occurring. Relative to the hazards that exist for the vessel while underway, accidental damage to the equipment is not very likely because bunking occurs at a stationary, controlled facility. Operator error is far more likely to be the cause of spills. To further mitigate the risk of error, a second person employed as a "spotter" or "fire watch" may be utilized who would be near an emergency shutoff switch that could be used in the event of a visual spot of a spill or fire. Adequate firefighting equipment should also be installed at the facility.

Automatic shutoffs may also be used when high concentrations of hydrogen or fire are detected at the bunkering facility. These may be less effective in a large exterior location than on board the ferry in an enclosed location. Further study is needed as to their effectiveness.

4 REFERENCES

- [1] ABS, Guidance Notes on Failure Mode and Effects Analysis (FMEA) for Classification, May 2015.
- [2] ABS, Risk Assessment Applications for the Marine and Offshore Oil and Gas Industries, June 2000.
- [3] L. Klebanoff, "Assessing Risk of Fire to the Aluminum Deck in the SF-Breeze (Powerpoint Presentation)," Sandia National Laboratories, November 23, 2015.

ⁱ The % by mass of oxygen in air is 23.1% and the density of air is 1.225 kg/m³. Assuming that 40% of the 201.8 cubic meter fuel cell room is occupied by fuel cells or piping, this means that there is about 34.3 kg of oxygen in the compartment. At 4 MW of full power demand, the fuel cells consume 329 kg of hydrogen per hour. For each mole of hydrogen consumed, 0.5 mole of oxygen is consumed. The molar mass ratio of hydrogen to oxygen is 1.0079/15.9994=0.063. So the amount of oxygen consumed per hour is 329/0.063/2=2611 kg. That means that it would only take 34.3/2611*60*60=47 seconds to consume all of the oxygen in the compartment.

CONFIDENTIAL AND PROPRIETARY PROPERTY OF
Elliott Bay Design Group LLC
 MAY NOT BE USED FOR CONSTRUCTION OR PROVIDED TO
 ANY THIRD PARTIES WITHOUT PRIOR WRITTEN CONSENT.
 ©2016 ELLIOTT BAY DESIGN GROUP.

HAZARDOUS ZONES KEY	
HATCH	ZONE DESIGNATION
	ZONE 0
	ZONE 1
	ZONE 2

REVISION HISTORY					
REV	ZONE	DESCRIPTION	DWN	DATE	APVD

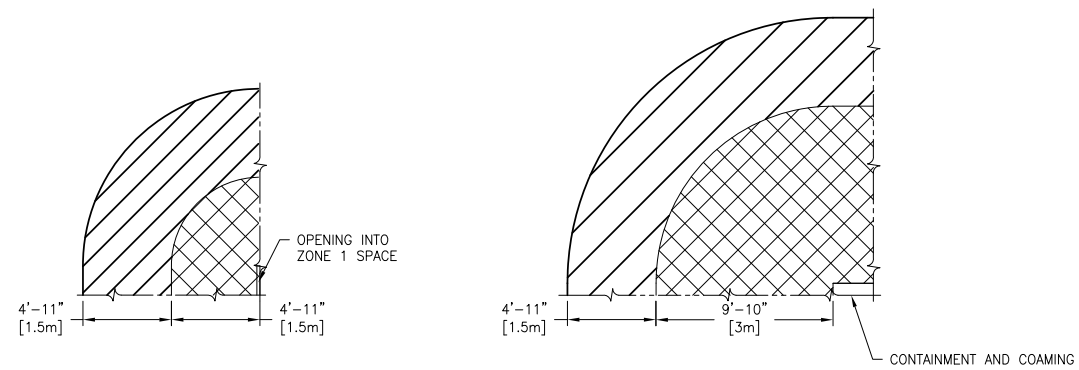
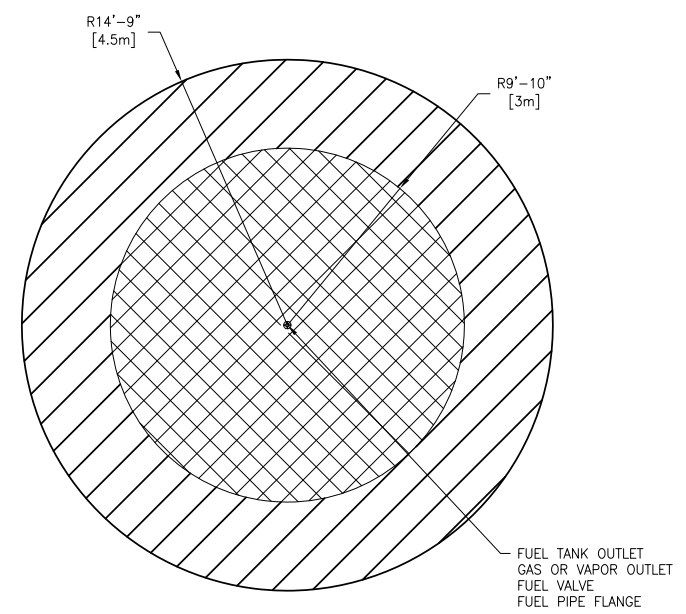

LEGEND

- GENERAL NOTES**
- THIS DRAWING IS PART OF A PRELIMINARY PACKAGE THAT HAS BEEN DEVELOPED TO THE CONCEPT LEVEL. IT IS NOT INTENDED FOR CONSTRUCTION AND HAS RESERVATIONS THAT WILL REQUIRE FURTHER DEVELOPMENT.
 - THIS CONCEPT DESIGN HAS BEEN DESIGNED TO MEET THE STANDARDS, RULES AND REGULATIONS OF THE FOLLOWING PUBLICATIONS IN PART OR IN FULL: 46 CFR SUBCHAPTER T, ABS GUIDE FOR BUILDING AND CLASSING HIGH-SPEED CRAFT, RESOLUTION MSC.391(95) - ADOPTION OF THE INTERNATIONAL CODE OF SAFETY FOR SHIPS USING GASES OR OTHER LOW-FLASHPOINT FUELS (IGF CODE).
 - THIS DRAWING SHOWS THE ARRANGEMENT OF HAZARDOUS ZONES FOR THE VESSEL BASED ON HAZARDOUS ZONES REQUIREMENTS.
 - THE FOLLOWING ZONE DEFINITIONS WERE USED (REF 5):
 - ZONE 0: AN AREA IN WHICH AN EXPLOSIVE GAS ATMOSPHERE IS PRESENT CONTINUOUSLY OR FOR LONG PERIODS OR FREQUENTLY. APPLIED ONLY TO LH2 RELATED SPACES.
 - ZONE 1: AN AREA IN WHICH AN EXPLOSIVE GAS ATMOSPHERE IS LIKELY TO OCCUR DURING NORMAL OPERATION OCCASIONALLY. APPLIED ONLY TO LH2 RELATED SPACES.
 - ZONE 2: AN AREA IN WHICH AN EXPLOSIVE GAS ATMOSPHERE IS NOT LIKELY TO OCCUR DURING NORMAL OPERATION, BUT, IF IT DOES OCCUR, WILL PERSIST FOR A SHORT PERIOD ONLY. APPLIED ONLY TO LH2 RELATED SPACES.
 - ALTERNATE DIMENSIONS IN BRACKETS ARE METRIC DIMENSIONS, WHICH PROVIDE A MORE DIRECT COMPARISON TO RELEVANT REGULATION REQUIREMENTS FOR DISTANCES OF HAZARDOUS ZONES.
 - INTERIORS OF LH2 TANK, PIPING, AND VENTING ARE ZONE 0 HAZARDOUS SPACES.

- REFERENCES**
- 15051-001-101-1 GENERAL ARRANGEMENT
 - MSC.391(95) - INTERNATIONAL CODE OF SAFETY FOR SHIPS USING GASES OR OTHER LOW-FLASHPOINT FUELS (IGF CODE)
 - IEC 60092-502 - ELECTRICAL INSTALLATIONS IN SHIPS
 - COMPARISON OF LH2 AND LNG PROPERTIES WITH A FOCUS ON SAFETY - SANDIA NATIONAL LABORATORIES
 - IEC 60079-10 - ELECTRICAL APPARATUS FOR EXPLOSIVE GAS ATMOSPHERES

Elliott Bay Design Group
 Seattle • New Orleans • Ketchikan
 CLIENT: **SANDIA NATIONAL LABORATORIES**
 LIVERMORE, CALIFORNIA
 PROJECT: **SF-BREEZE FERRY FEASIBILITY STUDY**

HAZARDOUS ZONES PLAN

SIZE	D	DWG NO.	15051-001-101-2	REV	-
SCALE	3/16"=1'-0"	FILE NAME	15051-001-101-2-	SHEET	1 OF 3
DWN	EMT	MOD		APVD	
			CML		
				APVD DATE	2/12/16

HALF SIZE PRINT



6

5

4

3

2

1

6

5

4

3

2

1

CONFIDENTIAL AND PROPRIETARY PROPERTY OF
Elliott Bay Design Group LLC
 MAY NOT BE USED FOR CONSTRUCTION OR PROVIDED TO
 ANY THIRD PARTIES WITHOUT PRIOR WRITTEN CONSENT.
 ©2016 ELLIOTT BAY DESIGN GROUP.

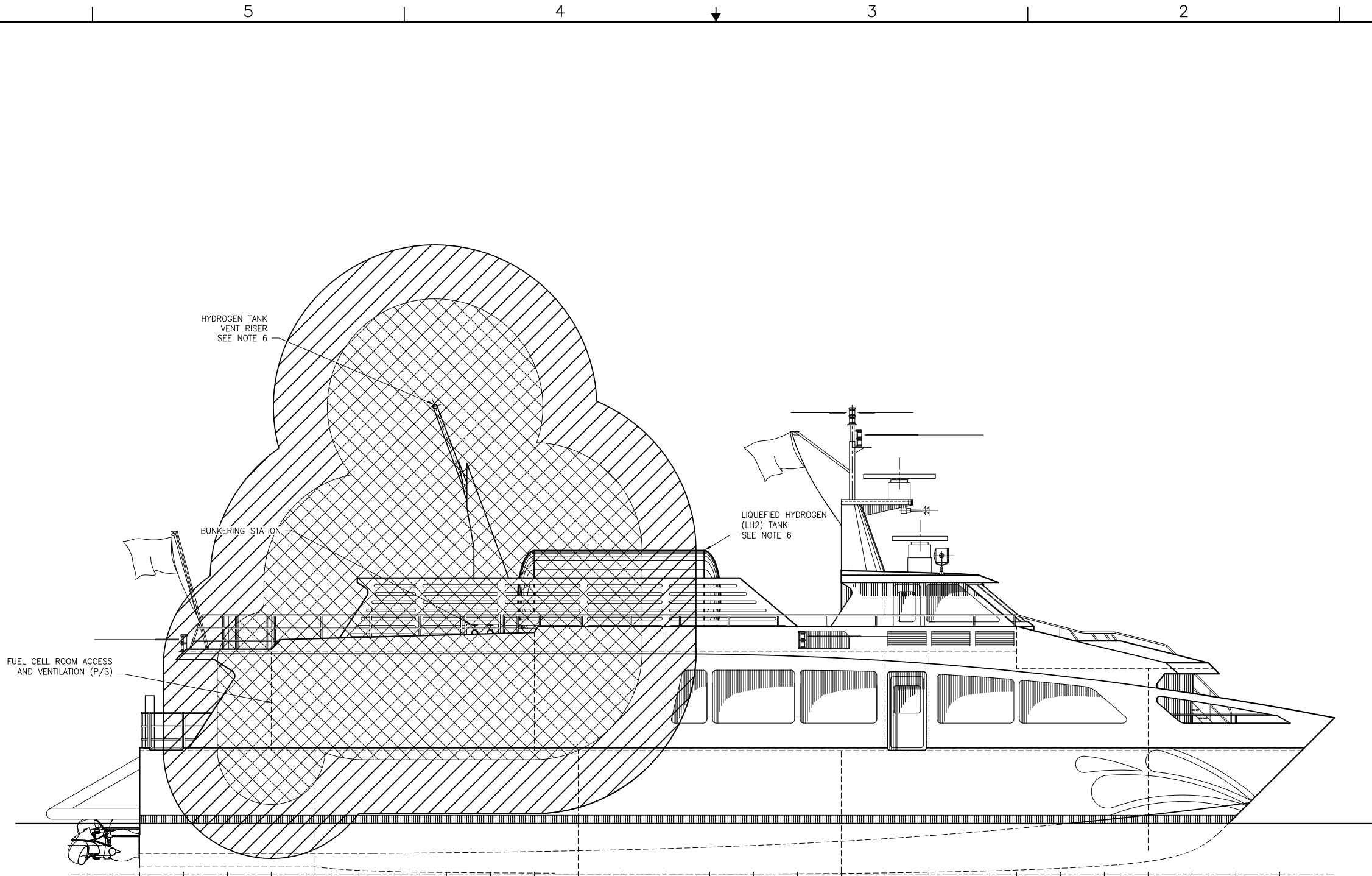

PROFILE 2-3B
 EXTERIOR HAZARDOUS ZONES
 NOTE 6



CONFIDENTIAL AND PROPRIETARY PROPERTY OF
Elliott Bay Design Group LLC
 MAY NOT BE USED FOR CONSTRUCTION OR PROVIDED TO
 ANY THIRD PARTIES WITHOUT PRIOR WRITTEN CONSENT.
 ©2016 ELLIOTT BAY DESIGN GROUP.

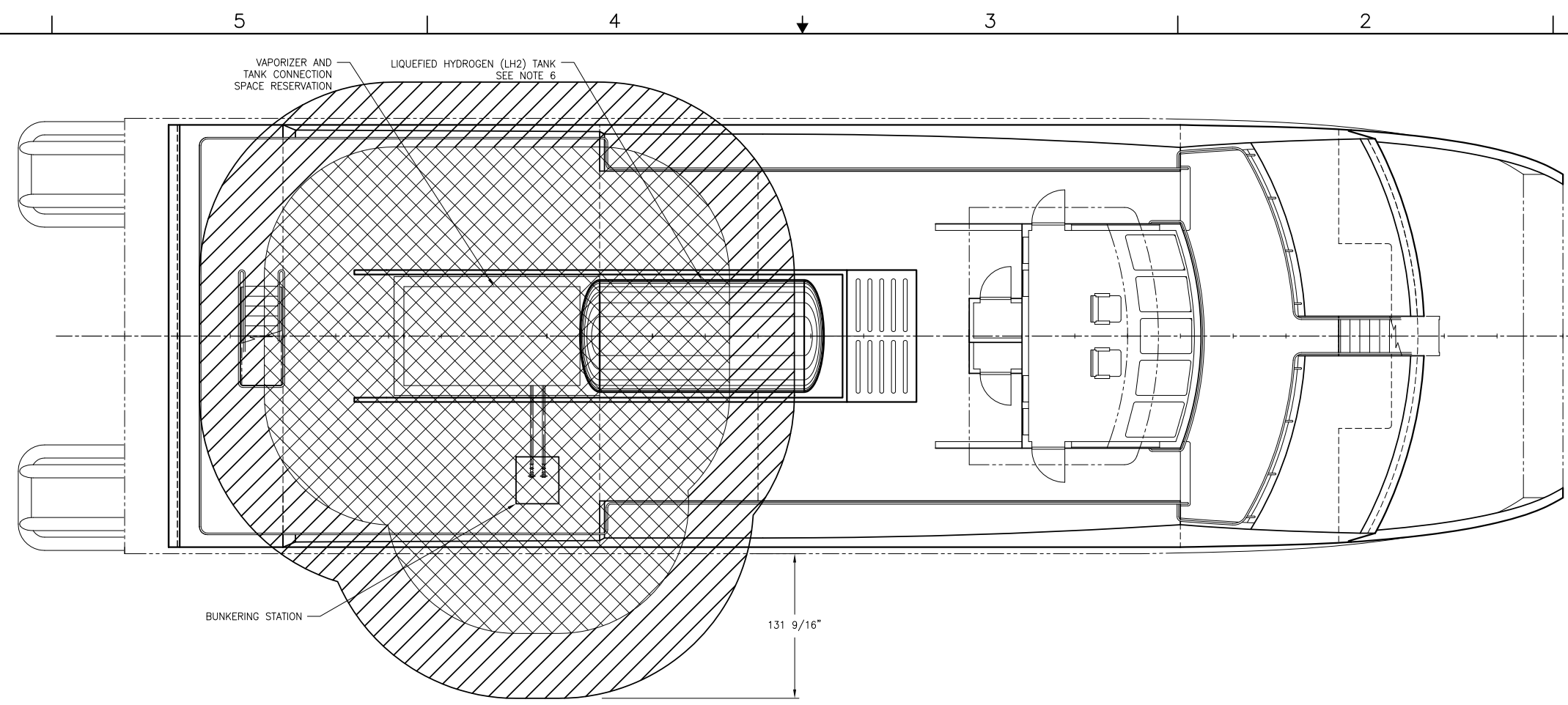

PLAN 3-3C
 UPPER DECK HAZARDOUS ZONES

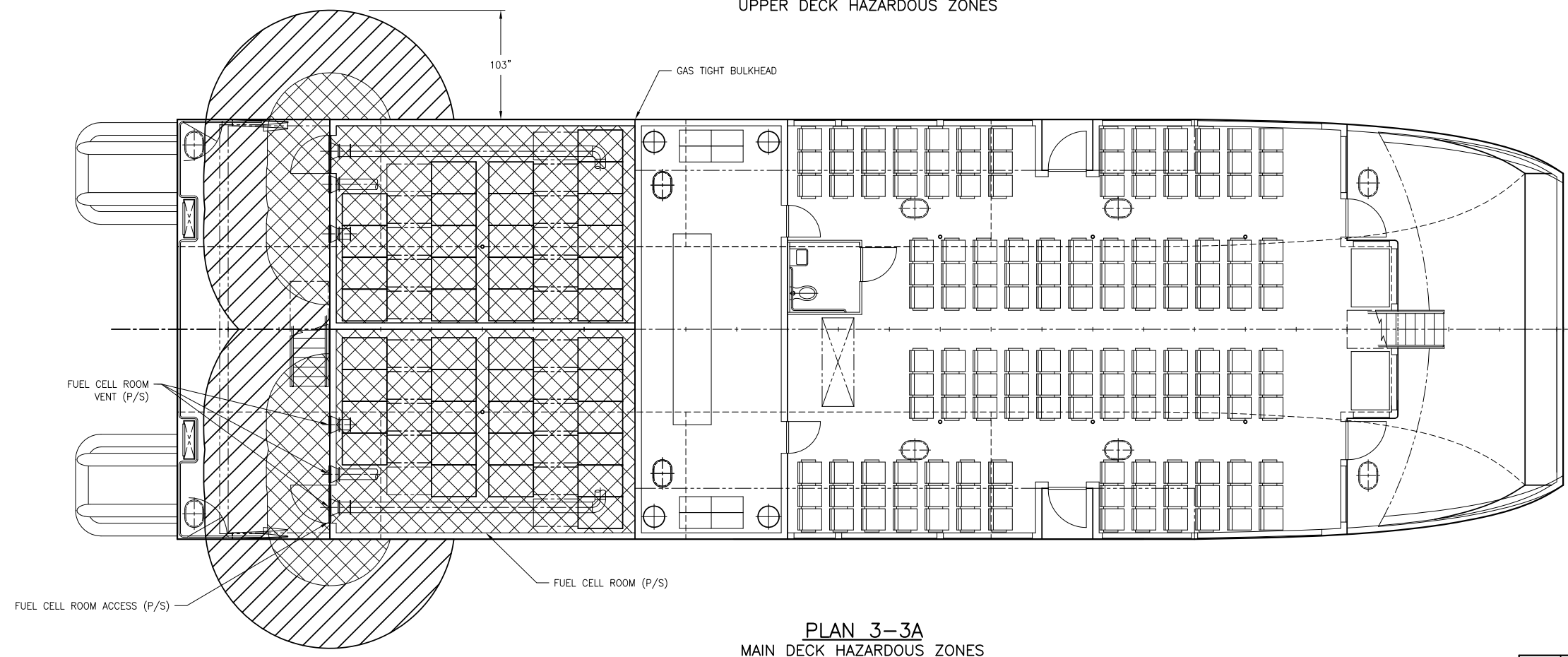

PLAN 3-3A
 MAIN DECK HAZARDOUS ZONES



HALF SIZE PRINT

SIZE	D	DWG NO.	15051-001-101-2	REV	-
SCALE	3/16" = 1'-0"	FILE NAME	15051-001-101-2-	SHEET	3 OF 3

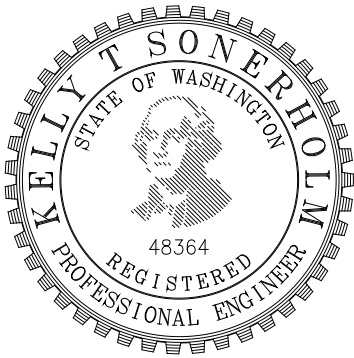

SF-BREEZE FERRY FEASIBILITY STUDY

Parametric Cost Estimate

Prepared for: Sandia National Laboratories • Livermore, CA

Ref: 15051-001-043-1

Rev. -

February 12, 2016

PREPARED BY

Elliott Bay Design Group
5305 Shilshole Ave. NW, Ste. 100
Seattle, WA 98107

GENERAL NOTES

1. The following is an estimate of construction cost for the SF-BREEZE High Speed Hydrogen Ferry.
2. Operating Costs are not included in this estimate.
3. Certain components, particularly the fuel cells, which are associated with the hydrogen fuel system are not widely in use, therefore, actual pricing for this application may be subject to change.

REVISIONS

REV	DESCRIPTION	DATE	APPROVED
P1	Preliminary Issue	1/21/16	KTS 48364
-	Initial Issue	2/12/16	KTS 48364

TABLE OF CONTENTS

	PAGE
1 Purpose	1
2 Procedure	1
2.1 Group Descriptions	1
2.1.1 Group 000 – Project Management & Administration	1
2.1.2 Group 100 – Hull	1
2.1.3 Group 200 – Propulsion Machinery	1
2.1.4 Group 300 – Electrical	1
2.1.5 Group 400 – Navigation	1
2.1.6 Group 500 – Auxiliary	1
2.1.7 Group 600 – Outfit	1
2.1.8 Group 700 – LH ₂ Related Systems	2
2.1.9 Group 800 – Engineering	2
2.1.10 Group 900 – Construction Services	2
3 Conclusion	2
3.1 Labor Rates	2
3.2 Comparison to Similar Diesel Boat Cost to Build	2
3.3 Potential Cost Reduction	3
4 Calculations	4

1 PURPOSE

This report provides a construction cost estimate for the SF-BREEZE FERRY. The subject vessel is a 109 ft x 33 ft x 11.25 ft high-speed catamaran passenger vessel which is powered by hydrogen fuel cells.

2 PROCEDURE

The US Navy Ship Work Breakdown Structure (SWBS) is used to separate all of the ship's components into groups. For each group, a material cost/lb, and a labor hours/lb is estimated using knowledge of past projects. These parametric values have been modified to suit the unique features and design challenges for this vessel. Additionally, more specific estimates were obtained for major components such as the hydrogen fuel cells. The standard labor cost is \$80/hr except where noted. One Long Ton (LT) = 2240 lb.

2.1 Group Descriptions

2.1.1 Group 000 – Project Management & Administration

This group represents the overhead costs of acquiring the vessel not directly related to its construction. It is estimated at 5% of the total labor hours to build the vessel. This category uses a labor rate of \$96/hr rather than \$80/hr.

2.1.2 Group 100 – Hull

This group represents the material and labor costs to build the aluminum hull of the vessel. It is based on a cost of aluminum of \$5,940/LT and labor hours of 448 hours/LT.

2.1.3 Group 200 – Propulsion Machinery

This group includes all propulsors, propulsion motors, and electrical conversion equipment. It uses a cost of \$268,800/LT and labor hours of 110 hours/LT.

2.1.4 Group 300 – Electrical

This group includes all switchboards and electrical controls which are not directly involved in the transmission of electrical power to the propulsors. It uses a cost of \$112,000/LT and labor hours of 78.4 hours/LT.

2.1.5 Group 400 – Navigation

This group includes all electronics and bridge equipment used for navigation and communication. It uses a cost of \$145,600/LT and labor hours of 450 hours/LT.

2.1.6 Group 500 – Auxiliary

This group includes piping systems, HVAC, and other non-propulsion related mechanical systems. It uses a cost of \$33,600/LT and labor hours of 150 hours/LT.

2.1.7 Group 600 – Outfit

This group includes seating, joinery, and other non-mechanical items and structures. It uses a cost of \$33,600/LT and labor hours of 200 hours/LT.

2.1.8 Group 700 – LH₂ Related Systems

This group includes only two items: The hydrogen Fuel Cells, and the Liquefied Hydrogen Fuel Tank. These items are expensive and were not suitable to include in the other parametric groups so cost estimates were acquired for each individually.

The cost of the hydrogen fuel cells is estimated to be \$2,500 per kW of power. With 4,920 kW, this brings the fuel cell total to \$12.3 million. The LH₂ tank is roughly estimated to cost around \$850,000.

2.1.9 Group 800 – Engineering

This group includes the cost to perform a detailed design and provide engineering support. It is estimated at 10% of the labor hours to construct the vessel, and uses a labor rate of \$144/hr rather than \$80/hr.

2.1.10 Group 900 – Construction Services

This group includes other labor hours needed in construction of the vessel that are not directly related to the construction. It is estimated at 14% of the total labor hours to construct the vessel.

3 CONCLUSION

The estimated cost of construction is \$29,220,000. See the Calculations section for further information.

3.1 Labor Rates

Labor rates vary by area of the country, and more importantly, by the availability of the shipyard. Shipyards which are currently experiencing shortages will often be willing to bid under the expected rates.

The most current information available to EBDG suggests that a typical labor rate for the Pacific Northwest is about \$78 per hour, while in the Gulf Coast it is about \$69 per hour. With a total labor cost of about \$3.58 million if the vessel were built in the Pacific Northwest, it is expected that about \$410,000 could be saved by constructing in the Gulf Coast, or about 1.4% of the current construction cost estimate.

3.2 Comparison to Similar Diesel Boat Cost to Build

For a rough estimate of what a new build diesel vessel of the same speed and capacity would be, the following assumptions are made:

- Elimination of the LH₂ equipment weight/cost item (reduction of 34.5 LT)
- Increase of the propulsion machinery weight item by 6.5 LT to make up the difference such that the total lightship weight is now equal to that of the M/V VALLEJO (90.7 LT)

The resulting cost is \$15.2 million.

Information obtained by EBDG for the cost estimate for a larger ferry, similar to the SOLANO (lightship weight of about 141 LT) indicates that a new vessel of that size would cost about \$21

million, which is similar but slightly less in cost per unit weight, which makes sense due to the economies of scale.

In conclusion, a diesel vessel of similar proportions to the SF-BREEZE would probably be around \$15.2 million.

3.3 Potential Cost Reduction

As this is a very preliminary estimate, the cost is subject to inaccuracies that would improve with design refinement. This means that the design margins included in the estimate could be eliminated as detailed cost information is obtained.

Finally, the most expensive element of the boat is the LH₂ system, which amounts for nearly half of the cost. As fuel cells are still a developing technology, it is possible that costs will decrease as production rises and the process efficiency is improved and as economies of scale are realized.

One design feature that has the potential to reduce vessel drag and, therefore, reduce the required number of fuel cells, is the addition of a lifting device. A lifting device properly designed and installed on a high speed vessel has the potential to reduce the drag by as much as 10%. A 10% reduction in drag results in a similar reduction of about 10% of the required fuel cells, which is about \$1.3 million.

4 CALCULATIONS

- 1) This estimate is intended for new construction of ONE vessel.
- 2) This vessel is assumed to be built in the US (most likely the Pacific Northwest)
- 3) Labor rates assume work is done in the Pacific Northwest
- 4) This estimate is intended for budgeting/feasibility purposes ONLY.
- 5) Costs are organized in accordance with the EBDG interpretation of the SWBS System.
- 6) Weights are taken from 15051-070.1 Design Study Report Calculations.xlsx.
- 7) Non-trade labor rates are as follows:
 - PM & Admin = 120% of Labor
 - Engineering = 180% of Labor

Inputs

Current Vessel		Value Unit	
Length	109.00 <i>ft</i>	Vessel Type	Ferry
Beam	33.00 <i>ft</i>		
Draft	4.58 <i>ft</i>		
Light Ship Δ	119.82 <i>LT</i>		
Structure Weight	40.00 <i>LT</i>		
Shipyard		Value Units	
Labor Rate	\$80.00 / <i>hr</i>		
Material Mark-Up	17.0%	000 - PM & Admin	5.0%
Labor Margin	10.0%	800 - Engineering	10.0%
Contingency	10.0%	900 - Construction Services	14.0%

Calculations

SWBS COST GROUPS	Weight in LT	\$/LT	HRS/LT	\$ MATERIAL + Mark-up	LABOR HRS	LABOR COST
000 - PM & ADMIN					1,646	\$ 158,015
100 - HULL	30.5	5,936	448.00	\$ 212,142	13,684	\$ 1,094,752
200 - PROP MACH'Y	12.3	268,800	110.00	\$ 3,868,301	1,353	\$ 108,240
300 - ELECTRICAL	21.8	112,000	78.40	\$ 2,854,051	862	\$ 68,992
400 - NAVIGATION	2.0	145,600	450.00	\$ 340,704	900	\$ 72,000
500 - AUXILIARY	11.0	33,600	150.00	\$ 432,432	1,650	\$ 132,000
600 - OUTFIT	6.0	33,600	200.00	\$ 235,872	1,200	\$ 96,000
700 - LH2 EQUIP	34.5	N/A	200.00	\$ 13,150,000	6,898	\$ 551,879
800 - ENGINEERING					2,655	\$ 382,295
900- CONST. SERVICES				\$ 238,305	3,717	\$ 297,341
Totals	118.12			\$ 21,331,807	34,566	\$ 2,961,514

Output

Labor & Material Sub-Total	\$24,293,321
Material & Labor Margin @ 10%	\$2,429,332
Cost without Contingency =	\$26,722,654
Contingency	\$2,672,265
Total Vessel Construction Cost Estimate with 10% CONTINGENCY	\$29,394,919
Rounded Up Total	\$29,400,000

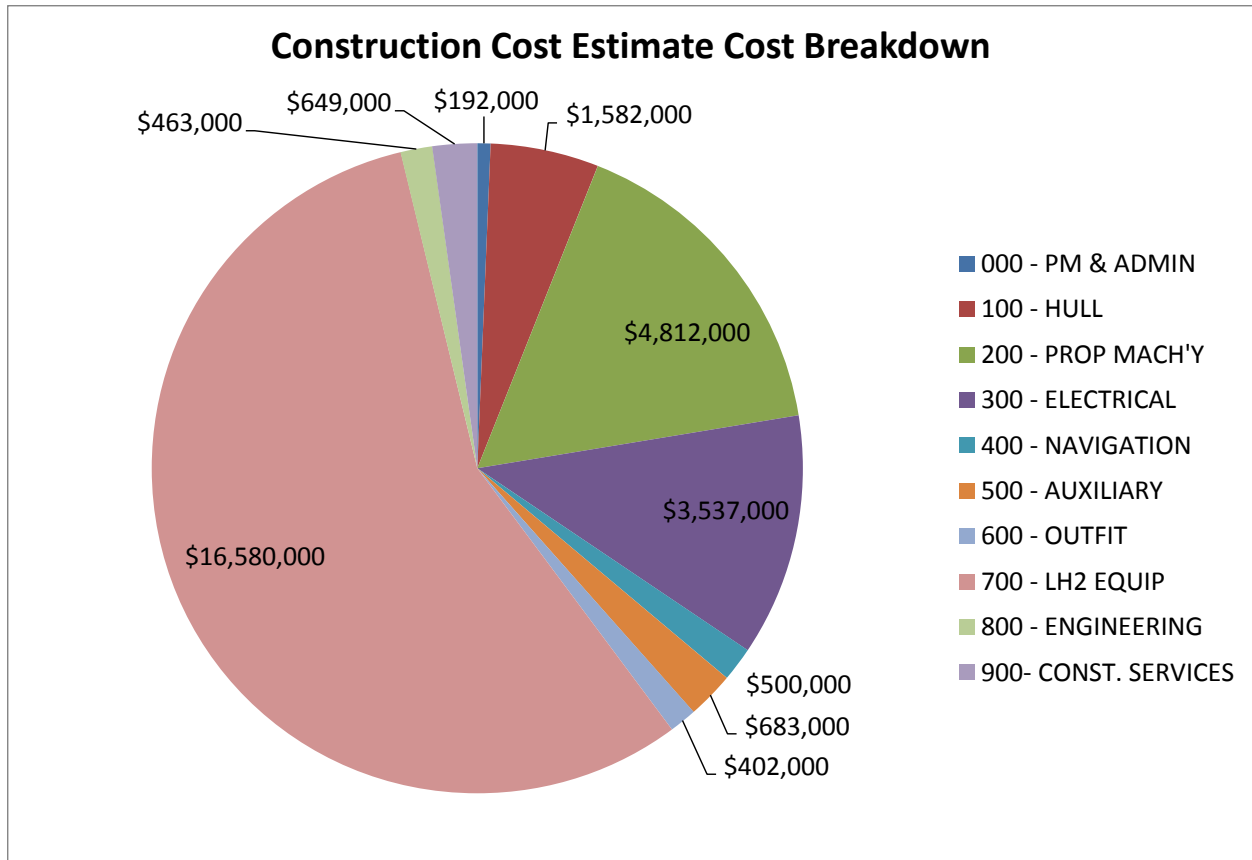

Appendix B

Vessel Design Approval in Principle (AIP) from the American Bureau of Shipping



PM/ELS/MKH/YT/BW
Project: 3661413
Tasks: T1481663, T1498982,
T1498984, T1498986 and T1498116

12 April 2016

Elliott Bay Design Group
5305 Shilshole Ave N.W., Suite 100
Seattle, WA 98107

Attention: Mr. Curt Leffers

Subject: J15051 SF-BREEZE Ferry
109ft x 33ft x 11.25 ft Catamaran Passenger powered by Hydrogen Fuel Cell
Maximum Number of Passengers: 150, Maximim GRT: 100T
USCG Subchapter T
Approval in Principal-Feasibility Study Level

Gentlemen:

We have your letter and emails dated 18 and 19 February 2016, respectively, submitting the documentation and plans for an 'Approval in Principal' (AIP) at the Feasibility Study Level for a Hydrogen Fuel Cell Powered Ferry. With regard thereto, we advise as follows:

The subject submittal has been reviewed for compliance with applicable requirements of the 2016 ABS Rules for Building and Classing Steel Vessels (SVR), the 2016 ABS Rules for High Speed Craft, the 2016 ABS Guide for Propulsion and Auxiliary Systems for Gas Fueled ships and the 2015 International Code of Safety for Ships using Gases or other Low-flashpoint Fuels (IGF Code). We have completed our review and have found that the proposed concept appears to comply with the intent of the Rules, Guides and regulations applicable to such a system and have no objection to our Approval in Principle of the concept provided the following comments are addressed when the design is more complete:

Electrical Review:

Dwg No: 15051-001-101-2, "Hazardous Zones Plan", Rev. -

- 1) The hazardous zones Plan is to be updated to include zones around the LH2 Tank (Type C) in accordance with 12.5 of the IGF Code.
- 2) Depending on the battery storage size and capacity, the hazardous zones plan is to include the zones for the battery storage location in accordance with 4-8-4/27.5.3 of the SVR.
- 3) A list/booklet identifying all electrical equipment installed in the hazardous area zones and the particulars for that equipment (Manufactures name, hazardous area classification, Certification, etc) as per 4-8-1/5.3.2 and 4-8-4/27.13 of the SV Rules. Also, note that



PM/ELS/MKH/YT/BW
Project: 3661413
Tasks: T1481663, T1498982,
T1498984, T1498986 and
T1498116

ATEX certified equipment is not accepted by the USCG as per USCG Marine Inspection Notice 01-12 dated 7 February 2012.

Structural review:

Dwg. No. 15051-001-101-1, Re. -, General Arrangement drawing

Dwg. No. 15051-001-101-2, Re. -, Hazardous Zones plan:

- 4) The aft most window of the passenger cabin should be removed since it is located within the hazardous zone.
- 5) The passenger cabin is extended forward of the collision bulkhead (Fr. 23) which typically is not acceptable. Further discussion or clarification is to be provided.
- 6) From the submitted drawing it is not clear if the P & S ventilation trunks used to serve the passenger cabin are passing through the hazardous area. If it so, a dedicated ventilation system serving the cabin is to be provided.
- 7) Notice boards are to be provided, prohibiting passengers entering the crew only stair and doors.

Dwg. No. 15051-001-168-1, Re. -, Preliminary Risk Assessment:

- 8) We note the provided preliminary/conceptual Risk Assessment and, more specifically, the discussion items related to tank leaks and consequences related to such an event. It is our understanding that in order to choose adequate fire protection/insulation as well as determining the necessity of providing shelter in way of the tank location, a more specific HAZID/HAZOP study should be conducted and provided at later date.
- 9) For the future design of the tank foundation and supporting structure, accelerations due to a collision are to be taken into account while designing the tank supporting structure.

Tonnage Review

Dwg. No. J15051-04M, Tonnage Memo:

- 10) In reference to your submittal, J15051-04M – “Tonnage Memo”, for the preliminary U.S. Regulatory subpart “C” tonnage calculations of the high-speed 109’ x 33’ x 8.25’ catamaran, the preliminary GRT is 91.76. Please note the following remarks concerning the calculations:
 - i) Underdeck – 72.31 – this tonnage is based on the submitted calculations in the referenced tonnage memo. A full set of frame drawings needs to be submitted and reviewed to confirm the underdeck tonnage.



PM/ELS/MKH/YT/BW
Project: 3661413
Tasks: T1481663, T1498982,
T1498984, T1498986 and
T1498116

- ii) 1st Tier – 3.73 – Fuel Cell (~FR 3 – 9) and Control Rooms (~FR 9 – 12) are exempt from tonnage as machinery space. The planned T/O's installed in the P/S fwd bulkhead (~FR 23) exempt the passenger space as open space (~FR 12 – 23). The P/S PFD lockers (~FR 23 – 24) go into the gross tonnage.
- iii) 2nd Tier – 15.72 – The fwd P/S enclosed section of Tier 2 (~FR 21 ¼ -24 ½) is included in tonnage. The Pilothouse (~FR 17 – 20 ¼) is exempt as wheelhouse and the P/S lockers (~FR 16 – 17) are included in gross tonnage. The Hydrogen tank (~FR 9 – 13) is included in the gross tonnage with the Vaporizers and Connections House (~FR 5 ¼ - 9) exempt as machinery space. The P/S Vent Trunks (~FR 9 ½ - 20) are exempted as light and air.

The above GRT of 91.76 is only preliminary and subject to change based upon a submitted full set of drawings, tonnage confirmation survey, and final review.

Mechanical and Piping Systems Review:

Dwg. No. 15051-001-050-1, Re. -, Speed & Powering Calculations;

Dwg. No. 15051-001-062-1, Re. -, Bunkering Procedure;

Dwg. No. 15051-001-070-2, Re. -, Design Study;

Dwg. No. 15051-001-168-1, Re. -, Preliminary Risk Assessment;

- 11) Details provided are minimum and not sufficient for a full review of the arrangements. However, we have reviewed the details as far as shown and advise that the following comments are to be addressed when the design is more complete:
 - a) A Risk Assessment (RA) shall be conducted as per Para 4.2, Part A of IMO Resolution MSC 391(95), the IGF Code. The RA shall be both qualitative as well as quantitative. The RA plan shall be submitted for review prior to conducting the RA.
 - b) We note that a Type C tank is used for the fuel storage which has inner plating of Stainless Steel and outer plating steel. The hull is of Aluminum. In this regard and as well as for other locations on the vessel where Aluminum is joined to steel or other dissimilar materials, special attention to be paid. In order to avoid excessive corrosion between the tank structure and adjoining aluminum structure, the suitable means are to be taken to avoid direct contact of faying surfaces of aluminum to other metals. Suitable non-wicking and non-water absorbing tapes or coatings are to be used. The use of explosion bonding may be considered depending on the mechanical and corrosion properties of the joint.

These conditions focus on highlighting major issues only. The AIP review process is not intended to assure that the drawings are 100% conformance with the Rules. Additional



PM/ELS/MKH/YT/BW
Project: 3661413
Tasks: T1481663, T1498982,
T1498984, T1498986 and
T1498116

comments may be raised during Classification design review at a later stage, if contracted. At that time, regulatory requirements of the flags (if applicable) and coastal state administrations should be addressed with the appropriate authorities where design features differ from typical practice for High Speed Craft, as ABS does not have the authority to grant regulatory equivalencies or exemptions without concurrence of the administration(s). We can assist with such contact, and attend meetings with yourselves and the regulatory bodies at your request.

If we may be of further assistance, please do not hesitate to contact Michael Haendler at (281) 877-6587 or Prasad Mantravadi at 281-877-6622 or Mr. Emil Shtaygrud at (281) 877-6952. Please refer to this letter date and above project no. when responding to this correspondence.

Very truly yours,

Roy H. Bleiberg
Vice President of Engineering
ABS Americas

By: _____

Emil L. Shtaygrud
Principal Engineer
Electrical and Piping Systems Group
Ship Engineering Department

Appendix C
Letters of Support



February 16, 2015

Joseph W. Pratt, Ph.D.
Energy Innovation Department
Sandia National Laboratories
7011 East Avenue
Livermore, CA 94551

Dear Joe:

Thank you for meeting with me and Jay Ach and Rich Berman last month. We enjoyed learning about your vision, with Red & White Fleet, to build a high-speed passenger ferry powered by hydrogen fuel cell technology for operation in the San Francisco Bay.

The vessel you described, if proved feasible and subsequently constructed by Red & White Fleet, would produce no greenhouse gas emissions, NO_x, SO_x, or diesel particulate material (PM) during use. Air emission studies at the Port of San Francisco indicate that harbor craft, including ferries, are now the largest source of maritime air emissions at the Port of San Francisco. Widespread adoption of hydrogen fuel cell ferries would aid considerably the Port's efforts to further reduce maritime air emissions. Fuel cell technology would also eliminate the risk of fuel spills on the Bay.

Additionally, the envisioned vessel would be dramatically quieter than current diesel boats, providing a better experience for passengers and visitors to our waterfront.

As the world's center of technology development, the City and County of San Francisco and San Francisco Bay itself provide the ideal locale for the development, testing, and hopefully future deployment of such vessels. Should they prove feasible and be deployed, they have the potential to provide the Bay Area and the country with an entirely new green industry. We strongly support this project and we look forward to continuing to be a part of your effort as the project develops.

Sincerely,

Monique Moyer
Director, San Francisco Port

Cc: Thomas Escher, Red & White Fleet



SF Environment

Our home. Our city. Our planet.

A Department of the City and County of San Francisco

Edwin M. Lee

Mayor

Deborah O. Raphael
Director

March 30, 2015

Dr. Lennie Klebanoff
Sandia National Laboratories
7011 East Avenue
Livermore, CA 94551

Dear Dr. Klebanoff,

Thank you for taking time to visit with us here at the San Francisco Department of the Environment. My colleagues and I enjoyed learning about your vision of the Red and White Fleet to bring hydrogen fuel cell technology to the San Francisco Bay in the form of a fuel cell ferry.

A fuel cell-powered ferry would have many environmental benefits. As a zero-emission ferry, it would release no air pollutants, and with the prospect of renewably produced hydrogen, the ferry together with its fuel could be nearly free of greenhouse gas emissions, including the fuel's production cycle. In addition, a fuel cell ferry would be dramatically quieter than diesel technology, which is good for the ferry-travelling public and for our marine life as well. We also like the idea of completely eliminating diesel fuel spills in the Bay from such watercraft.

I understand that you currently have a proposal submitted to the Maritime Administration (MARAD) to perform an in-depth feasibility study of the fuel cell ferry, which would include investigating the hydrogen infrastructure requirements and hydrogen supply. I hope that proposal is successful, and we are looking forward to your assessment of the prospects for generating the hydrogen by carbon-neutral methods and with renewable sources so that the GHG reductions are maximized.

If your study indicates the project would be feasible, we would welcome the opportunity to consider ways in which we could support your team's effort to secure funding for the remainder of the project in which the fuel cell ferry and its associated hydrogen station would be designed, built, certified and deployed for use on the San Francisco Bay. In December, 2014, San Francisco was designated by the White House as a "Climate Action Champion", and as such, the City's association with the fuel cell ferry project could provide an advantage in winning federal grant awards that may be applicable to the project.

The development of a hydrogen fuel cell ferry is in keeping with San Francisco's tradition of establishing some of the most aggressive climate and sustainability targets in the nation, and in promoting the technology needed to meet those targets. We wish you every success.

Sincerely,

Deborah O. Raphael

Deborah O. Raphael
Director



February 11, 2016

Joseph W. Pratt, Ph.D.
Energy Innovation Department
Sandia National Laboratories
7011 East Avenue
Livermore, CA 94551

Dear Dr. Pratt:

When I last wrote to you back in February of 2015, you were just beginning your feasibility study for a high-speed (35-knot) passenger ferry powered by hydrogen fuel cell technology (nicknamed the SF-Breeze) for operation in the San Francisco Bay. At that time, I offered my strong support for your project.

The SF-Breeze, if proved feasible and subsequently constructed by Red & White Fleet, would aid considerably the Port's efforts to further reduce maritime pollutant emissions because the vessel would produce no greenhouse gas emissions, NO_x, SO_x or diesel particulate material (PM) during use. With widespread adoption, the SF-Breeze fuel cell technology would also eliminate the risk of fuel spills on the Bay, and be dramatically quieter, providing a better experience for passengers and visitors to our waterfront. All of these benefits support the Port's environmental objectives and also align with the City of San Francisco's promotion of "green technology" and its economic benefit to our area.

The Port of San Francisco remains strongly supportive of your project. We are delighted that you have found the SF-Breeze to be technically feasible with regard to the vessel itself, the landside hydrogen refueling facility, hydrogen supply and U.S. Coast Guard and ABS requirements. Rich Berman and the Port of San Francisco team have been working with you and the Red and White Fleet to identify locations at the Port to berth and fuel the vessel, and it appears several of them meet your requirements and look promising from the Port's perspective as well. In addition, these sites lend themselves to the dual use of the SF-Breeze hydrogen refueling facility to enable zero-emission fuel-cell cars, trucks and buses, which complements the State of California's promotion of hydrogen fuel cell vehicles and amplifies the environmental benefit of the SF-Breeze to the City of San Francisco.

The Port looks forward to further discussions with you to identify the best refueling/berthing location and are pleased to continue our participation as this project develops further.

Sincerely,

Monique Moyer
Executive Director



Joseph W. Pratt, Ph.D.
Energy Innovation Department
Sandia National Laboratories
7011 East Avenue
Livermore, CA 94551

Dear Joe:

Thank you for meeting with us at the Bay Area Council. My colleagues and I enjoyed learning about your vision, with the Red & White Fleet, to build a high-speed passenger ferry powered by hydrogen fuel cell technology that would make water transit operations cleaner, quieter, and more efficient. The Bay Area Council, a non-profit public policy organization representing hundreds of the largest employers in the Bay Area, promotes the expansion of ferry service as a viable commute alternative to our region's increasingly congested highways and transit systems. We also promote the integration of alternative vessel technologies that enhance the efficiency and environmental sustainability of ferries.

Governor Brown and the California Legislature have set us on an ambitious path to decarbonizing the state's transportation system, and your proposal for a fuel cell-powered ferry would yield tremendous environmental benefits to meet those goals. We are very interested in your proposal to create a vessel that would produce no greenhouse gas emissions, NOx, SOx, or diesel particulate material during use. In addition, a fuel cell ferry would be dramatically quieter than diesel technology, and it would completely eliminate the risk of diesel fuel spills in the bay.

As a global innovation center, the Bay Area is the ideal location for the development, testing, and the potential future deployment of these vessels. If the vessel technology is proven, it has the potential to provide the Bay Area and the nation with an entirely new green industry. We look forward to continuing to be a part of your effort as the project develops.

Sincerely,

A handwritten signature in black ink, appearing to read 'John B. Grubb', written in a cursive style.

John Grubb
Chief Operating Officer
Bay Area Council



California Fuel Cell Partnership
3300 Industrial Blvd., Suite 1000
West Sacramento, CA 95691
(916) 371-2870

www.fuelcellpartnership.org
info@cafcp.org

Automotive Fuel Cell Cooperation
Daimler
GM
Honda
Hyundai
Nissan
Toyota
Volkswagen

Cal/EPA Air Resources Board
California Energy Commission
Office of Governor Edmund G. Brown Jr.
South Coast AQMD
U.S. Department of Energy
U.S. Environmental Protection Agency

Air Liquide
BAE Systems
Ballard Power Systems
FirstElement Fuel, Inc.
H2 Logic
Hydrogenics
HydrogNEXT
ITM Power
Linde North America, Inc.
Southern California Gas Company

AC Transit
Bay Area Air Quality Management District
CA Dept of Food and Agriculture
Cal State LA
CALSTART
CEERT
CTE
Energy Independence Now
NREL
Sandia National Laboratories
SunLine Transit Agency
University of California, Berkeley
UC Irvine-NFCRC
UC Davis-ITS

March 30, 2016

Mr. Joseph W. Pratt, Ph.D.
Energy Innovation Department
Sandia National Laboratories
7011 East Avenue
Livermore, CA 94551

Re: Sandia and Red and White Fleet High Speed Fuel Cell Ferry

Dear Dr. Pratt,

The California Fuel Cell Partnership is pleased to have Sandia National Laboratories as a member organization and we are delighted to hear about Red and White Fleet's intention to build a high-speed fuel cell passenger ferry (SF-Breeze) for operation in the San Francisco Bay.

Our organization is a private-public partnership of vehicle manufacturers, fuel infrastructure companies, fuel cell companies, government, academia, transit agencies and non-governmental organizations. As one of the world's leading hydrogen and fuel cell organizations, we actively collaborate to support fuel cell vehicle commercialization and help achieve California's goals for clean air, reduced greenhouse gases, and reduced petroleum use.

The operation of this ferry will require a large capacity liquid hydrogen fueling station, creating the potential benefit of co-located vehicle fueling. The implementation of such a station in the Bay Area is expected to have a variety of other benefits, such as lower cost of hydrogen fuel due to the base load fuel demand of the ferry.

We are in support of Red and White Fleet's initiative and all efforts contributing to fuel cost reduction and expansion of the fueling infrastructure. We expect this project will be a key step towards commercially sustainable deployment of zero emission fuel cell applications in maritime vessels for public transportation.

Please do not hesitate to contact me or my staff if you have any questions.

Best regards,

Bill Elrick
Executive Director



GAVIN NEWSOM
LIEUTENANT GOVERNOR

September 9, 2016

Joseph W. Pratt, Ph.D.
7011 East Avenue
Livermore CA 94551

RE: SF-BREEZE

Dear Joe,

I was recently briefed by Tom Escher, President of the Red and White Fleet, on the results of the feasibility study you have led for a zero-emission high-speed (35-knot) passenger ferry powered by hydrogen fuel cell technology (nicknamed the SF-BREEZE) for operation on the San Francisco Bay. I am extremely enthusiastic about this project. The SF-BREEZE would aid considerably the State of California's efforts to reduce both greenhouse gas and criteria pollutant emissions. The hydrogen fuel-cell technology would also completely eliminate the risk of fuel spills, and be dramatically quieter, providing a better experience for passengers and protecting our marine life as well. Beyond those environmental objectives, I see the SF-BREEZE as the beginnings of a new maritime industry in California, bringing together traditional ship building with the superior technology innovation for which we have always been known. All of these benefits align with our environmental and economic objectives for the State.

I was delighted to hear that you've found the SF-BREEZE to be technically feasible with regard to the vessel itself, the hydrogen refueling facility, hydrogen supply and the Coast Guard requirements. Tom described how the Port of San Francisco has been working with you and the Red and White Fleet to identify SF Port locations to berth and fuel the vessel, and it appears Pier 54 fulfills everybody's requirements. Importantly, this hydrogen refueling location can also serve zero-emission fuel-cell cars and eventually fuel-cell trucks and buses. The CA Air Resources Board has identified San Francisco as very much in need of a hydrogen station to fuel light-duty fuel cell cars which are coming to market. In this way, your vision for a dual-use (maritime vessels, cars) hydrogen station amplifies the broader environmental benefit of the SF-BREEZE to the City of San Francisco and the State of California in a highly synergistic way.

I want to see this vision realized, both as a hydrogen station at the Port of San Francisco serving fuel-cell vehicles and vessels and in the construction and commissioning of the SF-BREEZE itself. I am directing my staff to support this effort to bring this vision to a reality.

Sincerely,

A handwritten signature in black ink, appearing to read "Gavin Newsom", written over a white background.

Gavin Newsom
Lt. Governor of California





To Whom It May Concern:

The Port of San Francisco has long been a steward of the San Francisco Bay and its environs. We recognize that forces acting on the ecology and economy of our planet have no boundaries and the broadest of implications. It is with awareness to the issue of climate change that we support a bold transition away from fossil fuels and towards zero-emission transportation technologies. In this spirit we support the California Energy Commission initiative to fund the development of hydrogen fueling stations in the state (GFO 15-605 -Hydrogen Fuel Infrastructure).

The Port of San Francisco is a public enterprise agency whose core mission includes a premium on maritime activities. As such, our vision for the development of alternative fuels on Port property has always been that they can support maritime as well as land-based activities. Grant applicants that are interested in developing a hydrogen fueling station at the Port of San Francisco should understand our vision and what is feasible for us.

For the past eighteen months Sandia National Laboratories has been analyzing the feasibility of a hydrogen fuel cell passenger ferry called the SF-BREEZE. Initiated at the behest of one of our long-term maritime tenants, the project was funded by the U.S. Department of Transportation's Maritime Administration. It is now clear that such a vessel is feasible and could be refueled from Port property. Our vision for hydrogen refueling on Port property is to co-locate a light-duty vehicle hydrogen station with a refueling station for the SF-BREEZE. Such an intermodal hydrogen fueling station would be the first of its kind anywhere in the world. To be consistent with our vision the project would need to conform to the following requirements:

1. Because liquid hydrogen (LH2) is needed for a high-speed ferry, the station would use LH2 as the principal means of hydrogen storage at the site. Compressed hydrogen could also be incorporated to fuel ground vehicles.
2. The storage of LH2 is flexible, but we consider the two best options to be a permanent on-site LH2 tank, or the delivery and exchange of LH2 trailers.
3. A hydrogen station on Port property must include proximity to the water at a location with sufficient depth to accommodate a ferry and other vessels. We have already investigated potential Port locations, and we have found several sites that seem to satisfy fuel cell vehicle refueling and eventual maritime refueling.

4. The hydrogen supplied to the station would require an explicit path to 100% renewable hydrogen, rather than hydrogen produced from conventional fossil fuels.

The Port of San Francisco enthusiastically supports the creation of an intermodal hydrogen fueling station on Port property. The proximity of Port property to the high population density of San Francisco would make a Port-based hydrogen station valuable in many respects. We are aware that the California Air Resources Board has identified San Francisco as a major “gap” location between the expected demand for hydrogen fuel cell vehicles and hydrogen supply. An intermodal fueling station at the Port location would help fill this gap and serve to bridge the technology to the maritime community.

We urge the State of California to consider the Port of San Francisco’s vision when reviewing grant applications for hydrogen fueling stations on Port property. For any questions or clarifications, please contact Richard Berman (415) 274-0276 / richard.berman@sfport.com.

Sincerely,



Elaine Forbes
Interim Executive Director

Distribution

- 4 U.S. Department of Transportation, Maritime Administration
Attn: Sujit Ghosh
Attn: Michael Carter
Attn: John Quinn
Attn: Paul “Chip” Jaenichen
MAR-410, W28-216
1200 New Jersey Ave SE
Washington, D.C. 20590

- 2 Red and White Fleet
Attn: Thomas C. Escher
Attn: Joe Burgard
Pier 45 Shed C
San Francisco, California 94133

- 2 Elliott Bay Design Group
Attn: John Waterhouse
Attn: Curt Leffers
5305 Shilshole Ave NW, Suite 100
Seattle, WA 98107

- 2 Port of San Francisco
Attn: Elaine Forbes
Attn: Rich Berman
Pier 1, The Embarcadero
San Francisco, CA 94111

- 3 US Coast Guard, Design and Engineering Standards
Attn: Tim Meyers
Attn: Thane Gilman
Attn: LT Paul “PJ” Folino
USCG HQ (ENG-3)-Room 5R19
2703 Martin Luther King Jr. Ave. SE
Washington DC 20593-7509

- 3 US Coast Guard, Marine Safety Center
Attn: CDR Sean Brady
Attn: LT Kate Woods
Attn: LT Margaret Woodbridge
US Coast Guard Stop 7430
2703 Martin Luther King Jr. Ave SE
Washington DC 20593-7430

- 3 US Coast Guard, Sector San Francisco

Attn: CDR Jennifer Stockwell
Attn: Hannah Reeves
Attn: LT Mike Wu
Domestic Vessel Inspections
1 Yerba Buena Road, Bldg. 25
San Francisco, CA 94130

3 US Coast Guard, Liquefied Gas Carrier National Center of Expertise
Attn: CDR Jason Smith
Attn: CDR Dallas Smith
Attn: Scott Mercurio
2901 Turtle Creek Drive
Port Arthur, TX 77642

3 American Bureau of Shipping
Attn: Emil Shtaygrud
Attn: Steve O'Day
Attn: Roshan Jacob
16855 Northchase Drive
Houston, TX 77060

1 U.S. Department of Energy
Attn: Peter Devlin
1000 Independence Ave., SW
Washington, D.C. 20585-0121

1	MS0748	Chris LaFleur	06231 (electronic copy)
1	MS9052	Tom Felter	08366 (electronic copy)
2	MS9052	Joseph W. Pratt	08366
1	MS9054	Bob Hwang	08300 (electronic copy)
1	MS9054	Chris Moen	08360 (electronic copy)
1	MS9161	Jon Zimmerman	08367 (electronic copy)
2	MS9161	Lennie Klebanoff	08367
1	MS9161	Chris San Marchi	08367 (electronic copy)
1	MS0899	Technical Library	09536 (electronic copy)
1	MS9018	Central Technical Files	08944



Sandia National Laboratories